

STELLA-HB-WWW

~100° very wide beam for warehouse and outdoor lighting. Compatible with up to 30 mm LES size COBs.

TECHNICAL SPECIFICATIONS:

Dimensions	Ø 90.0 mm
Height	11.3 mm
Fastening	screw
Colour	black
Box size	480 x 280 x 300 mm
Box weight	5 kg
Quantity in Box	135 pcs
ROHS compliant	yes ⓘ



MATERIAL SPECIFICATIONS:

Component	Type	Material	Colour
STELLA-HB-WWW	Single lens	Silicone	clear
STELLA-FRAME	Holder	PA66	black

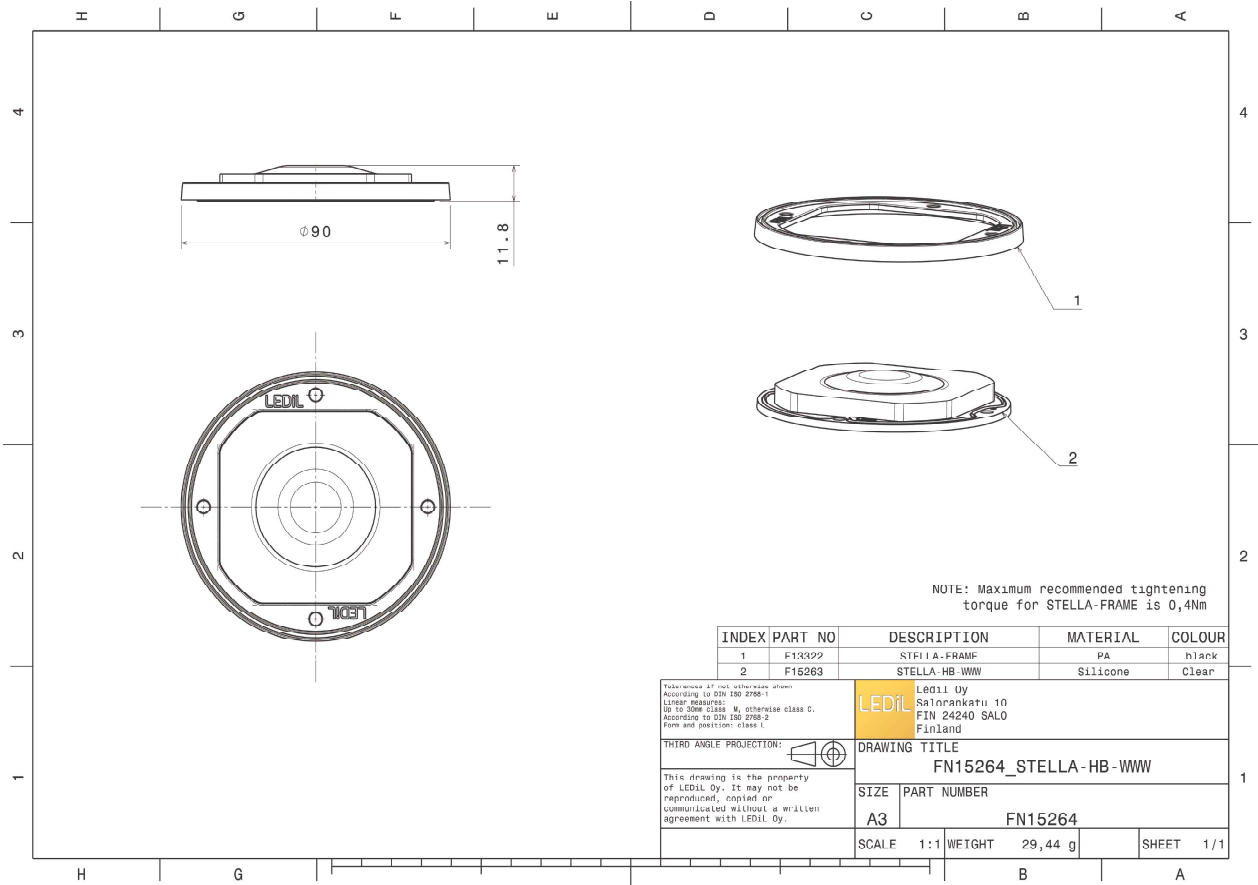

PHOTOMETRIC DATA (MEASURED):

CITIZEN

LED CLL02x/CLU02x (LES10)
FWHM 100.0°
Efficiency 88 %
Peak intensity 0.370 cd/lm
LEDs/each optic 1
Light colour White
Required components:

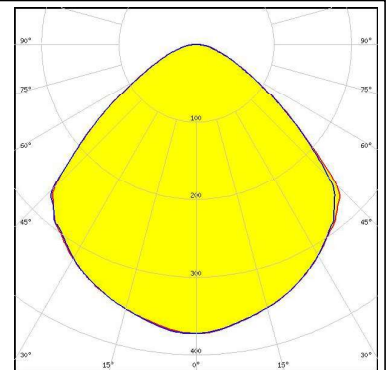
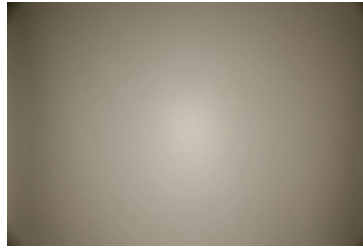

CITIZEN

LED CLL04x/CLU04x
FWHM 102.0°
Efficiency 89 %
Peak intensity 0.360 cd/lm
LEDs/each optic 1
Light colour White
Required components:

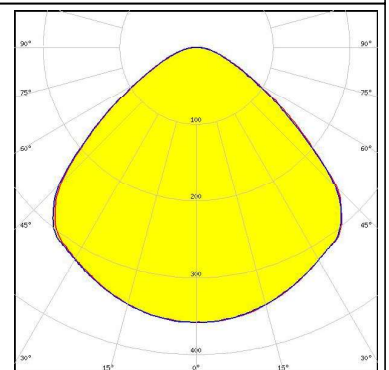
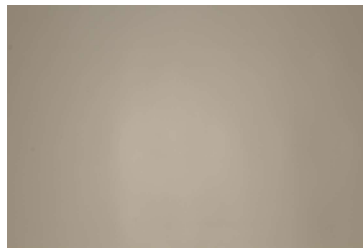

CREE

LED CMA2550
FWHM 102.0°
Efficiency 88 %
Peak intensity 0.400 cd/lm
LEDs/each optic 1
Light colour White
Required components:

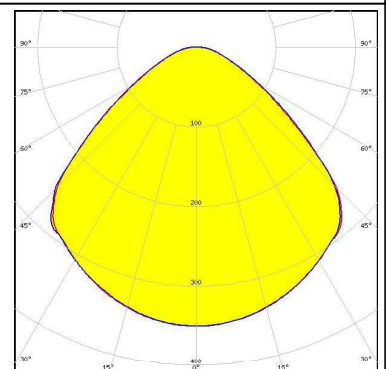
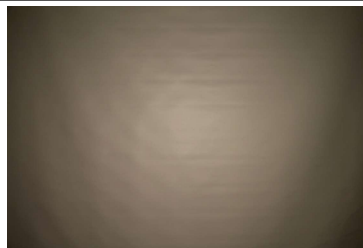

CREE

LED CMA3090
FWHM 102.0°
Efficiency 88 %
Peak intensity 0.300 cd/lm
LEDs/each optic 1
Light colour White
Required components:

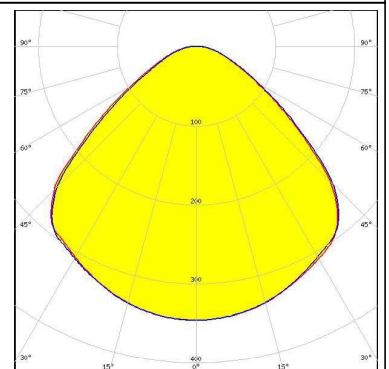
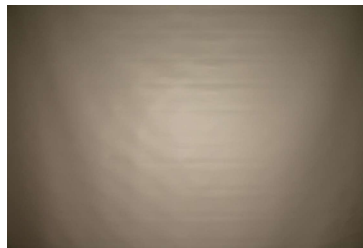

PHOTOMETRIC DATA (MEASURED):



LED CXA/B 1816 & CXA/B 1820 & CXA 1850
 FWHM 102.0°
 Efficiency 87 %
 Peak intensity 0.350 cd/lm
 LEDs/each optic 1
 Light colour White
 Required components:

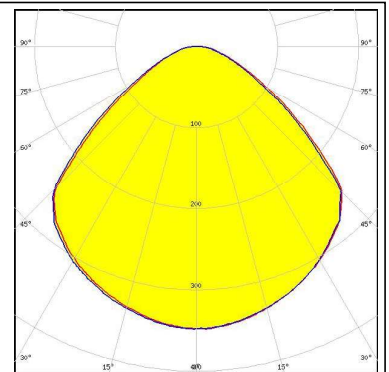
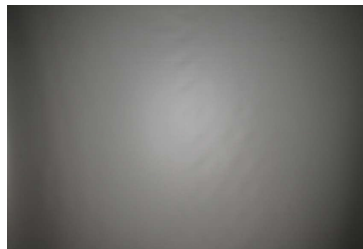

LED CXA/B 1830
 FWHM 102.0°
 Efficiency 88 %
 Peak intensity 0.350 cd/lm
 LEDs/each optic 1
 Light colour White
 Required components:
 C14305_STELLA-CLAMP-CXA15-18

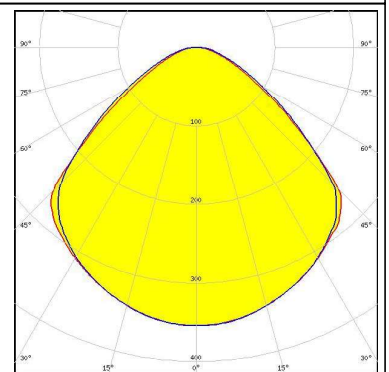
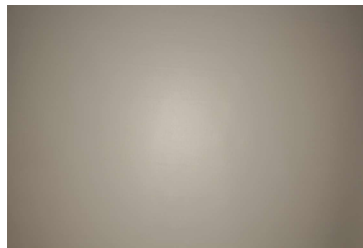

LED CXA/B 25xx
 FWHM 101.0°
 Efficiency 90 %
 Peak intensity 0.400 cd/lm
 LEDs/each optic 1
 Light colour White
 Required components:
 Bender Wirth: 439 Typ L3

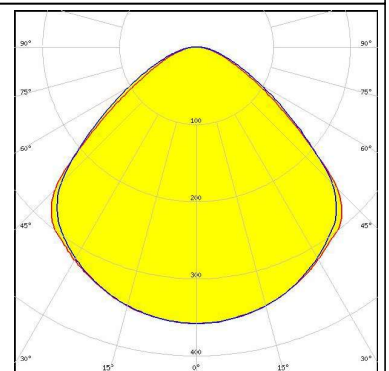
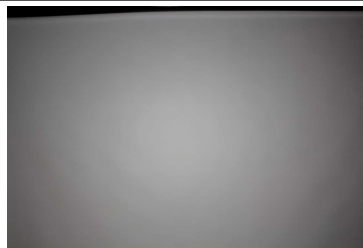

LED CXA/B 25xx
 FWHM 102.0°
 Efficiency 88 %
 Peak intensity 0.350 cd/lm
 LEDs/each optic 1
 Light colour White
 Required components:

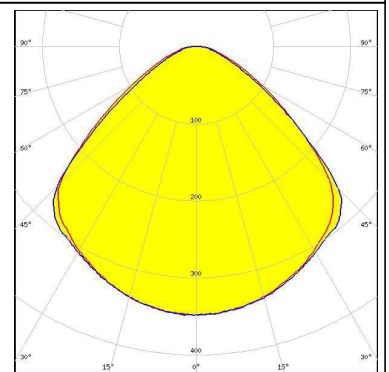
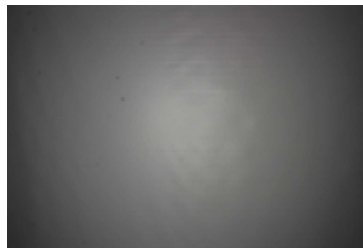

PHOTOMETRIC DATA (MEASURED):



LED CXA/B 30xx
 FWHM 102.0°
 Efficiency 88 %
 Peak intensity 0.350 cd/lm
 LEDs/each optic 1
 Light colour White
 Required components:

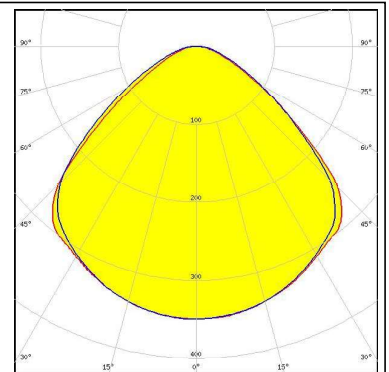
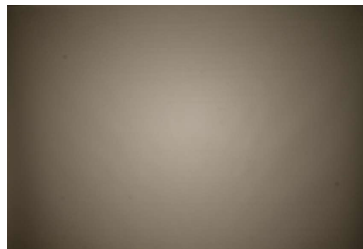

LED CXA/B 3590
 FWHM 102.0°
 Efficiency 90 %
 Peak intensity 0.360 cd/lm
 LEDs/each optic 1
 Light colour White
 Required components:

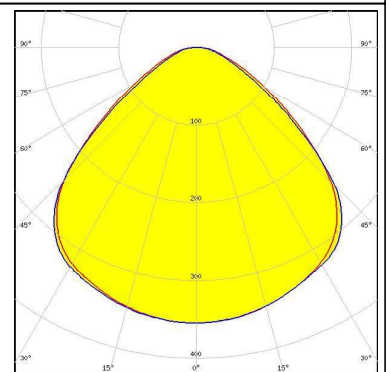

LED LUXEON CoB 1211
 FWHM 101.0°
 Efficiency 89 %
 Peak intensity 0.360 cd/lm
 LEDs/each optic 1
 Light colour White
 Required components:
 Bender Wirth: 431 Typ L3

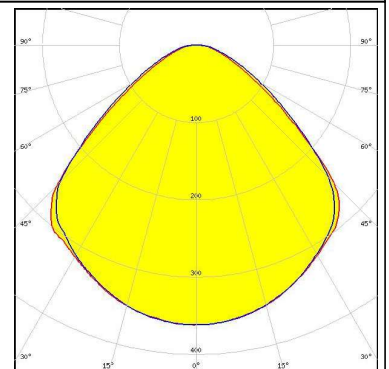
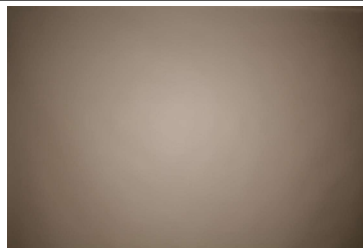

LED LUXEON CoB 1321
 FWHM 102.0°
 Efficiency 89 %
 Peak intensity 0.340 cd/lm
 LEDs/each optic 1
 Light colour White
 Required components:

