

DETAILS

Product Number	C12362_STRADA-2X2-DWC
Family	Strada-Module
Type	Lens array
Color	clear
Diameter	50x50 mm
Height	6 mm
Style	square
Optic Material	PMMA
Holder Material	
Fastening	glue, pin, screw
Status	production ready
ROHS Compliant	Yes
Date Updated	23/11/2016



OPTICAL PROPERTIES

LED	Viewing Angle	Light Beam	Efficiency	cd/lm	Connector
XM-L	Asymmetric deg	Streetligh...	92 %	0.410	-
XT-E	Asymmetric deg	Streetligh...	93 %	0.490	-
XP-G	Asymmetric deg	Streetligh...	93 %	0.470	-
XT-E HVW	Asymmetric deg	Streetligh...	-	-	-
XQ-E	sim: Asymmetric	Streetligh...	sim: 89 %	-	-
XM-L2	sim: Asymmetric	Streetligh...	-	-	-
XP-G2	asymmetric deg	Streetligh...	94 %	0.700	-
XP-L	Asymmetric deg	Streetligh...	94 %	0.510	-
XP-L HI	asymmetric deg	Streetligh...	94 %	0.610	-
XHP35 HD	Asymmetric deg	Streetligh...	94 %	0.440	-
XHP35 HI	sim: Asymmetric	Streetligh...	sim: 89 %	sim: 0.520	-
XP-G3	Asymmetric deg	Streetligh...	94 %	0.600	-
XP-L2	Asymmetric deg	Streetligh...	94 %	0.480	-
H35C0 (LEMWA33)	Asymmetric deg	Streetligh...	94 %	0.500	-
H35C1 (LEMWA33)	Asymmetric deg	Streetligh...	94 %	0.670	-
LUXEON Rebel ES	Asymmetric deg	Streetligh...	93 %	0.410	-
LUXEON T	Asymmetric deg	Streetligh...	93 %	0.700	-
LUXEON H50-2	sim: Asymmetric	Streetligh...	-	-	-
LUXEON Q	asymmetric deg	Streetligh...	94 %	0.700	-
LUXEON TX	asymmetric deg	Streetligh...	94 %	0.670	-
LUXEON MZ	asymmetric deg	Streetligh...	94 %	0.600	-
LUXEON 5050	Asymmetric deg	Streetligh...	94 %	0.460	-
NS9x383	Asymmetric deg	Streetligh...	95 %	0.490	-
NVSxx19B/NVSxx19C	Asymmetric deg	Streetligh...	94 %	0.650	-
NWSx229A	Asymmetric deg	Streetligh...	94 %	0.480	-



PRODUCT DATASHEET

Strada-Module series

last update 23/11/2016

OPTICAL PROPERTIES

LED	Viewing Angle	Light Beam	Efficiency	cd/lm	Connector
NVSW3x9A	asym deg	Streetligh...	94 %	0.590	-
NVSE21A	asym deg	Streetligh...	94 %	0.870	-
Oslon Square PC	Asymmetric deg	Streetligh...	92 %	0.600	-
Duris S8	sim: Asymmetric	Streetligh...	sim: 90 %	sim: 0.460	-
Oslon Square Gen3	Asymmetric deg	Streetligh...	94 %	0.670	-
Duris P8	sim: Asymmetric	Streetligh...	sim: 90 %	sim: 0.610	-
Fortimo FastFlex LED board 2x8 DA G4	asymmetric deg	Streetligh...	94 %	0.640	-
LH351B	Asymmetric deg	Streetligh...	89 %	0.620	-
LH351Z	asymmetric deg	Streetligh...	94 %	0.650	-
LH351D	Asymmetric deg	Streetligh...	94 %	0.450	-
Z5	Asymmetric deg	Streetligh...	93 %	-	-
Acrich MJT 4040	Asymmetric deg	Streetligh...	94 %	0.600	-
Z5M1/Z5M2	asymmetric deg	Streetligh...	94 %	0.700	-
Z8Y22P	Asymmetric deg	Streetligh...	94 %	0.600	-
TL1L4	Asymmetric deg	Streetligh...	93 %	0.720	-
RLE G1 49x223mm 4000lm xxx EXC OT	Asymmetric deg	Streetligh...	94 %	0.700	-
RLE G1 49x245mm 4000lm xxx EXC OT	Asymmetric deg	Streetligh...	94 %	0.700	-
RLE G1 49x121mm 2000lm xxx EXC OT	Asymmetric deg	Streetligh...	94 %	0.700	-
RLE G1 49x133mm 2000lm xxx EXC OT	Asymmetric deg	Streetligh...	94 %	0.700	-

D

C

B

A

4

4

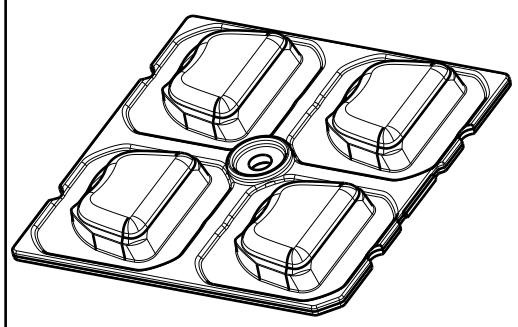

Isometric view

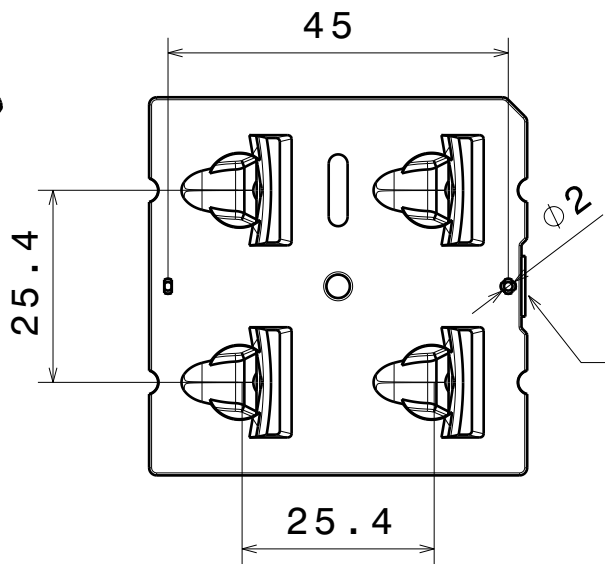

Bottom view

Position pins

3

3

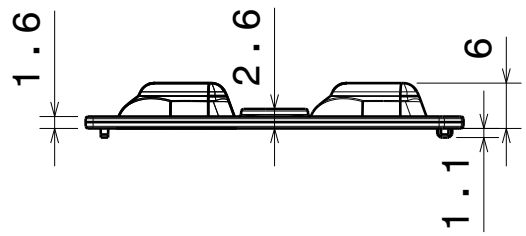

Front view

2

2

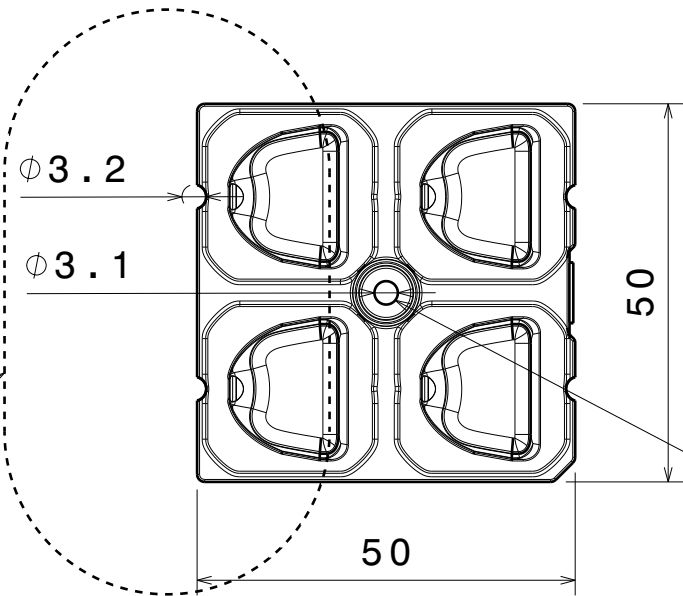

Top view

Beam direction (street side)

Screw hole

INDEX	PART NO	DESCRIPTION	MATERIAL	COLOUR
1	C12362	STRADA-2X2-DWC	PMMA	clear

Tolerances if not otherwise shown
 According to DIN ISO 2768-1
 Linear measures:
 up to 30mm class M, otherwise class C
 According to DIN ISO 2768-2
 Form and position: class L

LEDiL LediL Oy
 Salorankatu 10
 FIN 24240 SALO
 Finland

THIRD ANGLE PROJECTION:

DRAWING TITLE
C12362_STRADA-2X2-DWC

This drawing is the property of LEDiL Oy. It may not be reproduced, copied or communicated without a written agreement with LEDiL Oy.

SIZE	PART NUMBER
A4	C12362

SCALE	1:1	WEIGHT	6,1	SHEET	1/1
-------	-----	--------	-----	-------	-----

D

A

1

Luminaire: Ledil Oy C12362_STRADA-2X2-DWC (Cree XT-E AWT 409lm @ 250mA)
Lamps: 1 x Cree XT-E AWT 409lm @ 250mA

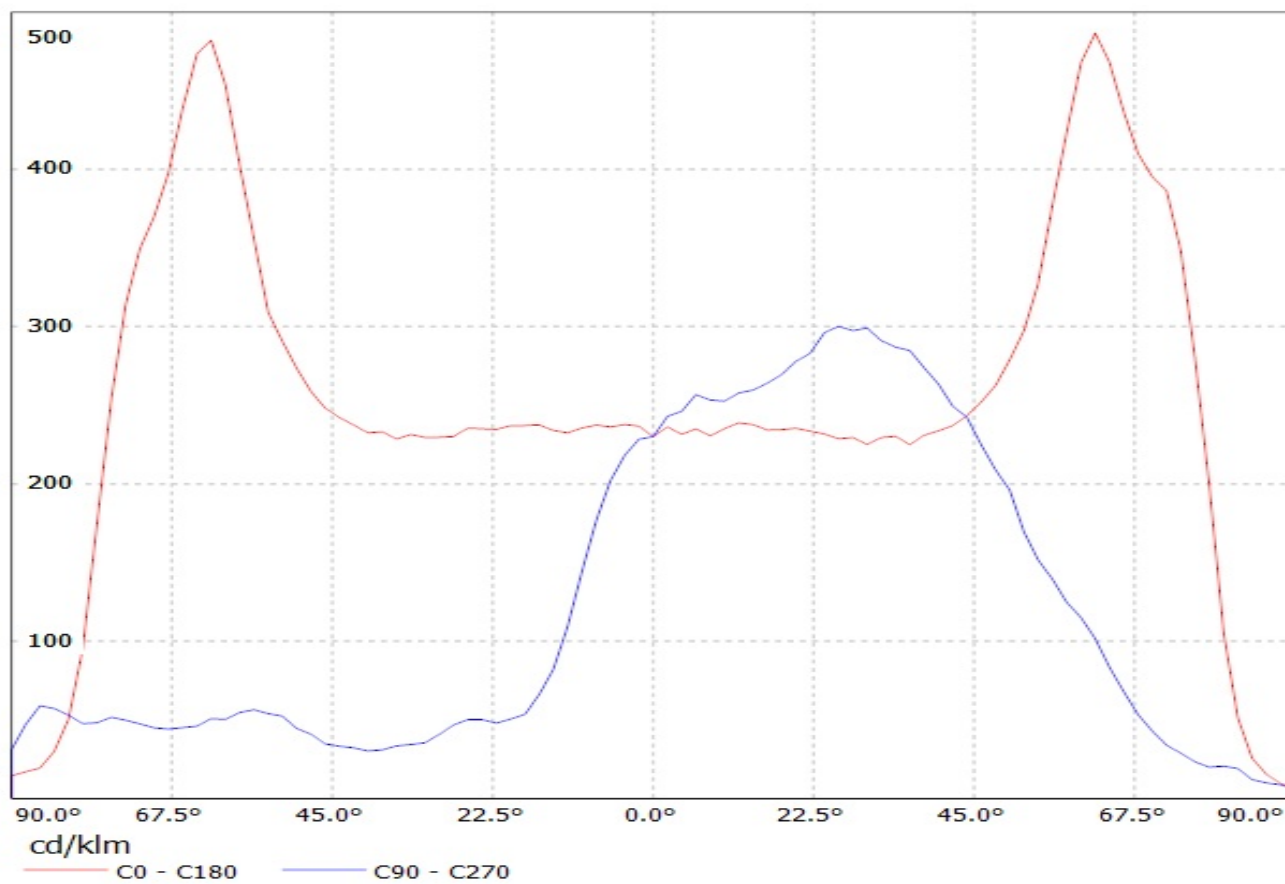

Luminaire: LEDil Oy C12362_STRADA-2X2-DWC_(XP-G2) Efficiency=94%
Lamps: 1 x Cree XP-G2 (XPGBWT-L1-00-00G51) 350lm @ 250mA CCT=7200K P=2.9W I=250mA

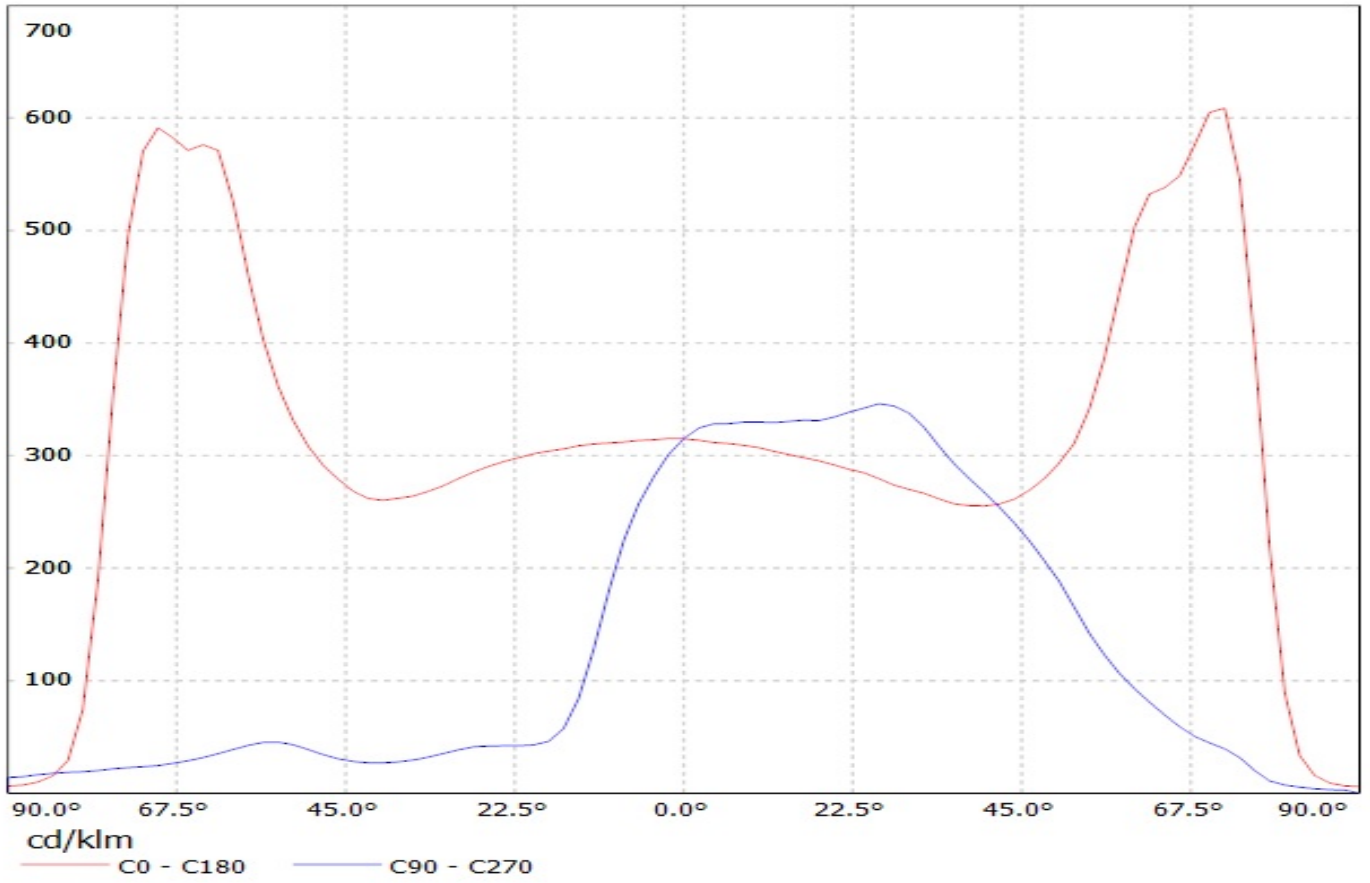

Luminaire: LEDiL Oy C12362_STRADA-2X2-DWC (XP-L) Eff.94.2%

Lamps: 1 x CREE_XP-L_2x2_(XPLAWT-0-1B0-V40-00-0001)_504.373lm@250mA_CCT=7600K_P=2.79963W_I=249.9mA

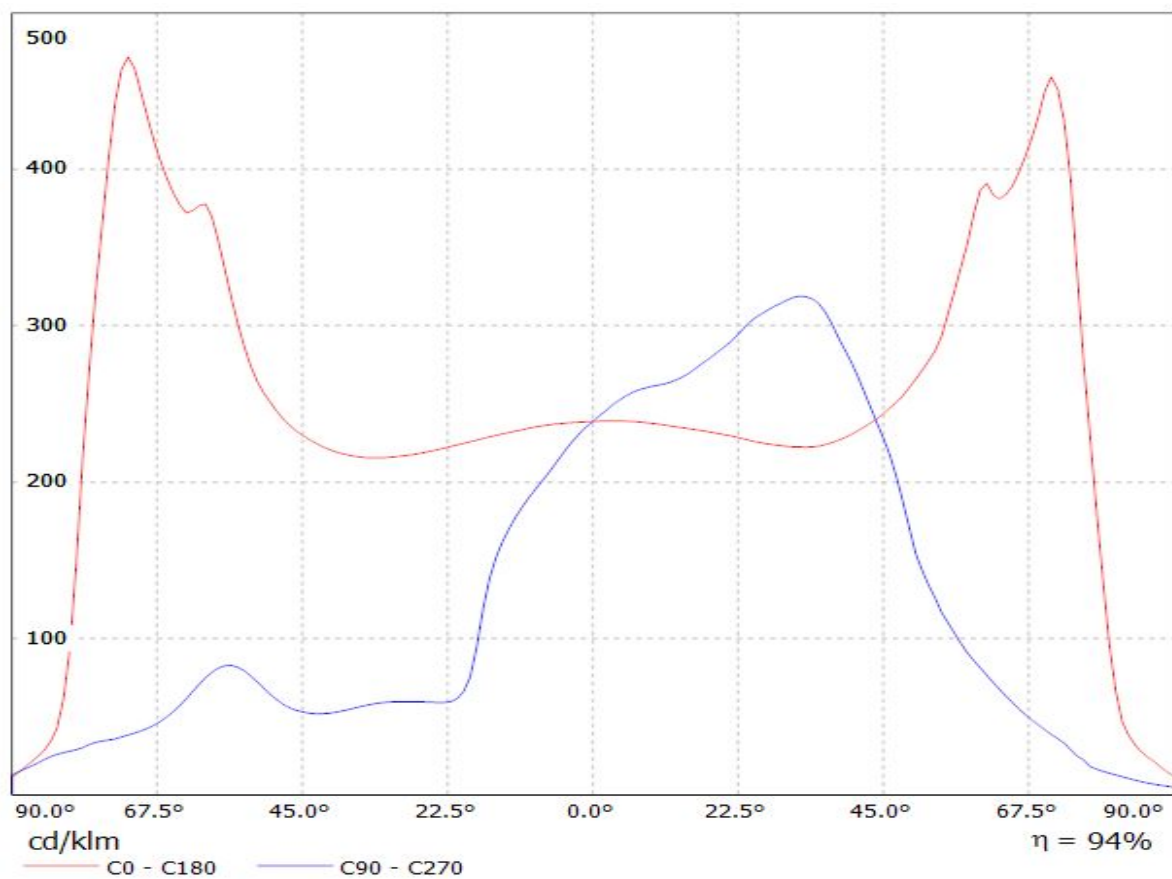

Luminaire: LEDiL Oy C12362_STRADA-2X2-DWC_(XP-L_HI)
Lamps: 1 x Cree_XP-L_HI_(2x2)_(XPLAWT-H-5A3-U60-013-0001)
_455.077lm@250mA_P=2.84011W_I=0.2499A

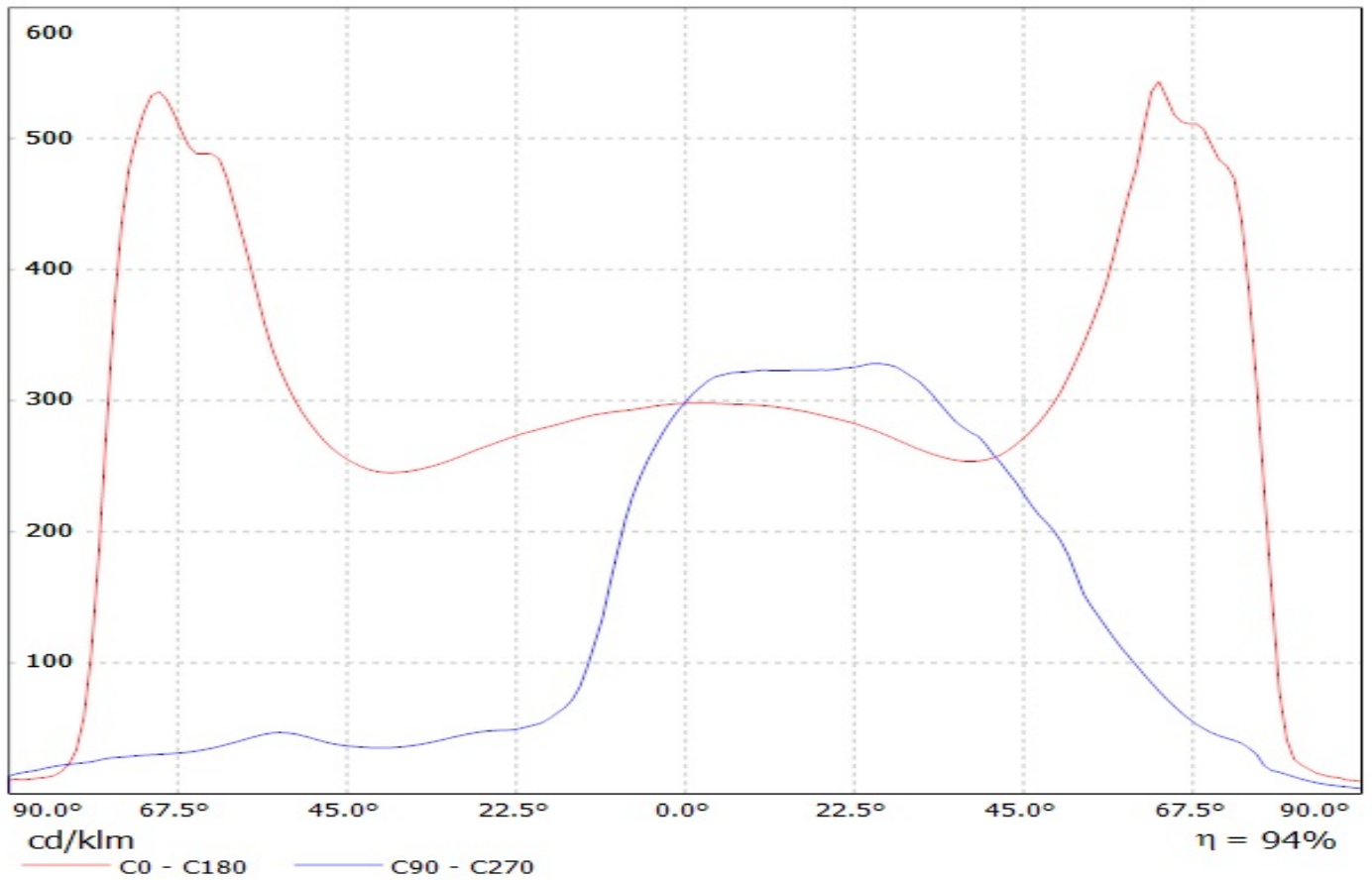

Luminaire: Ledil C12362_STRADA-2X2-DWC_(XHP35)
Lamps: 1 x Cree_XHP35-HD_2x2_(XHP35A-0-50E-D40-D0-H-01)
_1743.3lm@250mA_P=11.4855W_I=0.25A

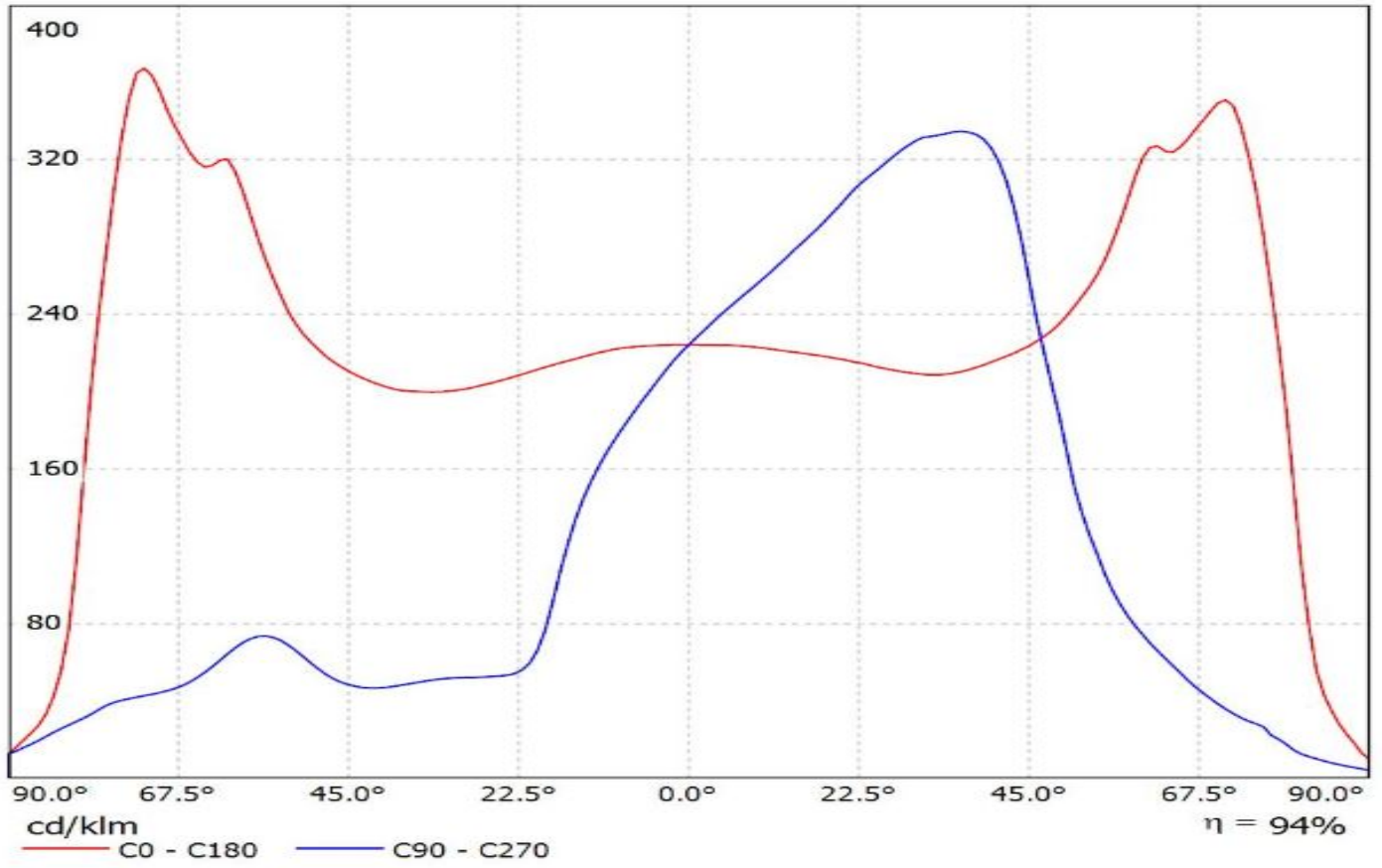

Luminaire: Ledil Oy C12362_STRADA-2X2-DWC_(XHP35_HI)_SIMULATED
Lamps: 1 x CREE XHP35 HI

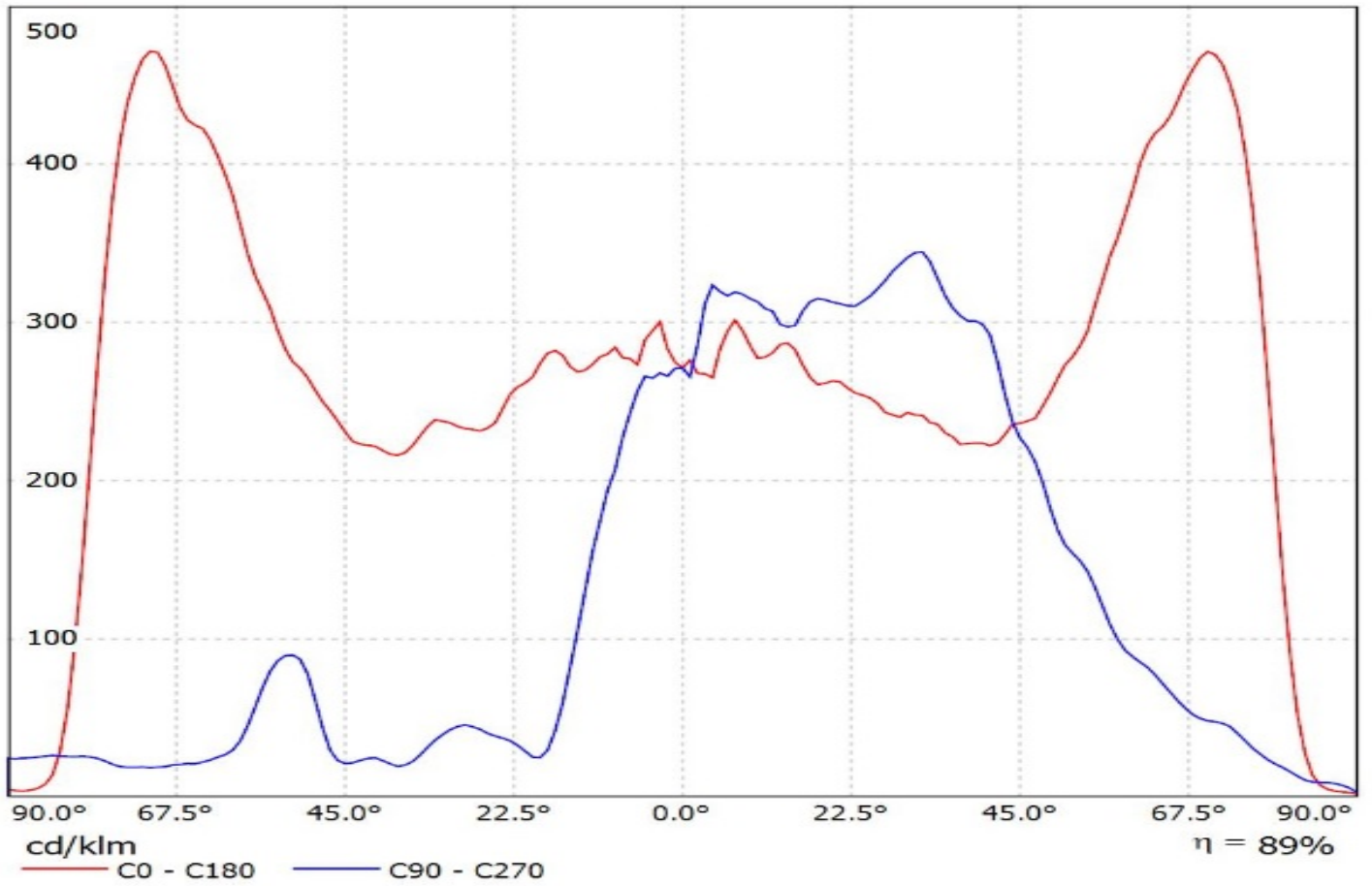

Luminaire: LEDiL Oy C12362_STRADA-2X2-DWC_(XP-G3)

Lamps: 1 x XP-G3_(XPWDWTT-B1-3C0-S4-0-01)_501.192lm@250mA_P=2.76903W_I=0.250A

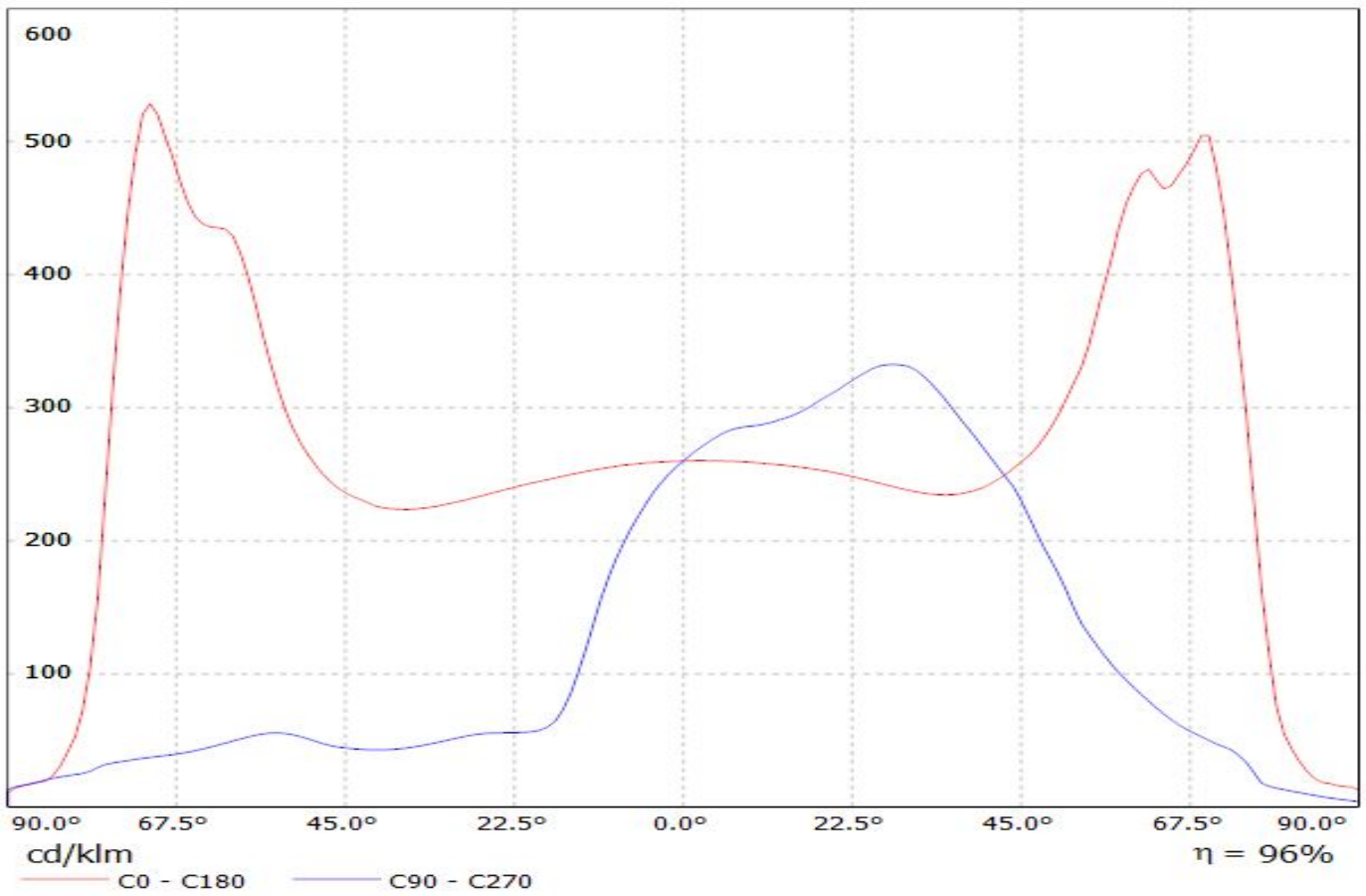

Luminaire: Ledil C12362_STRADA-2X2-DWC_(XP-L2)

Lamps: 1 x Cree_XP-L2_2x2_(XPLBWT-00-0000-000BV50E3)550.93lm@250mA_P=2.7815W_I=0.25A

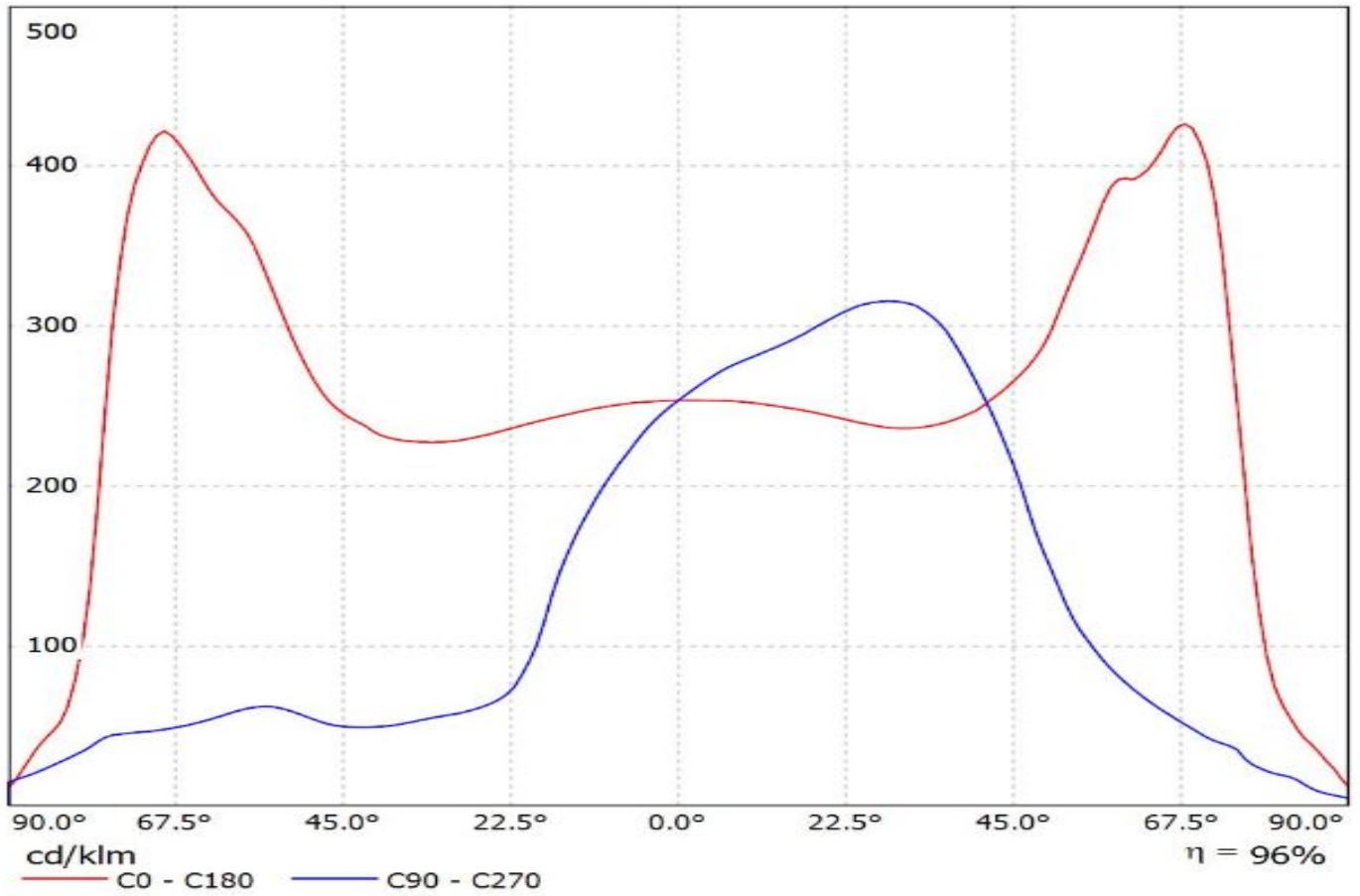

Luminaire: LEDiL Oy C12362_STRADA-2X2-DWC_(LG3535) Eff. 93,8%
Lamps: 1 x LG Ceramic 3535 PKG (372lm@250mA)

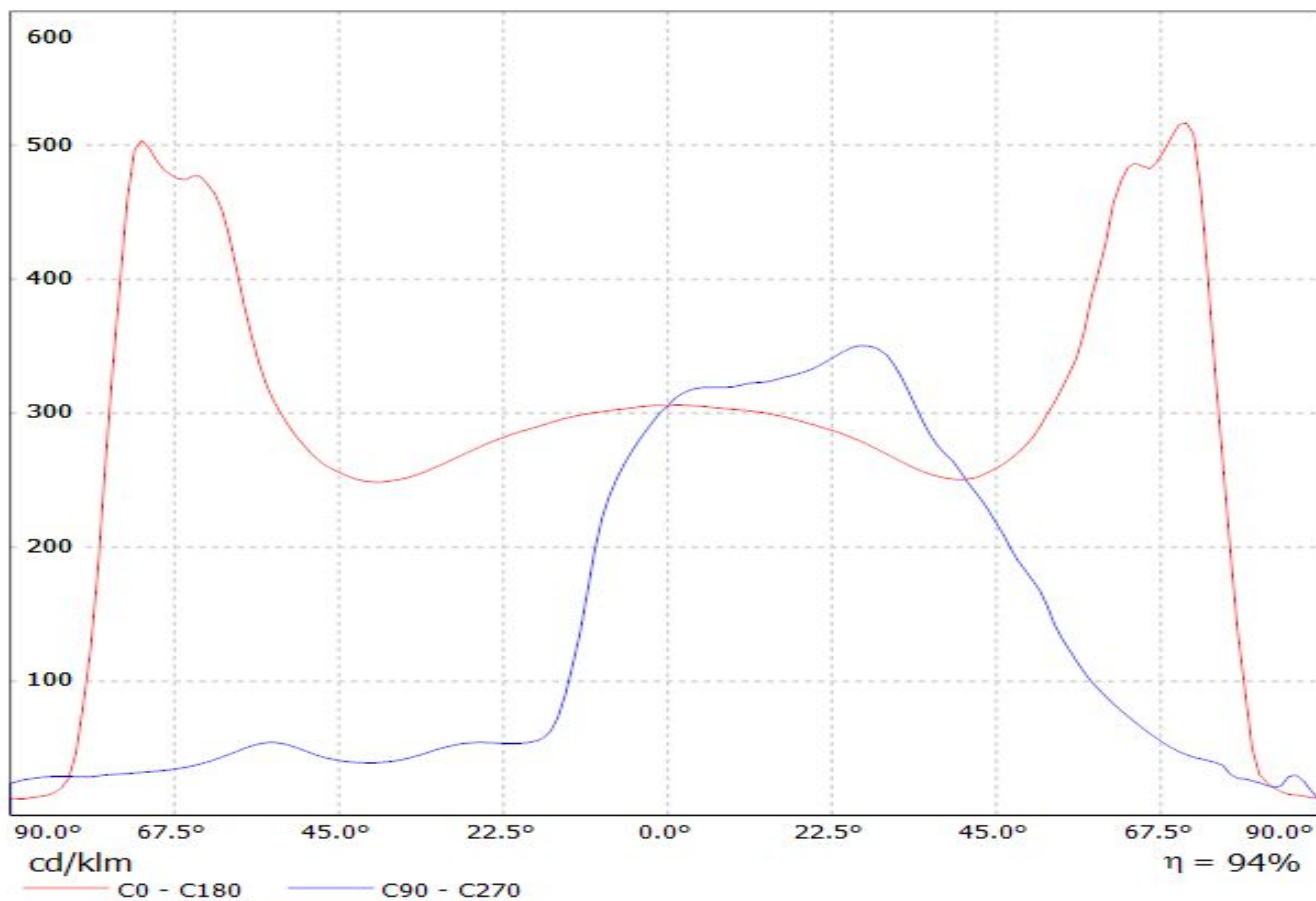

Luminaire: Ledil C12362_STRADA-2X2-DWC_(H35C1)
Lamps: 1 x LG_H35C1_2x2_477.216lm@250mA_P=2.87475W_I=0.250A

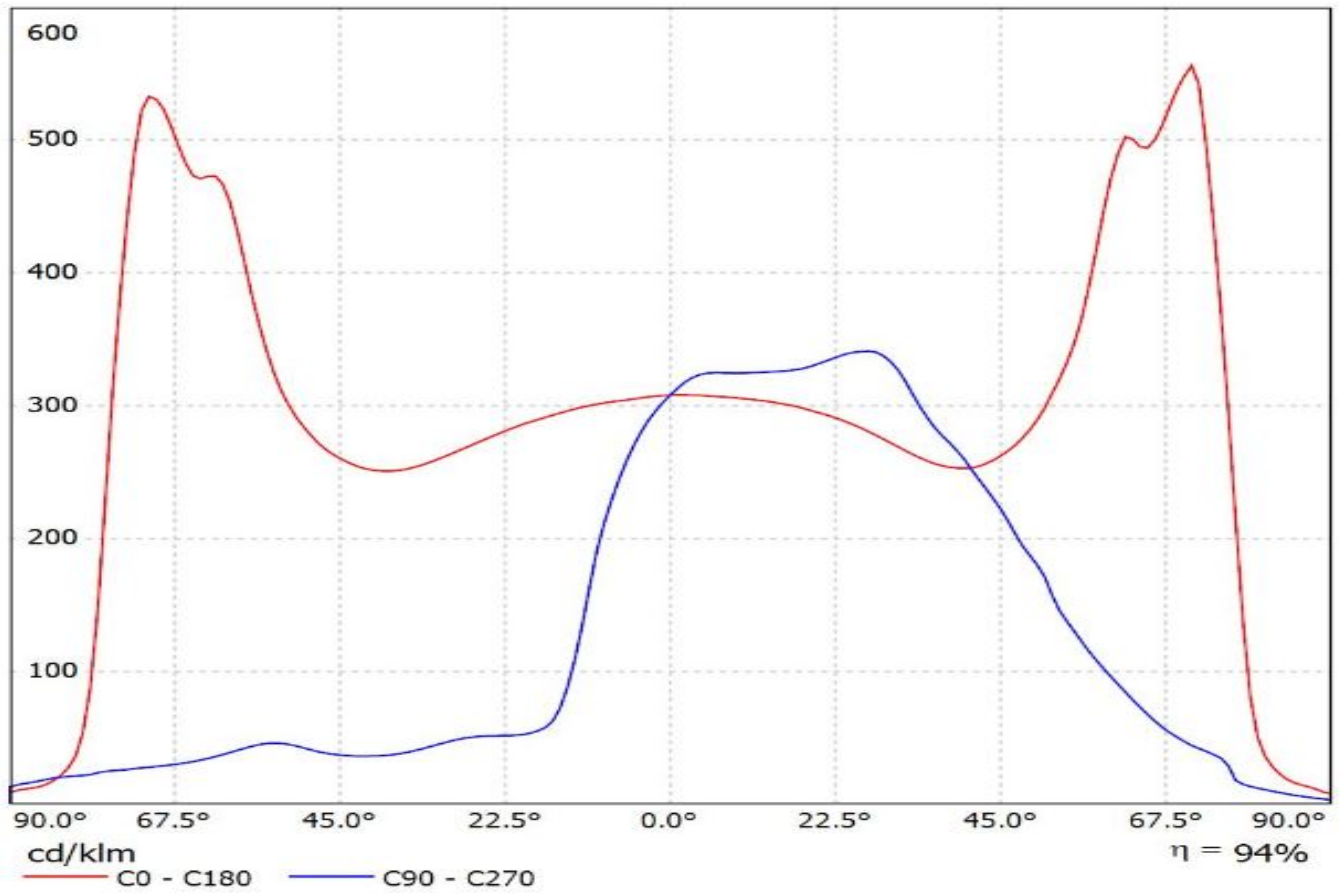

Luminaire: Ledil Oy C12362_STRADA-2X2-DWC-RE-ES Efficiency=93%
Lamps: 1 x Luxeon Rebel ES 250mA 366lm

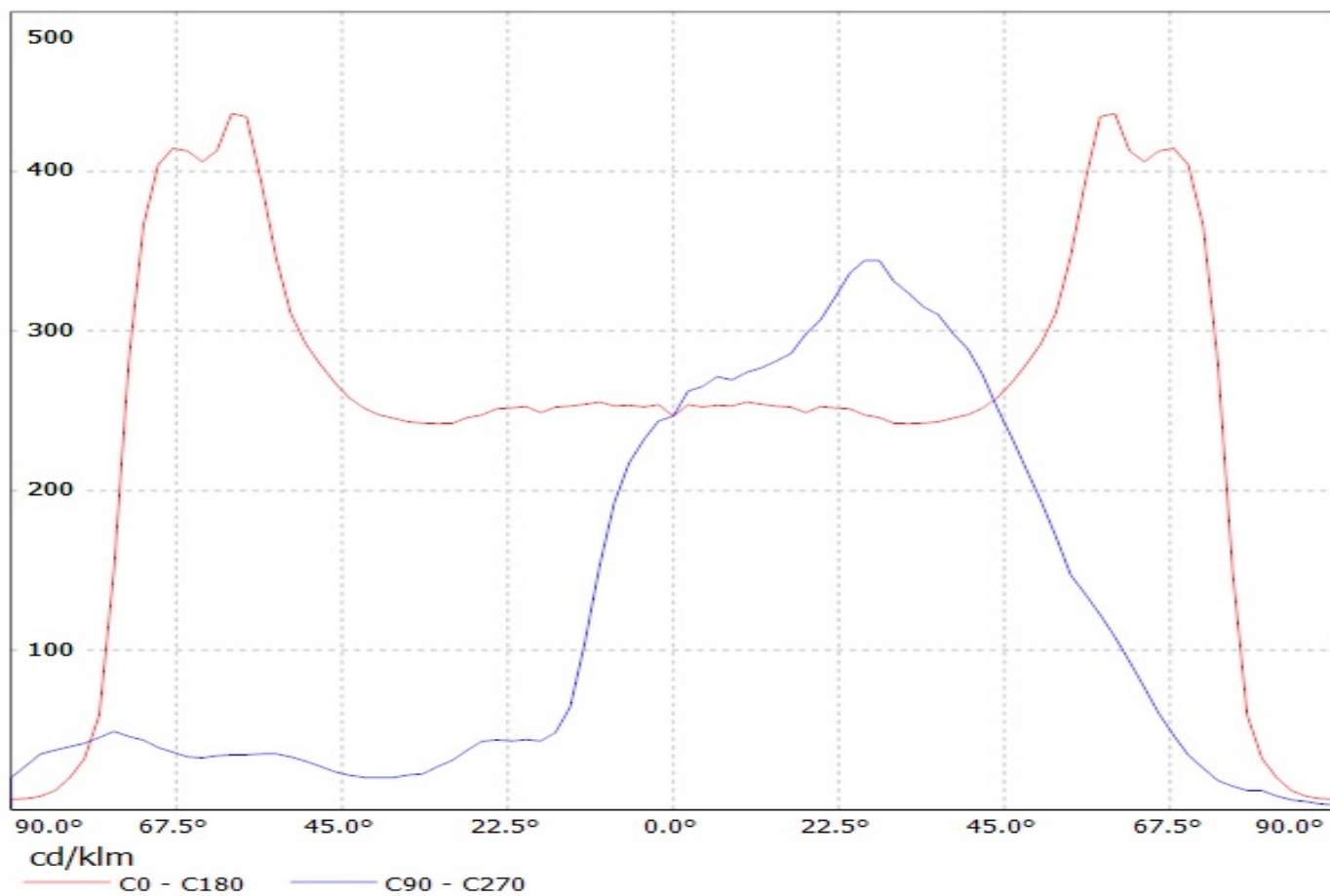

Luminaire: LEDiL Oy C12362_Strada-2x2-DWC_(LUXEON_T)_2 Eff.93.0%
Lamps: 1 x LUXEON_T 2x2 (294lm@250mA)

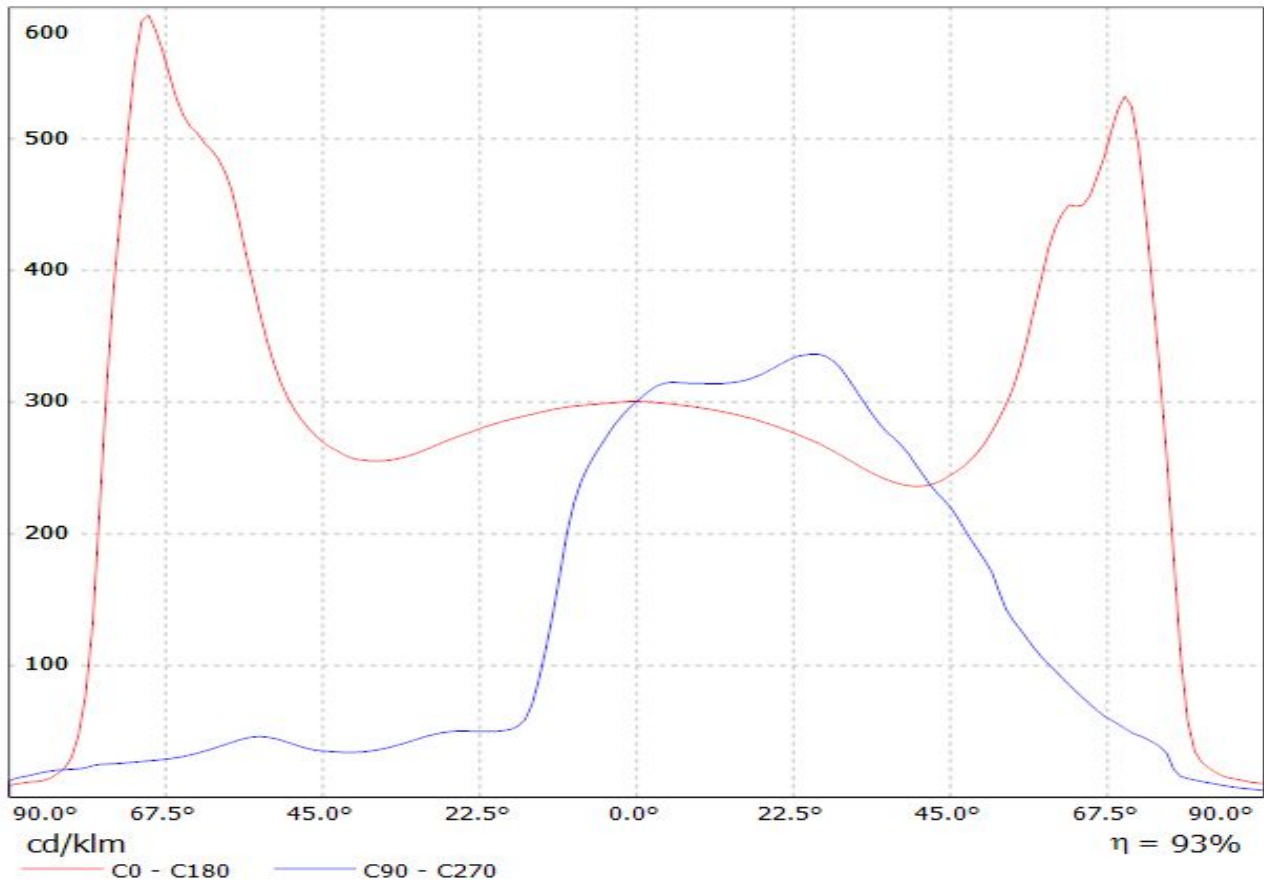

Luminaire: LEDiL Oy C12362_STRADA-2x2-DWC_(LUXEON_Q)
Lamps: 1 x LUXEON_Q_2x2_(LHQ-3080)_299.038lm@250mA_P=2.8742W_I=249.8mA

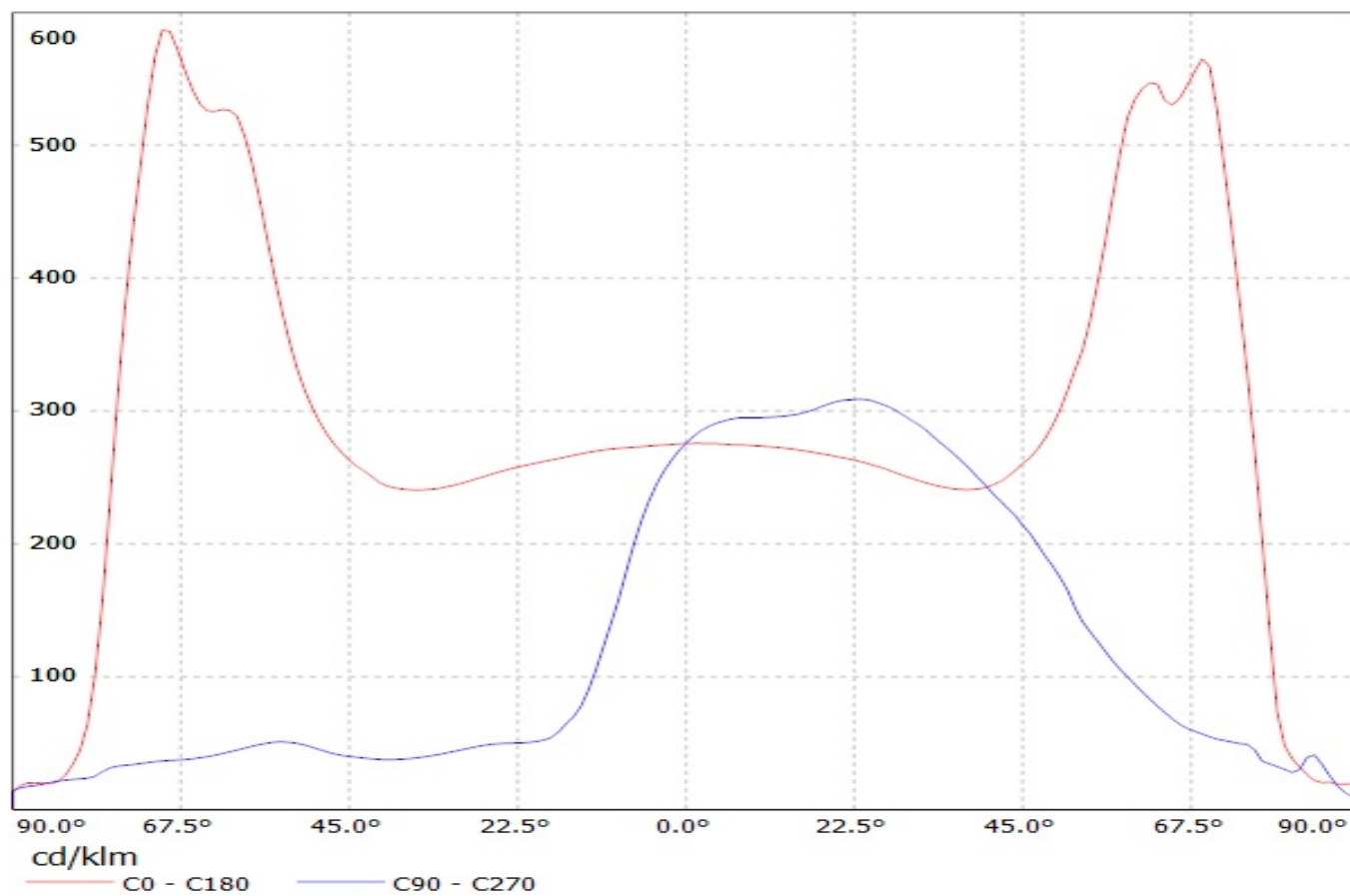

Luminaire: LEDiL Oy C12362_STRADA-2X2-DWC (Luxeon_TX)
Lamps: 1 x Luxeon_TX_2x2_321.384lm@250mA_P=2.79488W_I=249.9mA

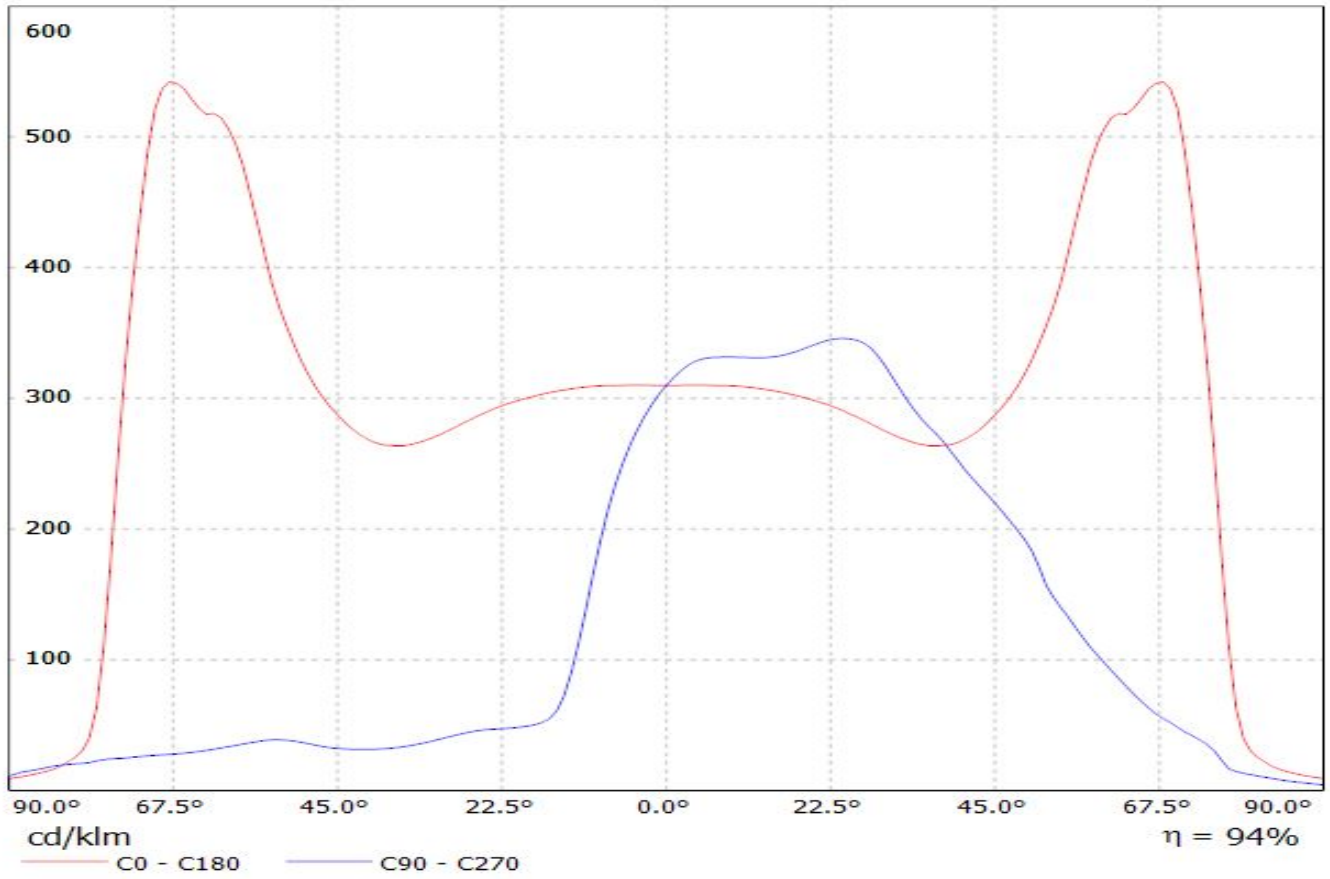

Luminaire: LEDiL Oy C12362_STRADA-2X2-DWC_(LUXEON_MZ) Eff.94.0%
Lamps: 1 x LUXEON_MZ_2x2_(LMZ7-QW57)_415lm@250mA_P=2.71916W_CCT=5700K_I=249.9mA

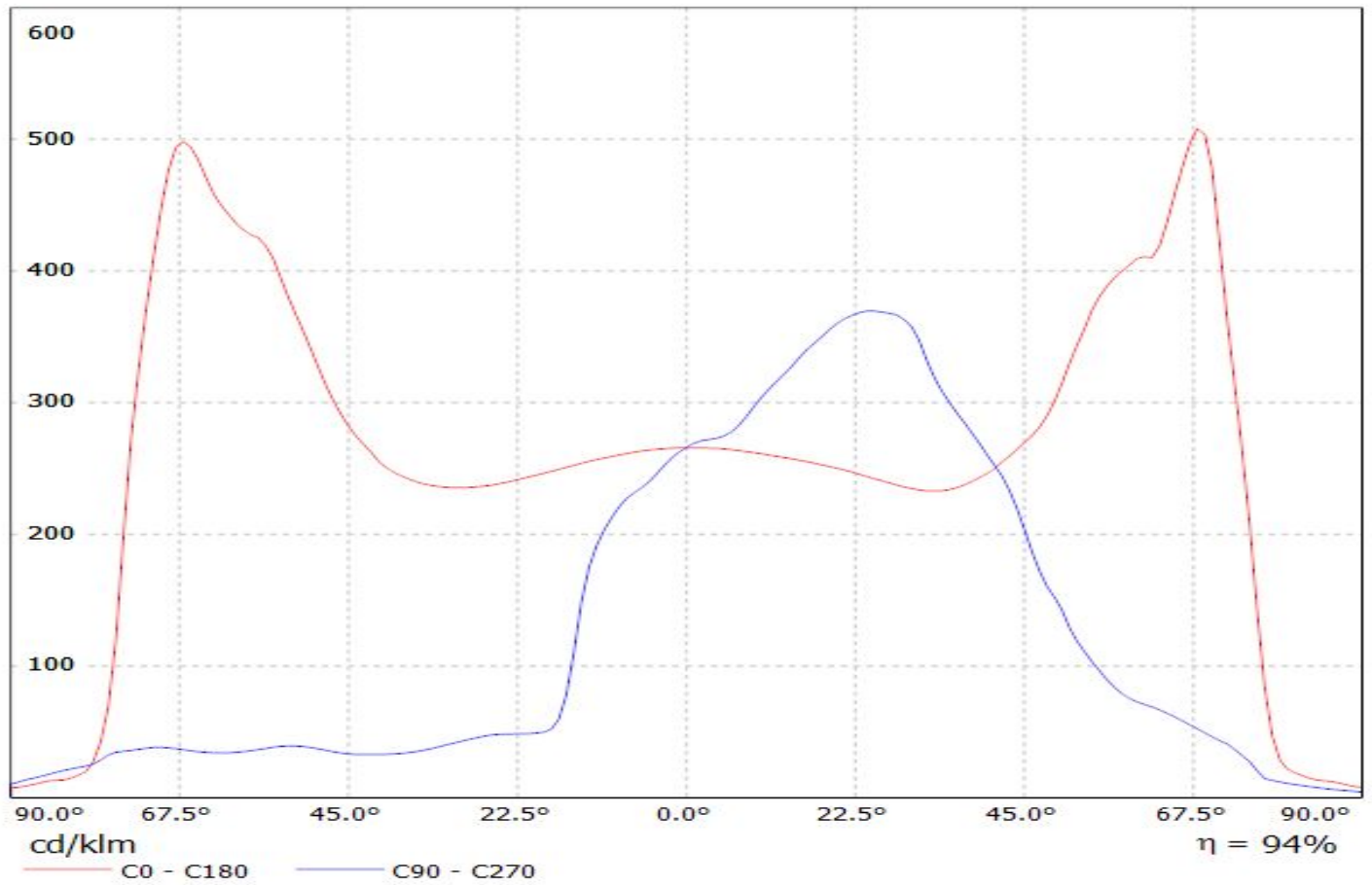

Luminaire: LEDiL Oy C12362_STRADA-2X2-DWC (Luxeon_5050)

Lamps: 1 x Luxeon_5050_2x2_1270.76lm@80mA_CCT=5700K_P=7.35815W_I=0.080A_70CRI

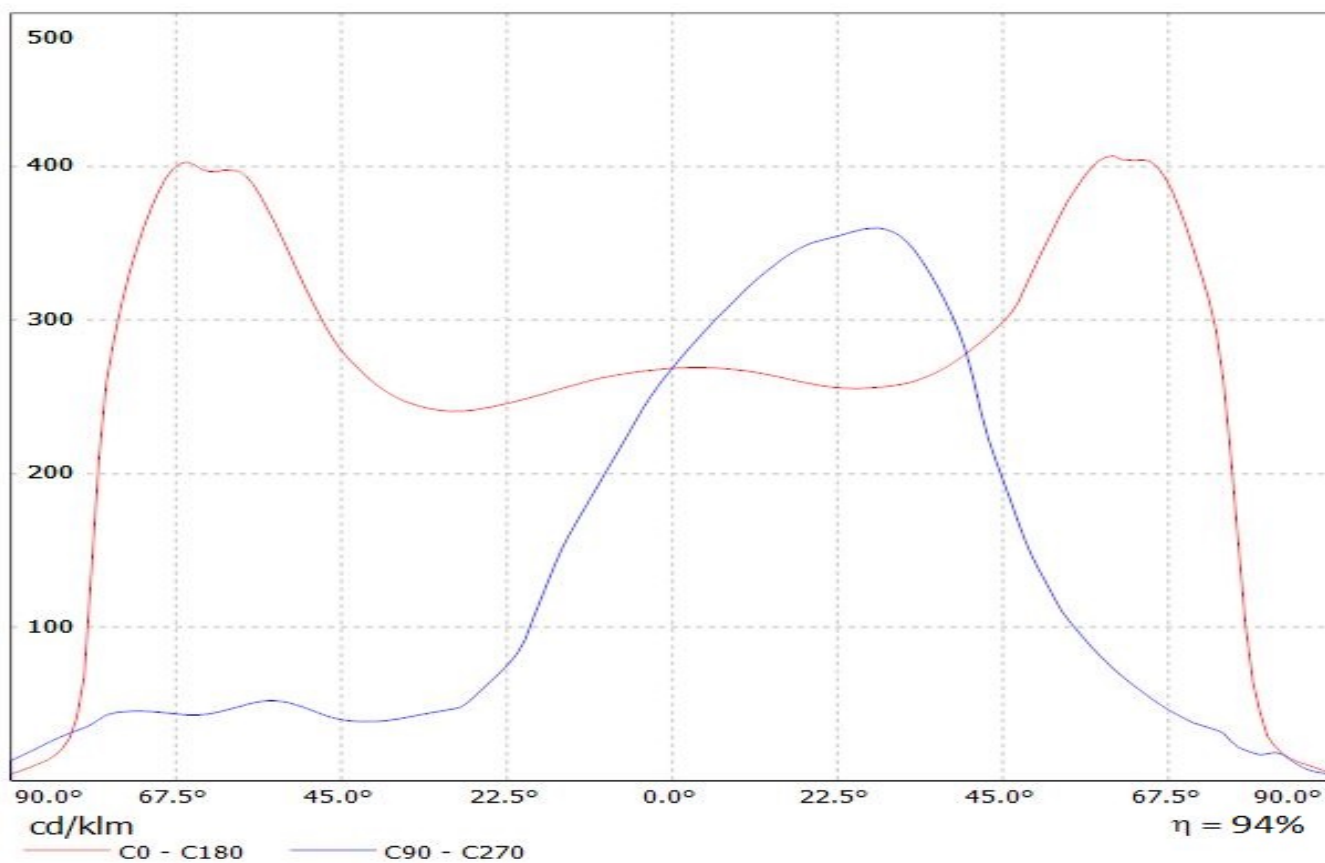

**LEDiL Oy C12362_STRADA-2x2-DWC_(NICHIA_NS9x383) Eff.95.1% / LDC
(Linear)**

Luminaire: LEDiL Oy C12362_STRADA-2x2-DWC_(NICHIA_NS9x383) Eff.95.1%
Lamps: 1 x NICHIA_NS9x383 (287.074lm@250mA)

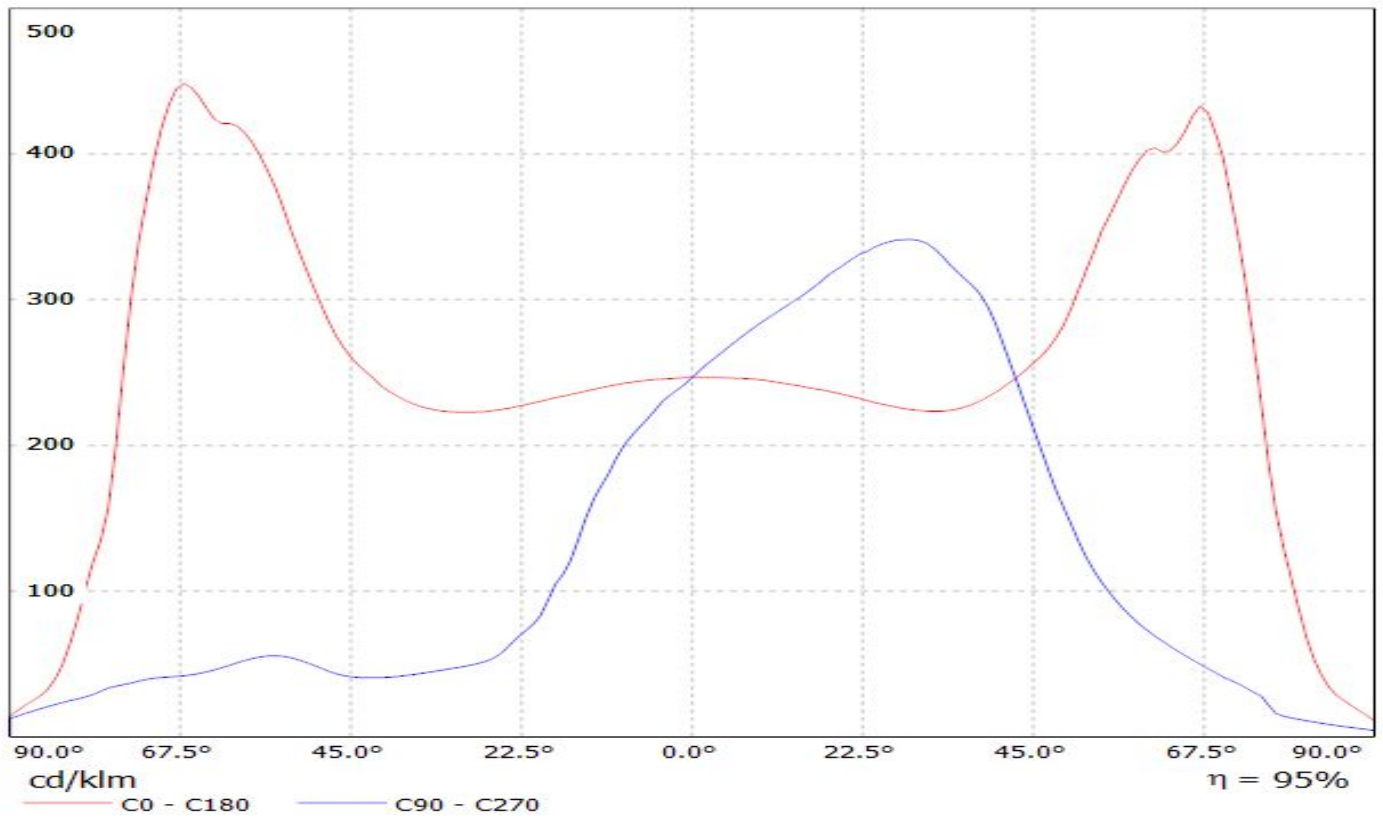

Ledil C12362_STRADA-2X2-DWC_(NVSL219BE) / LDC (Linear)

Luminaire: Ledil C12362_STRADA-2X2-DWC_(NVSL219BE)

Lamps: 1 x Nichia_NVSL219BE_319.707lm@250mA_CCT=3071K_P=2.8910W_I=0.25A

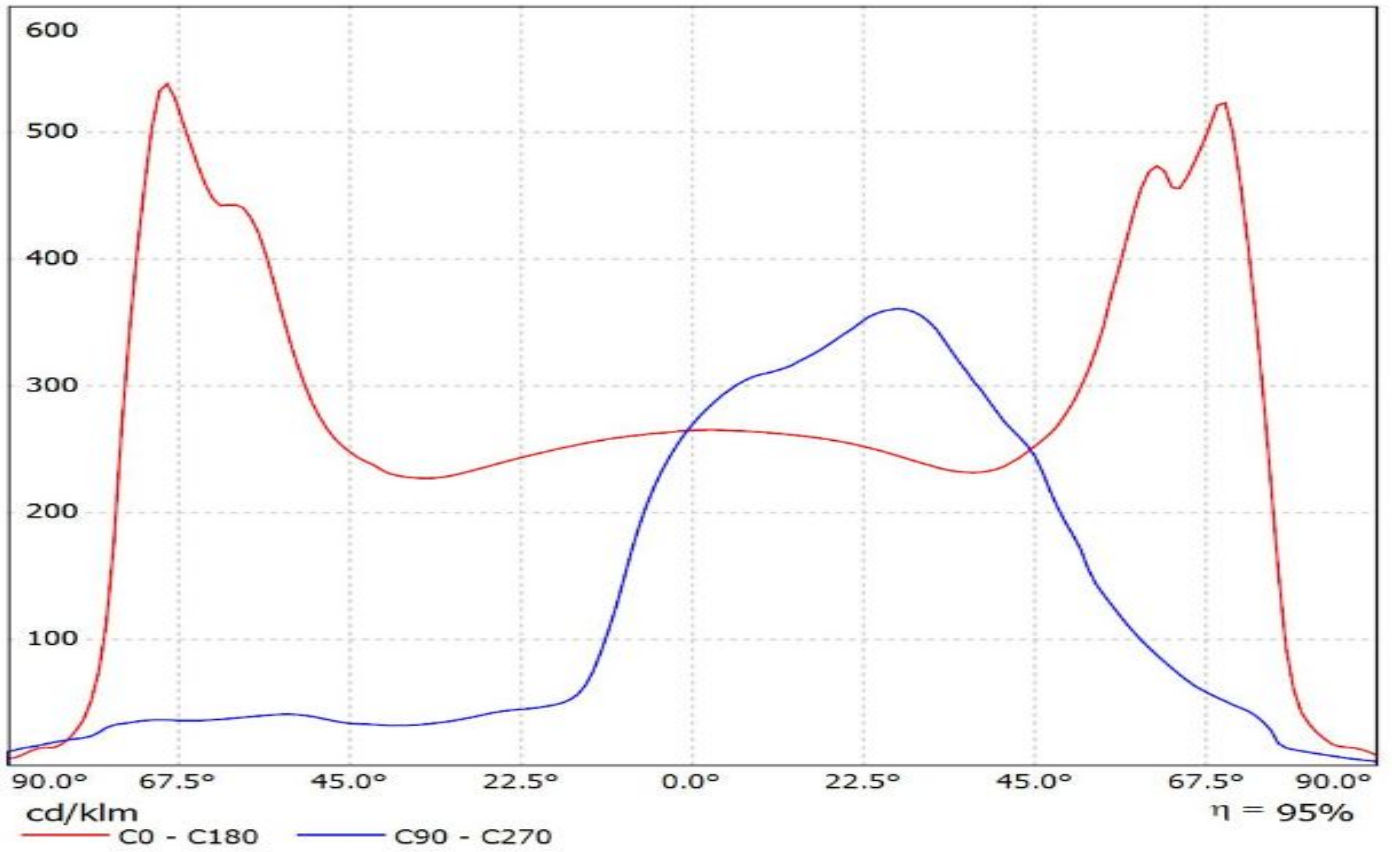

Luminaire: LEDiL Oy C12362_STRADA-2X2-DWC_(NWSL229AE)_GS
Lamps: 1 x Nichia_NWSL229AE_476.846lm@250mA_P=2.75804W_I=0.250A

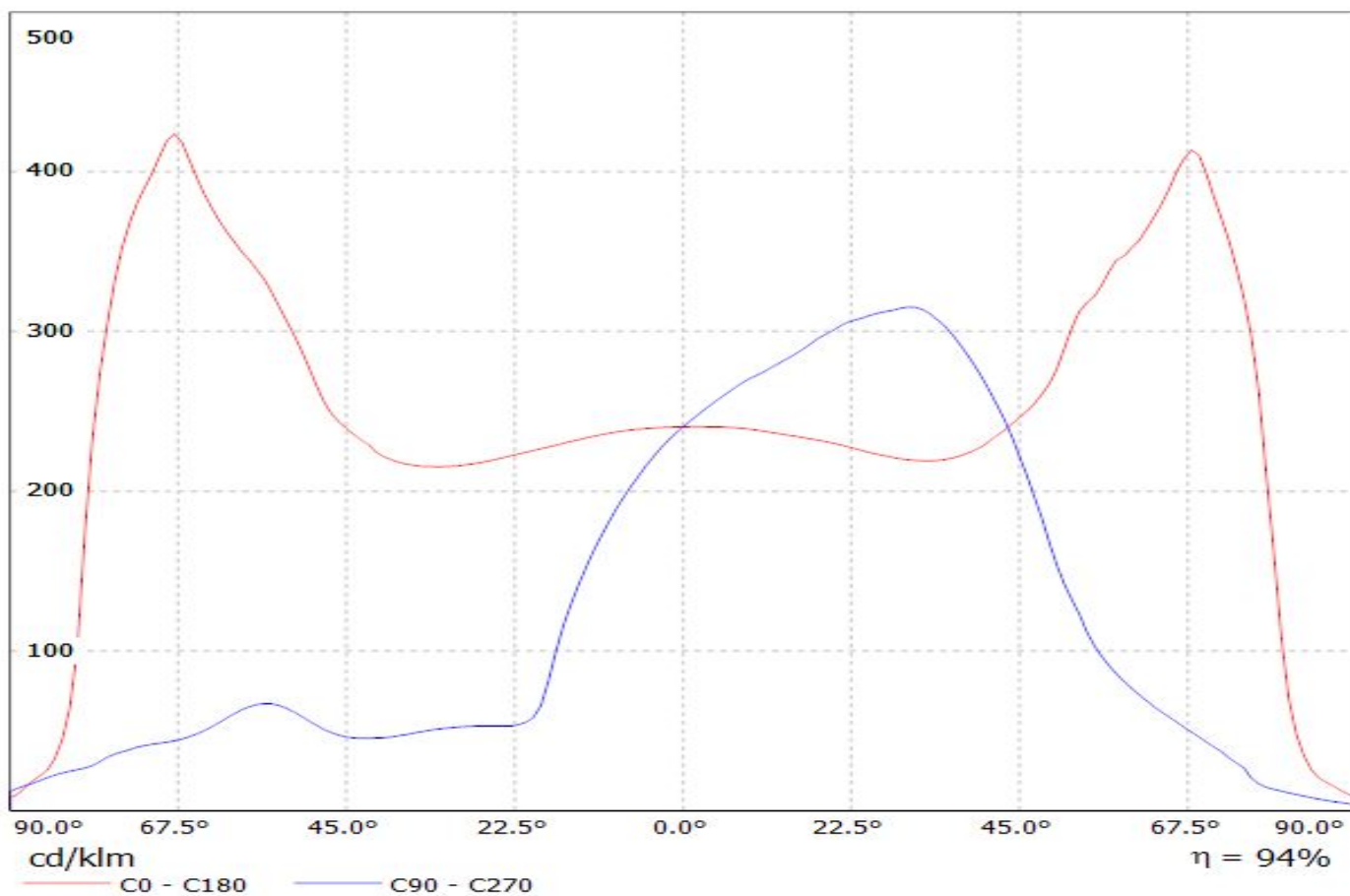

Luminaire: Ledil C12362_STRADA-2X2-DWC_(NVSW319AE)

Lamps: 1 x Nichia_NVSW319AE_(sm405D440f2L2R70)_516.263lm@250mA_P=2.82725W_I=0.250A

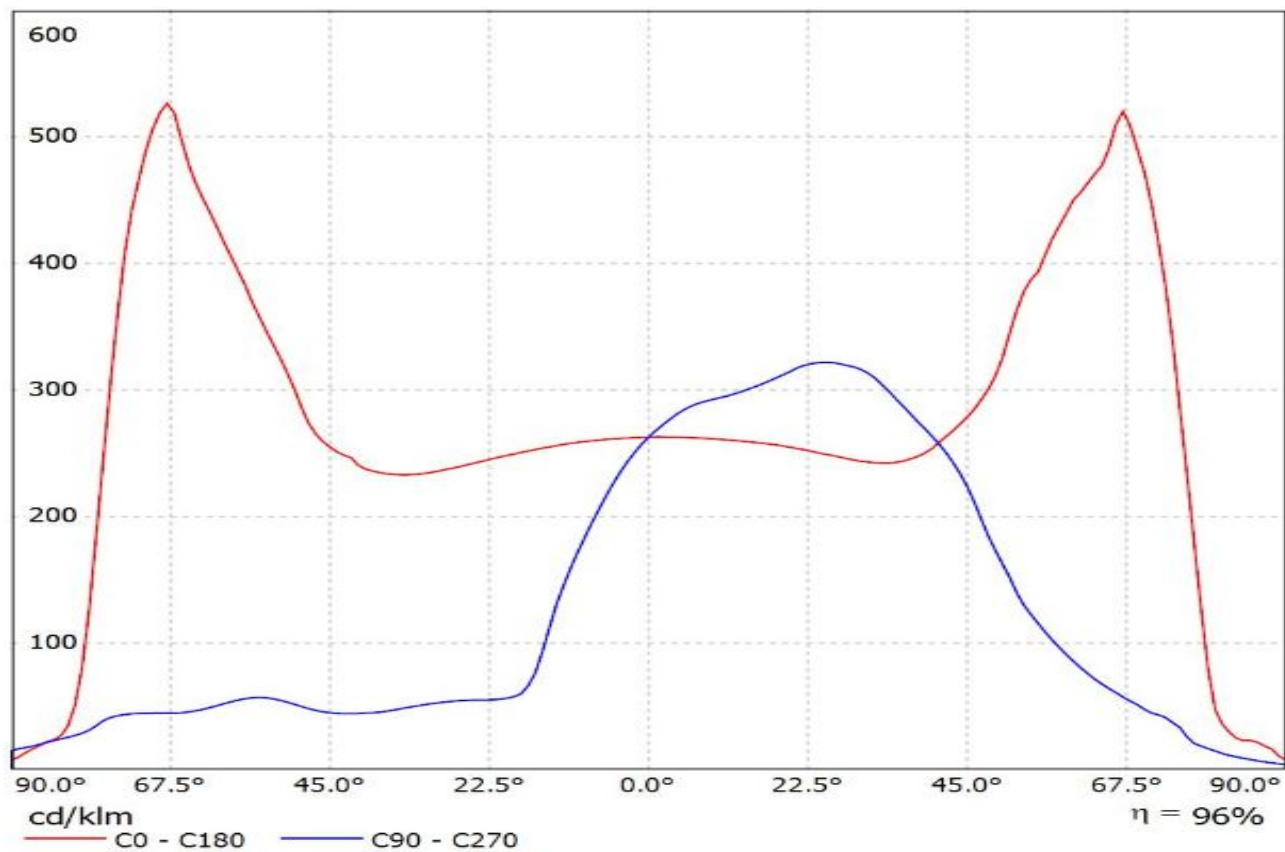

Luminaire: LEDiL Oy C12362_STRADA-2X2-DWC_(E21A)
Lamps: 1 x Nichia_E21A_2x2_451.527lm@250mA_P=2.8055W_I=0.250A

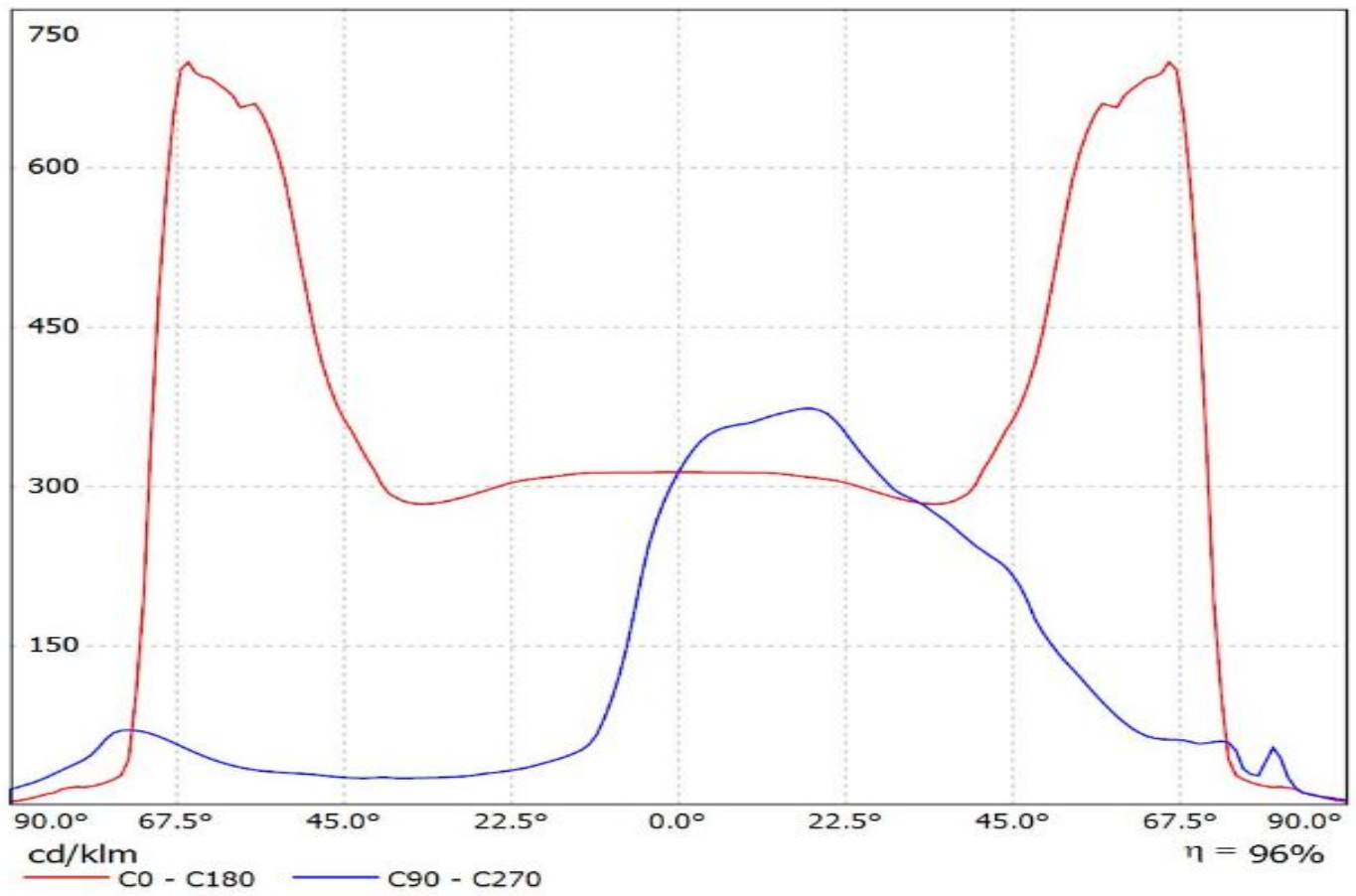

Luminaire: Ledil Oy C12362_STRADA-2X2-DWC (Osram Square PC 398lm @ 250mA) Efficiency=92%
Lamps: 1 x Osram Square PC 398lm @ 250mA

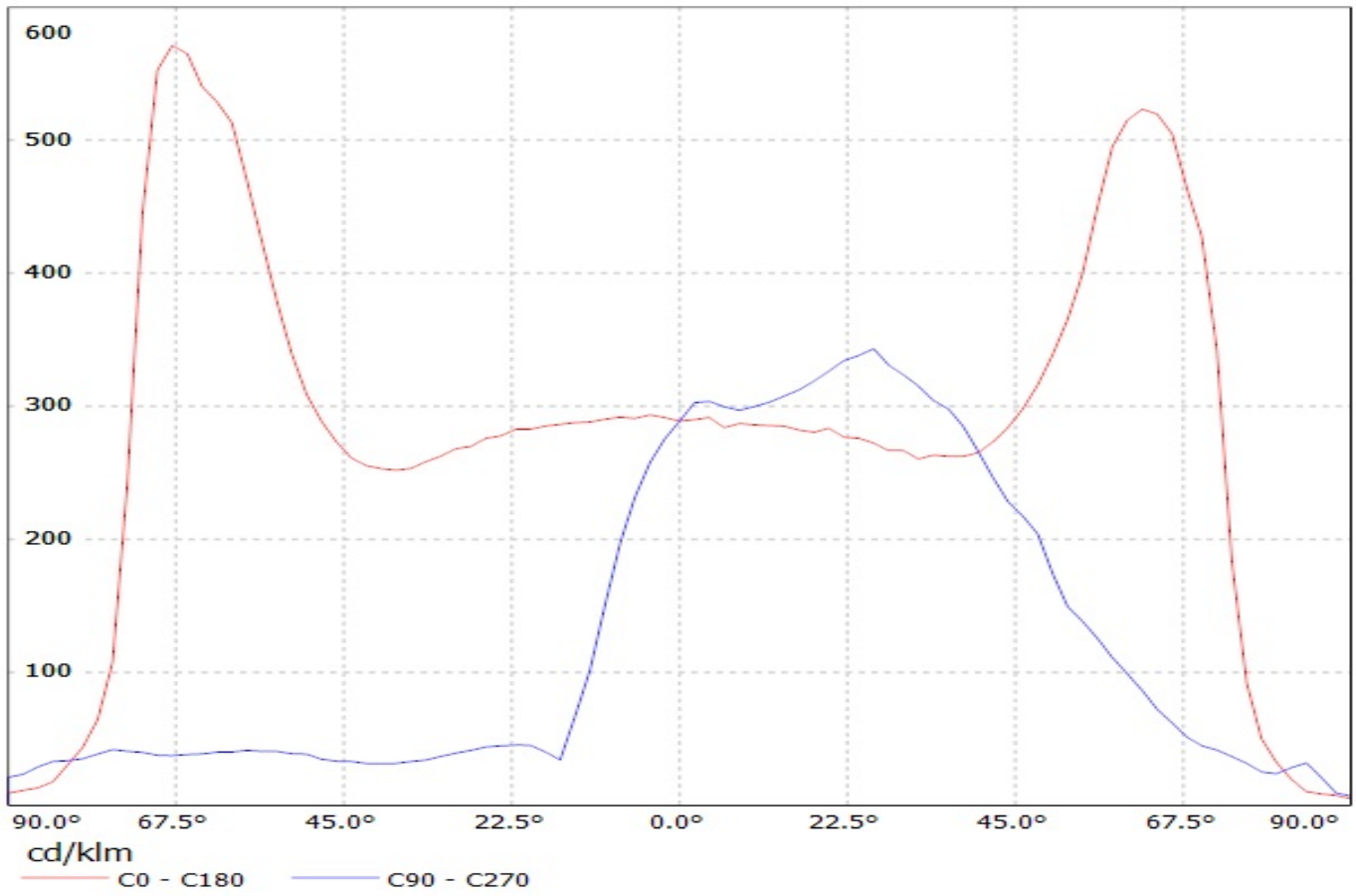

Luminaire: LEDiL Oy C12362_STRADA-2X2-DWC_(Square_Gen3)

Lamps: 1 x Osram_Square_Gen3_GW_CSSRM2.PM_450.897lm@250mA_P=2.788_I=250mA

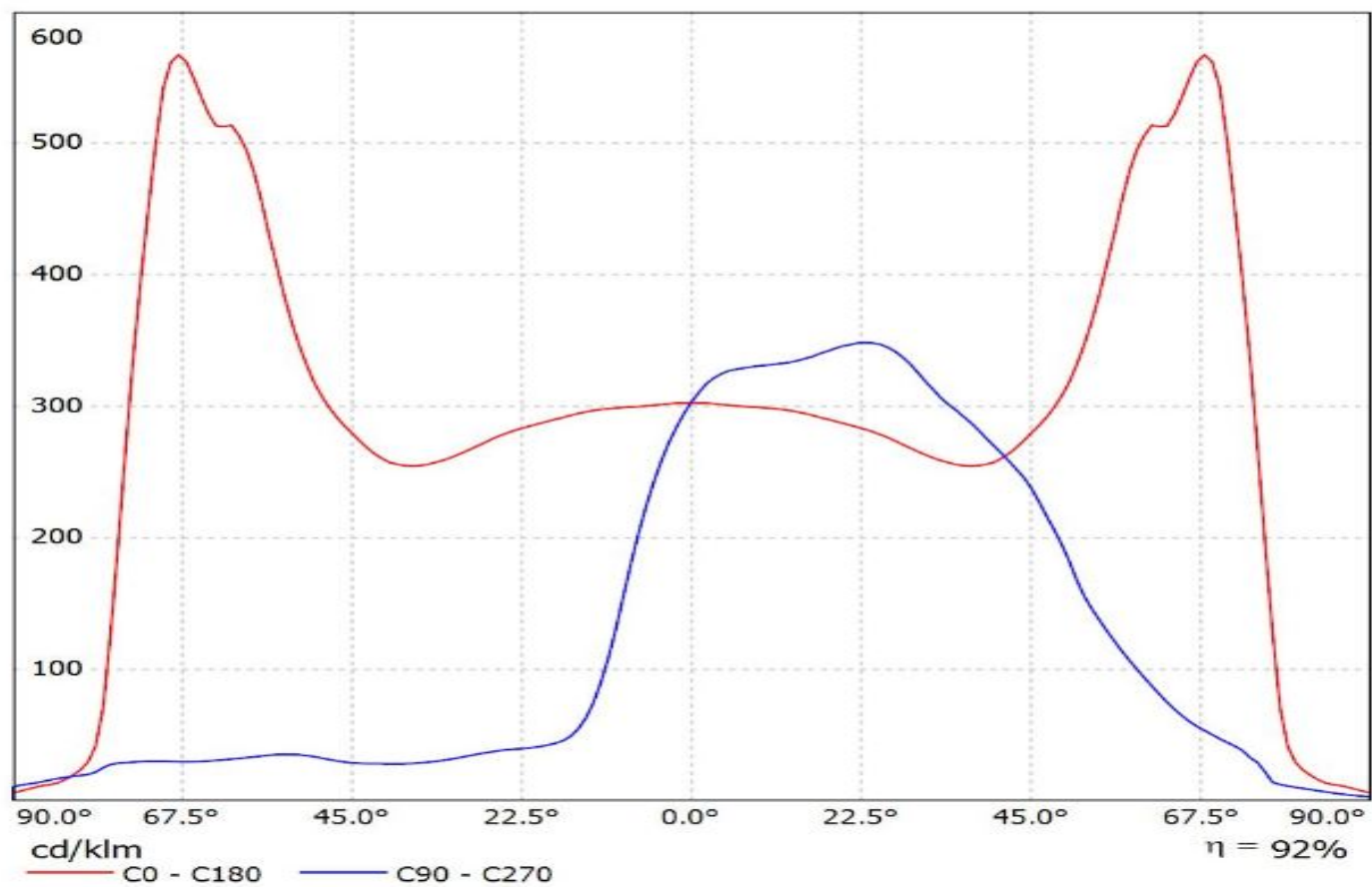

Luminaire: Ledil Oy C12362_STRADA-2X2-DWC_(Duris_P8)_SIMULATED
Lamps: 1 x Osram Duris P8

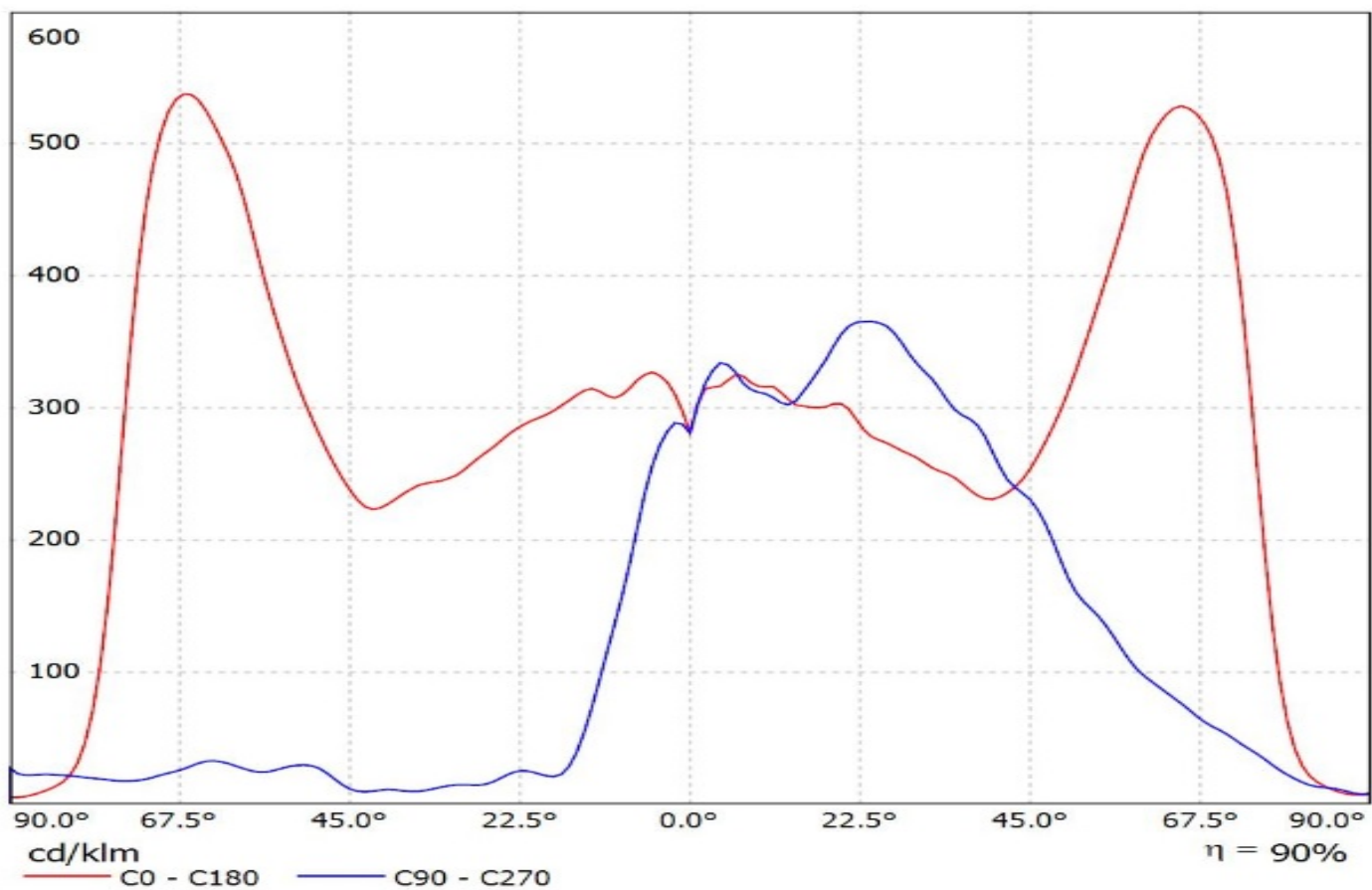

Luminaire: LEDiL Oy C12362_STRADA-2X2-DWC_(Fortimo_F-Flex_2x8_740DAG3)

Lamps: 1 x Philips_Fortimo_FastFlex_LED_board_2x8/740_DA_G3_1795.7lm@250mA_P=11.6015W_I=0.2498A

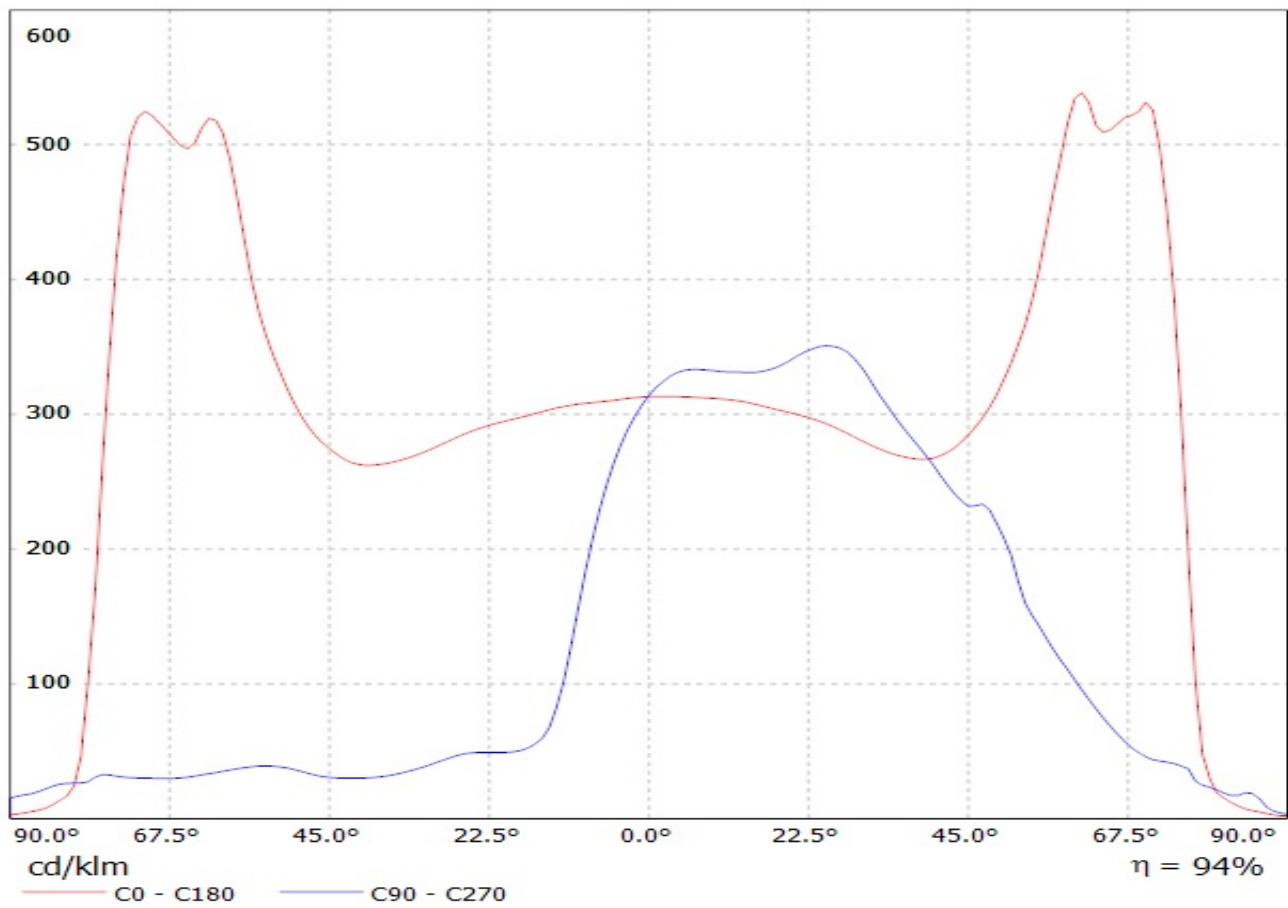

Luminaire: LEDiL Oy C12362_STRADA-2X2-DWC_(LH351B) Eff.89.3%
Lamps: 1 x SAMSUNG_LH351B_2x2_430.715lm@250mA_P=2.84311W_I=249.9mA

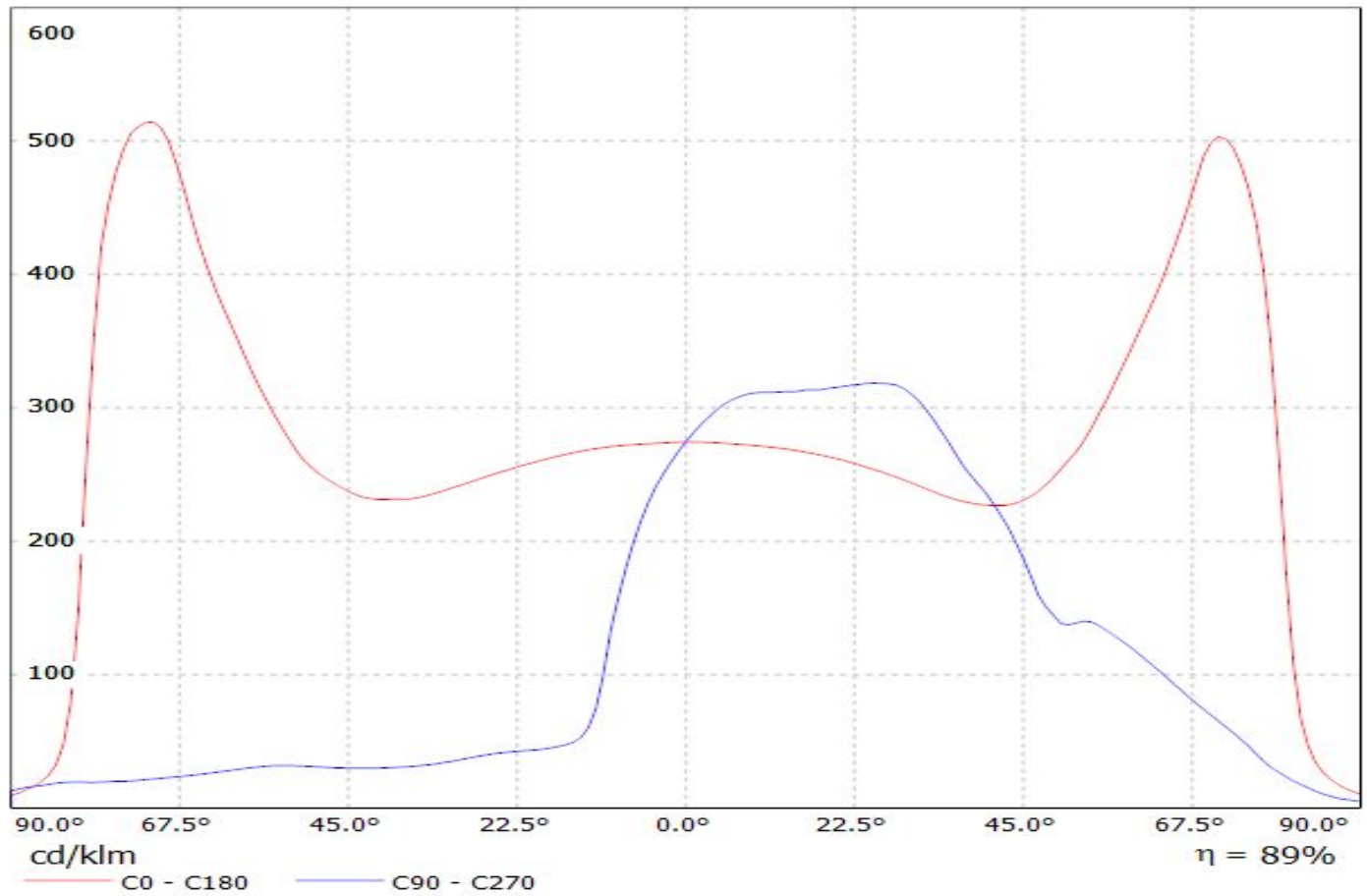

Luminaire: LEDiL Oy C12362_STRADA-2X2-DWC_(LH351Z)
Lamps: 1 x SAMSUNG_LH351Z_2x2_360.93lm@250mA_P=2.86596W_I=249.8mA

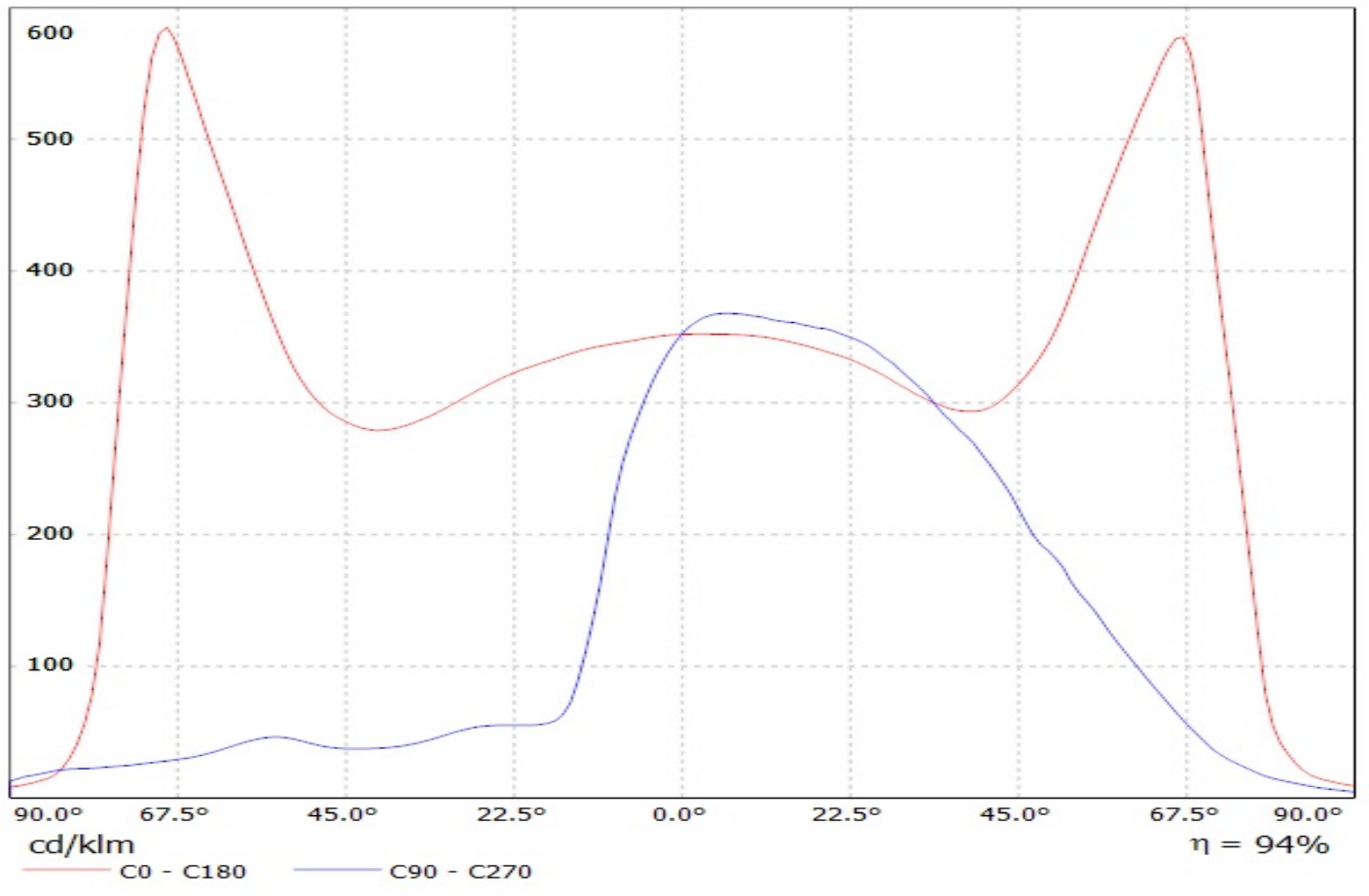

Luminaire: Ledil C12362_STRADA-2X2-DWC_(LH351D)
Lamps: 1 x Samsung_LH351D_536.957lm@250mA_P=2.7695W_I=0.250A

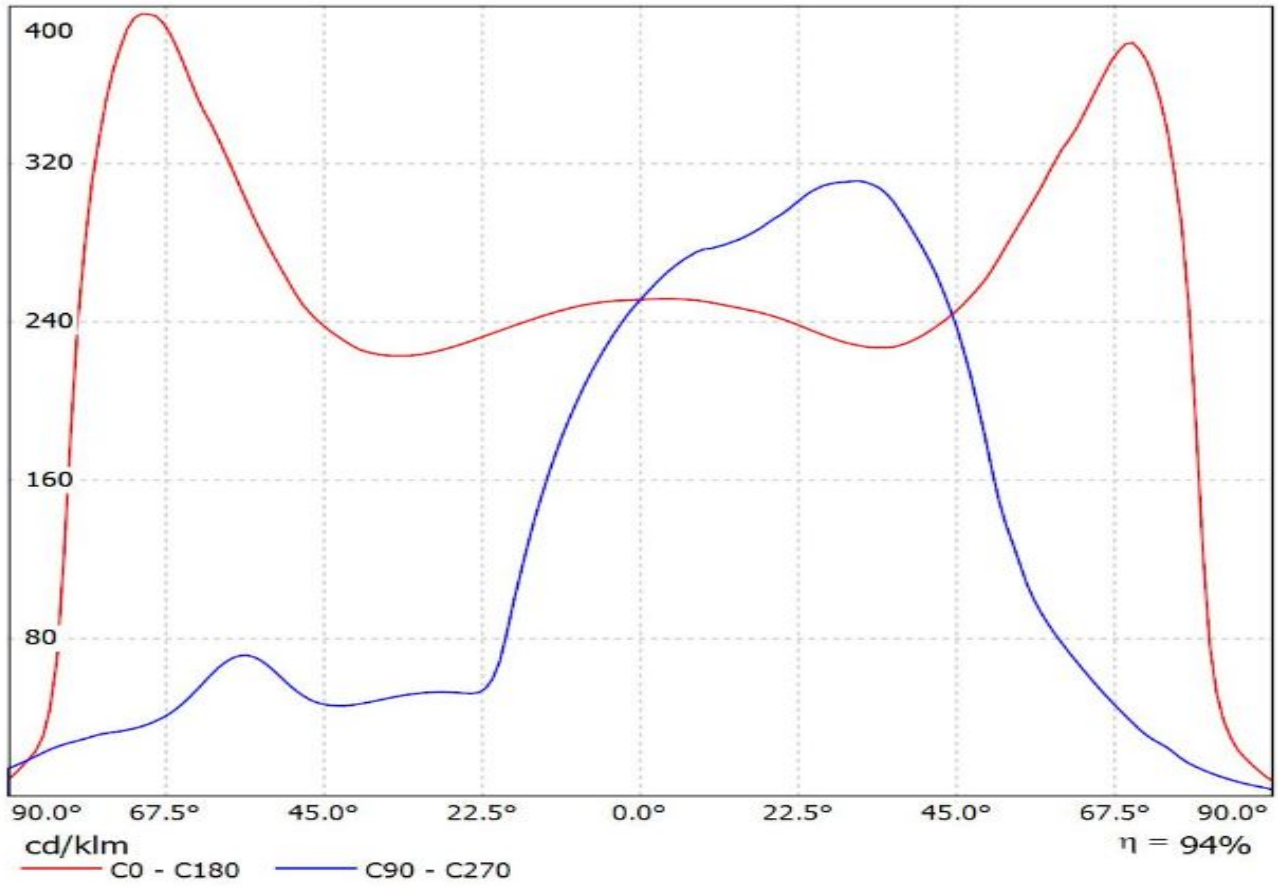

LEDiL Oy C12362_STRADA-2x2-DWC_(MJT4040) Eff.94.0% / LDC (Linear)

Luminaire: LEDiL Oy C12362_STRADA-2x2-DWC_(MJT4040) Eff.94.0%
Lamps: 1 x SEOUL ACHRICH MJT4040 (SAW09H0A) 255.63lm@40mA P=2.37W I=40mA

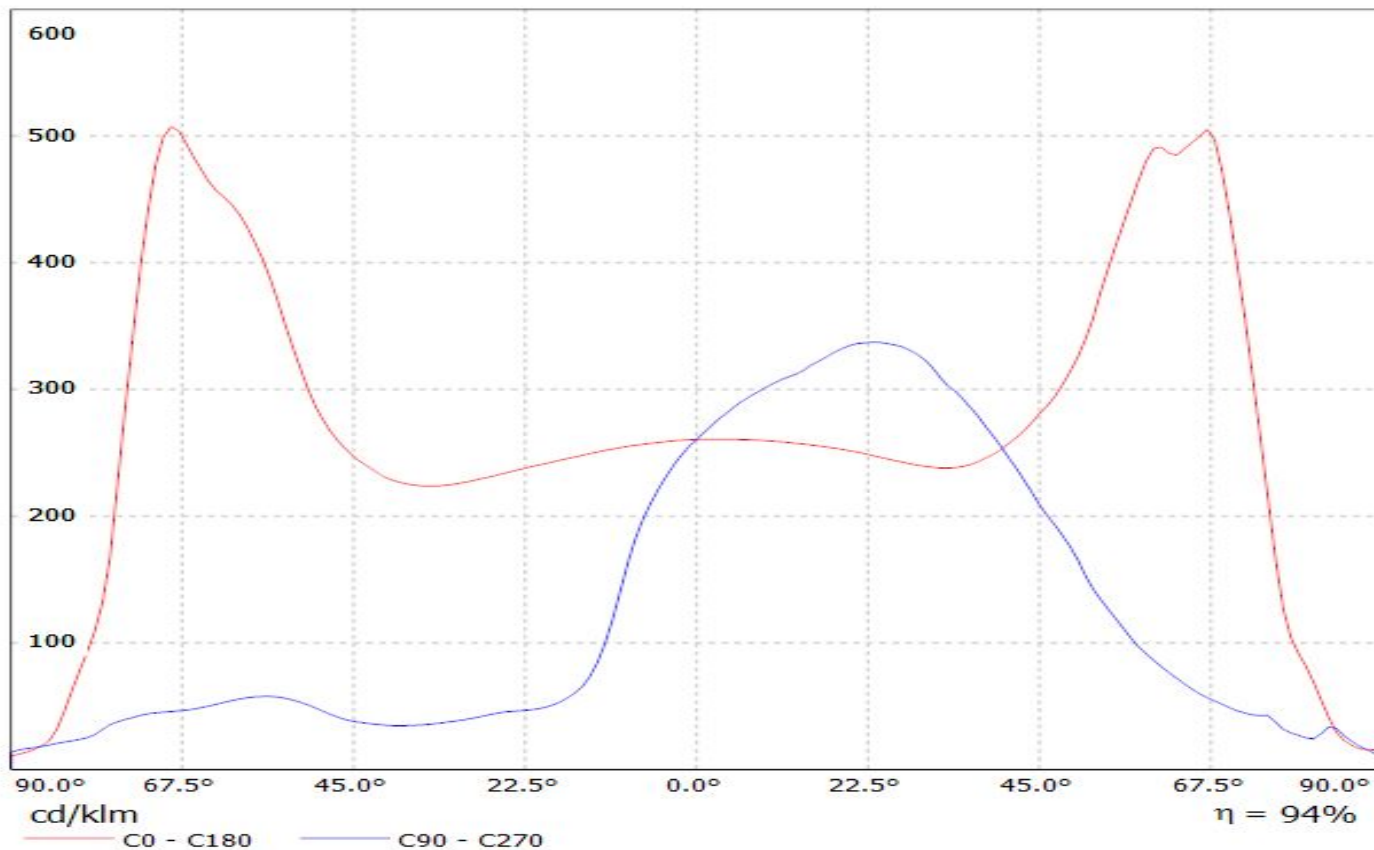

Luminaire: LEDil Oy C12362_STRADA-2X2-DWC_(Z5M1) Efficiency=94%
Lamps: 1 x Seoul Z5M1 (SZ5-M1-WN-C8) 379lm @ 250mA CCT=4600K P=2.9W I=250mA

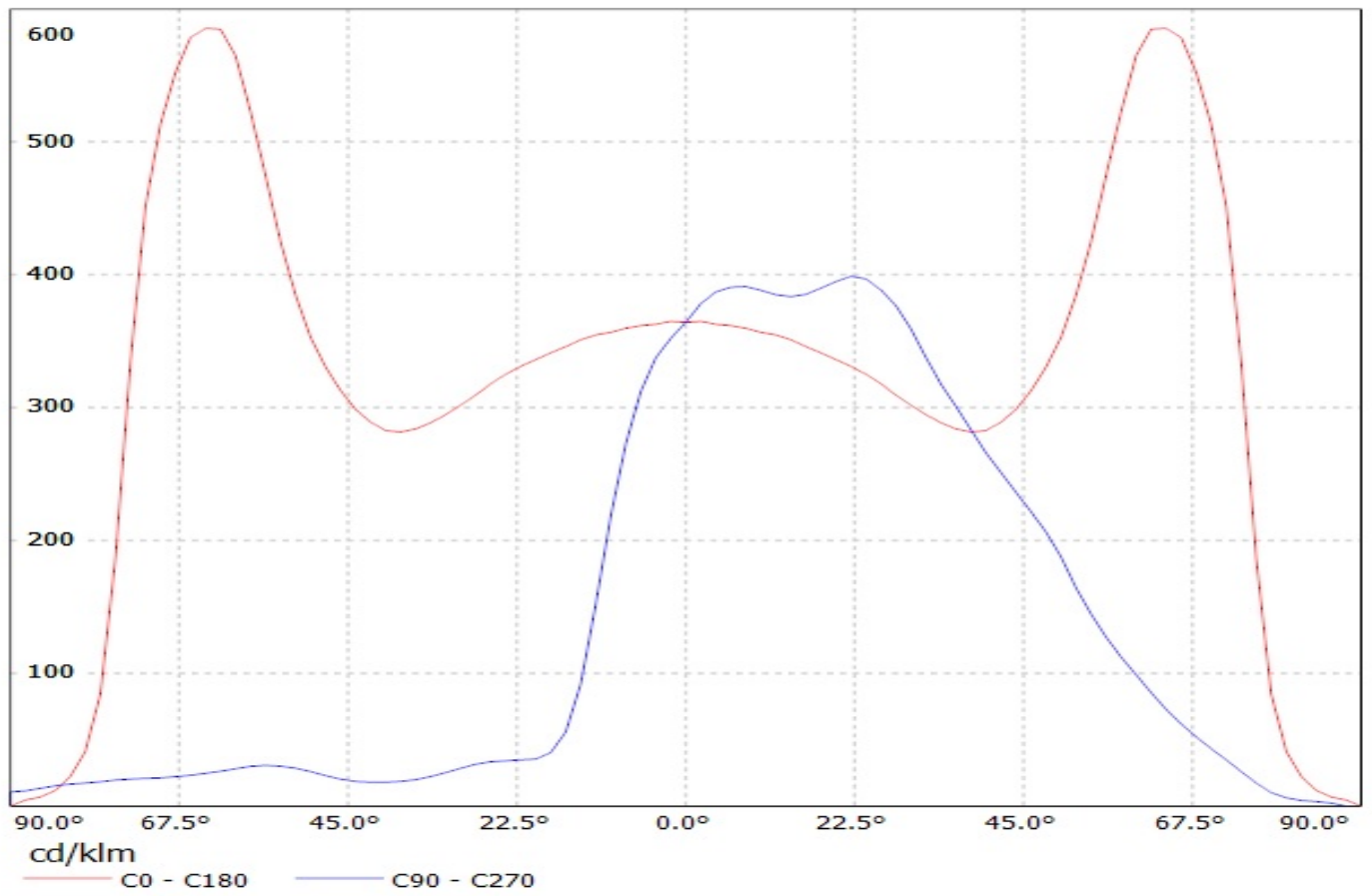

Luminaire: Ledil C12362_STRADA-2X2-DWC_(Z8Y22plus)

Lamps: 1 x Seoul_Z8Y22plus_(W6E2G)_513.996lm@250mA_P=2.754W_I=0.250A

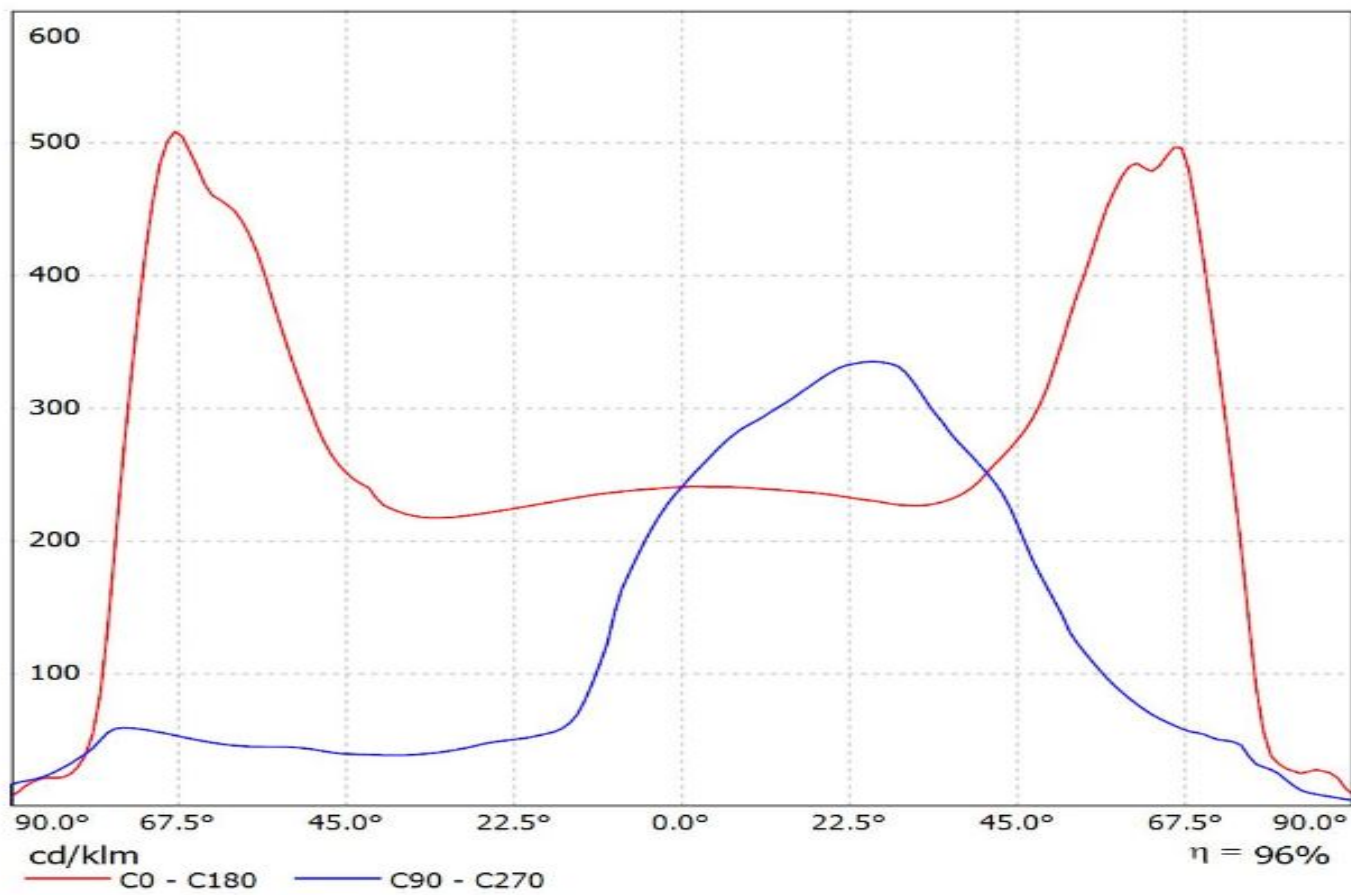

Ledil C12362_STRADA-2X2-DWC_(TL1L4) / LDC (Linear)

Luminaire: Ledil C12362_STRADA-2X2-DWC_(TL1L4)

Lamps: 1 x Toshiba_TL1L4_2x2_(TL1L4-DW0)_472.639lm@250mA_CCT=6500K_P=2.9W_I=0.25A

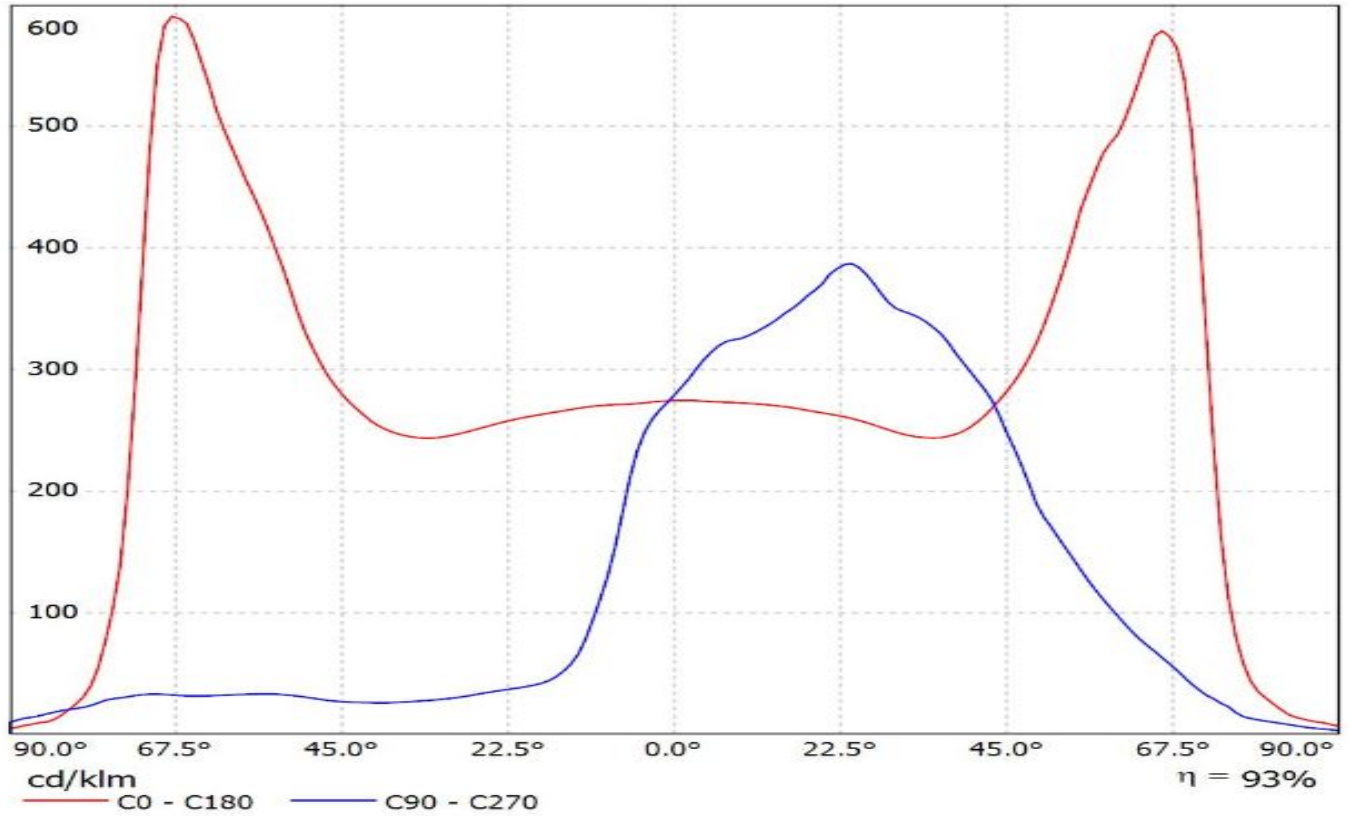

Luminaire: LEDiL Oy C12362_STRADA-2X2-DWC_(Tridonic_Module_RLE_G1)
Lamps: 1 x Tridonic_Module_RLE_G1_4576.03lm@700mA_P=32.0681W_I=0.700A

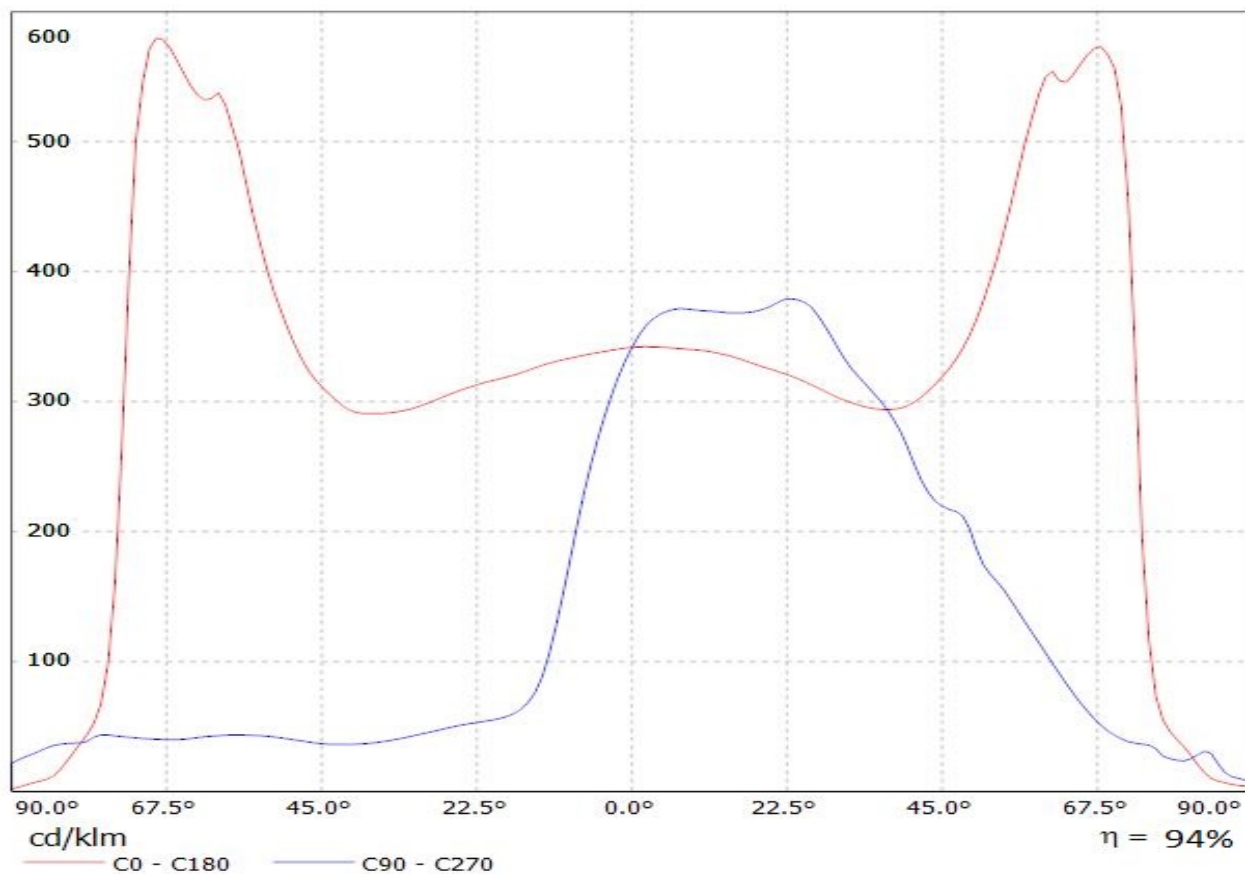

Luminaire: LEDiL Oy C12362_STRADA-2X2-DWC_(Tridonic_Module_RLE_G1)
Lamps: 1 x Tridonic_Module_RLE_G1_4576.03lm@700mA_P=32.0681W_I=0.700A

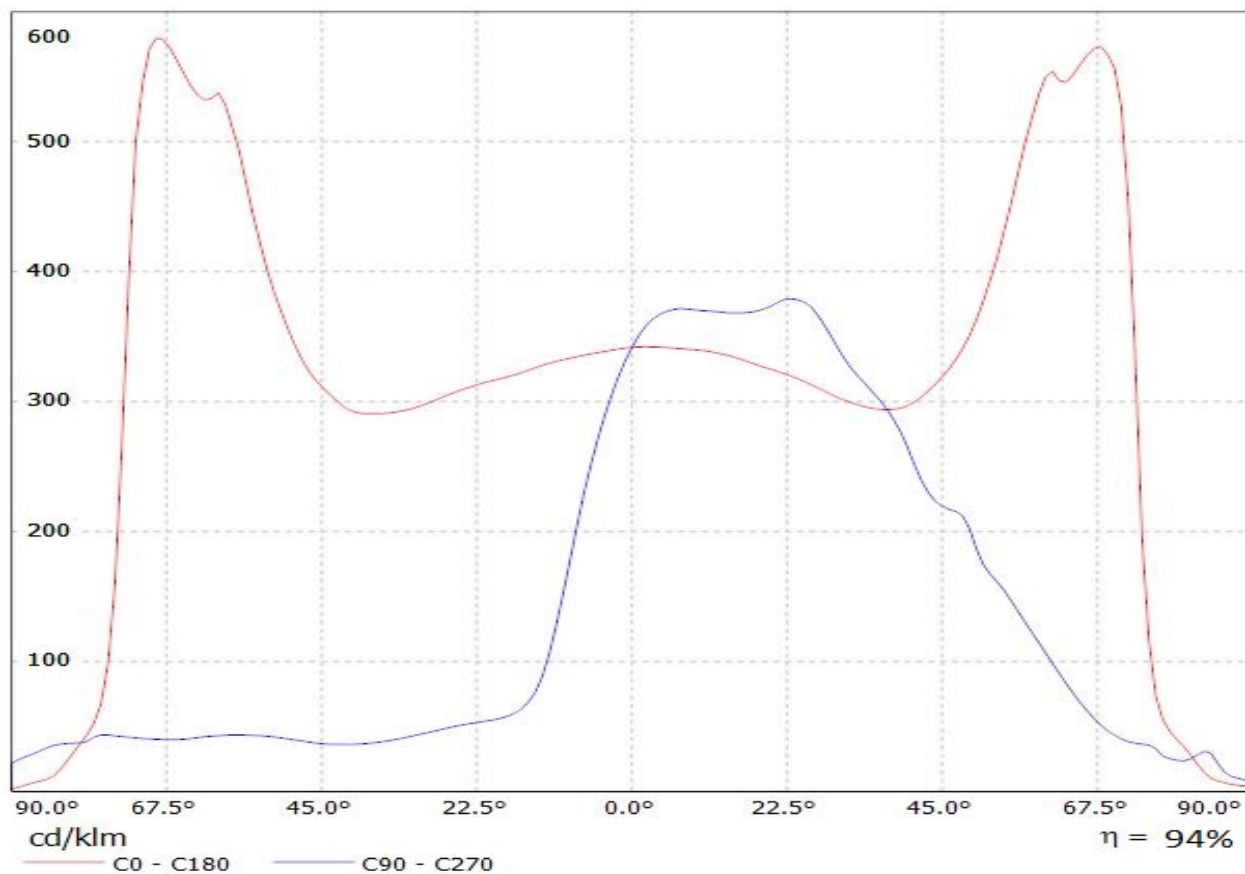

Luminaire: LEDiL Oy C12362_STRADA-2X2-DWC_(Tridonic_Module_RLE_G1)
Lamps: 1 x Tridonic_Module_RLE_G1_2288lm@700mA_P=16W_I=0.700A

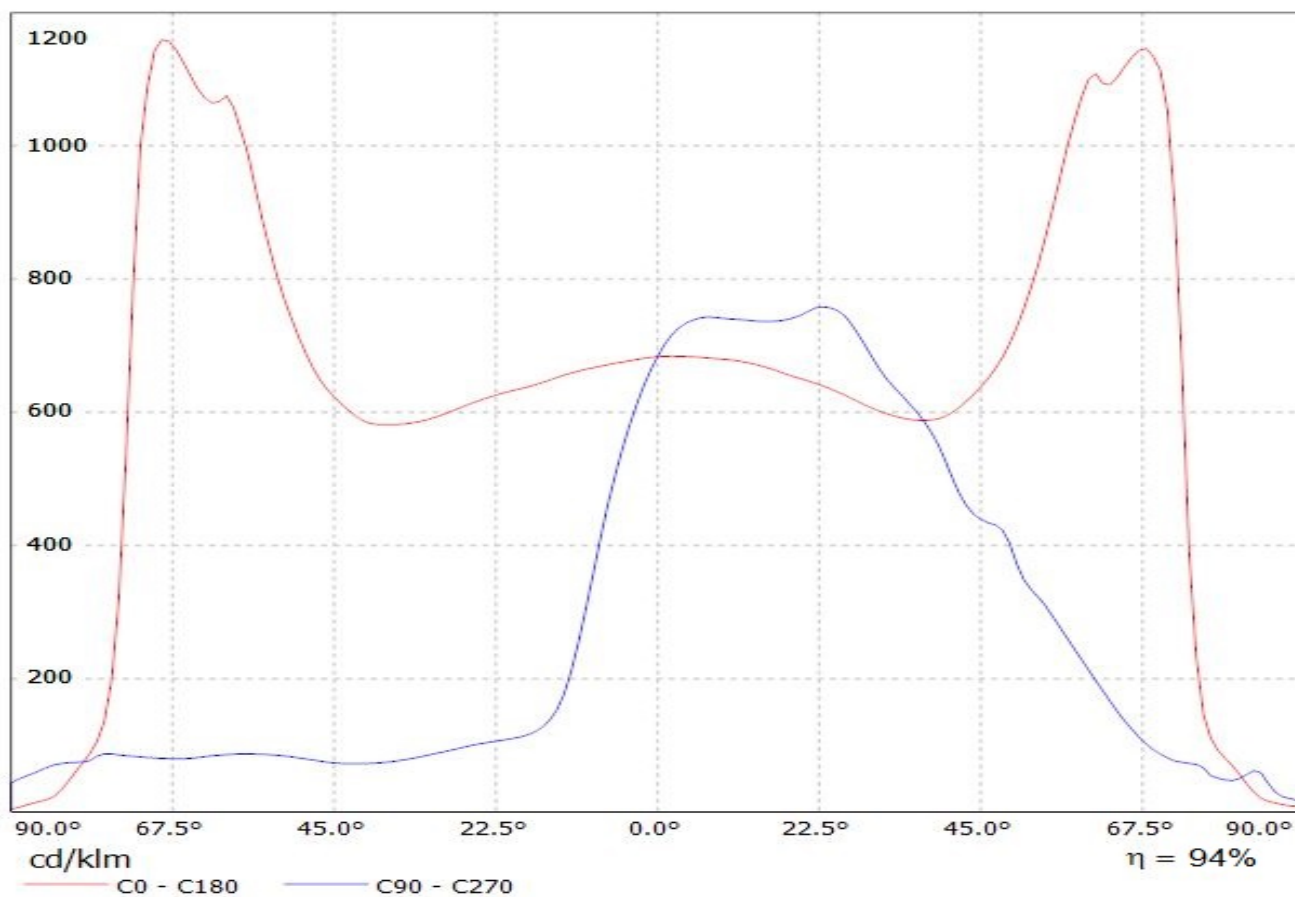

Luminaire: LEDiL Oy C12362_STRADA-2X2-DWC_(Tridonic_Module_RLE_G1)
Lamps: 1 x Tridonic_Module_RLE_G1_2288lm@700mA_P=16W_I=0.700A

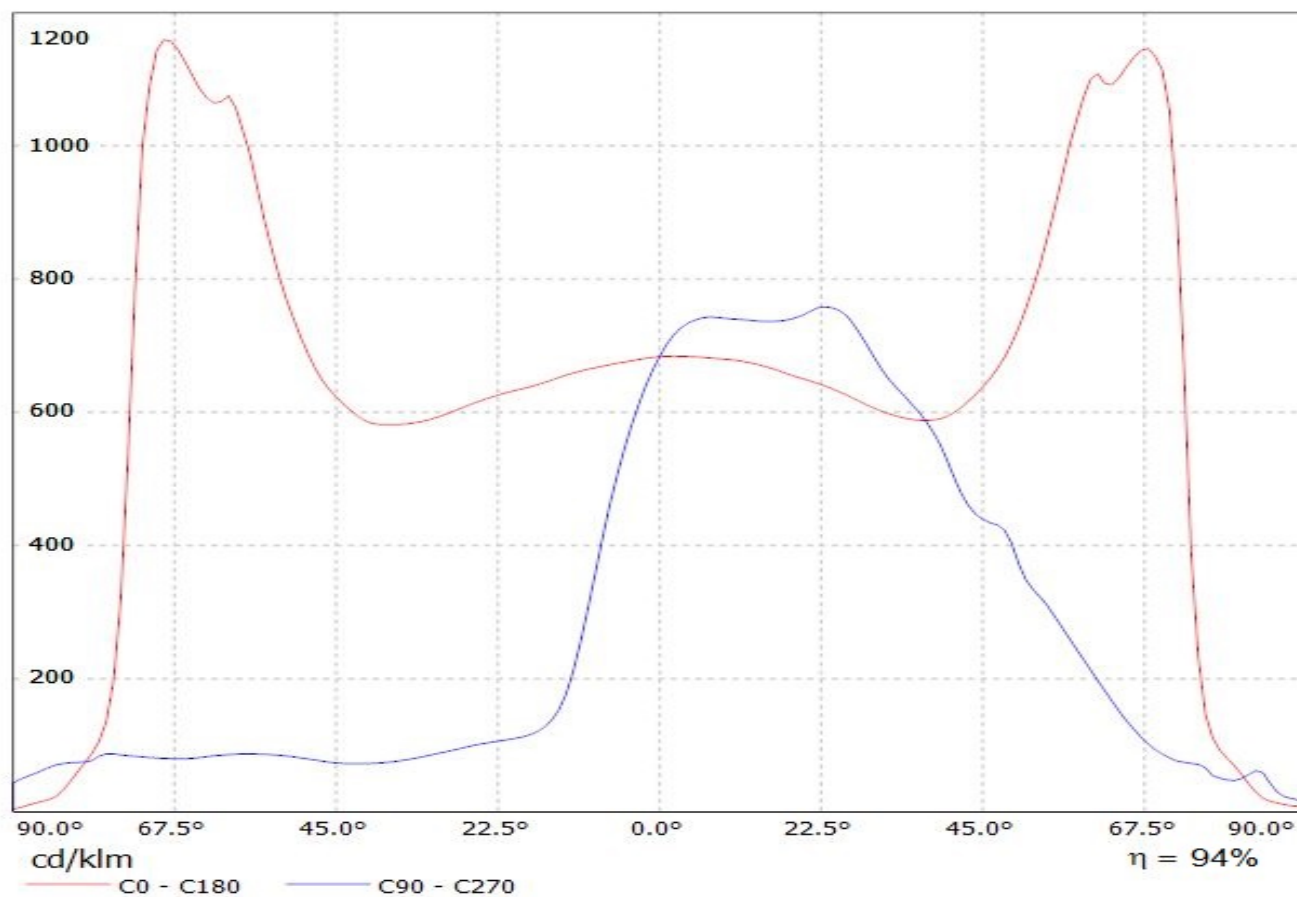

Luminaire: Ledil Oy C12362_STRADA-2X2-DWC (Cree XT-E AWT 409lm @ 250mA)
Lamps: 1 x Cree XT-E AWT 409lm @ 250mA

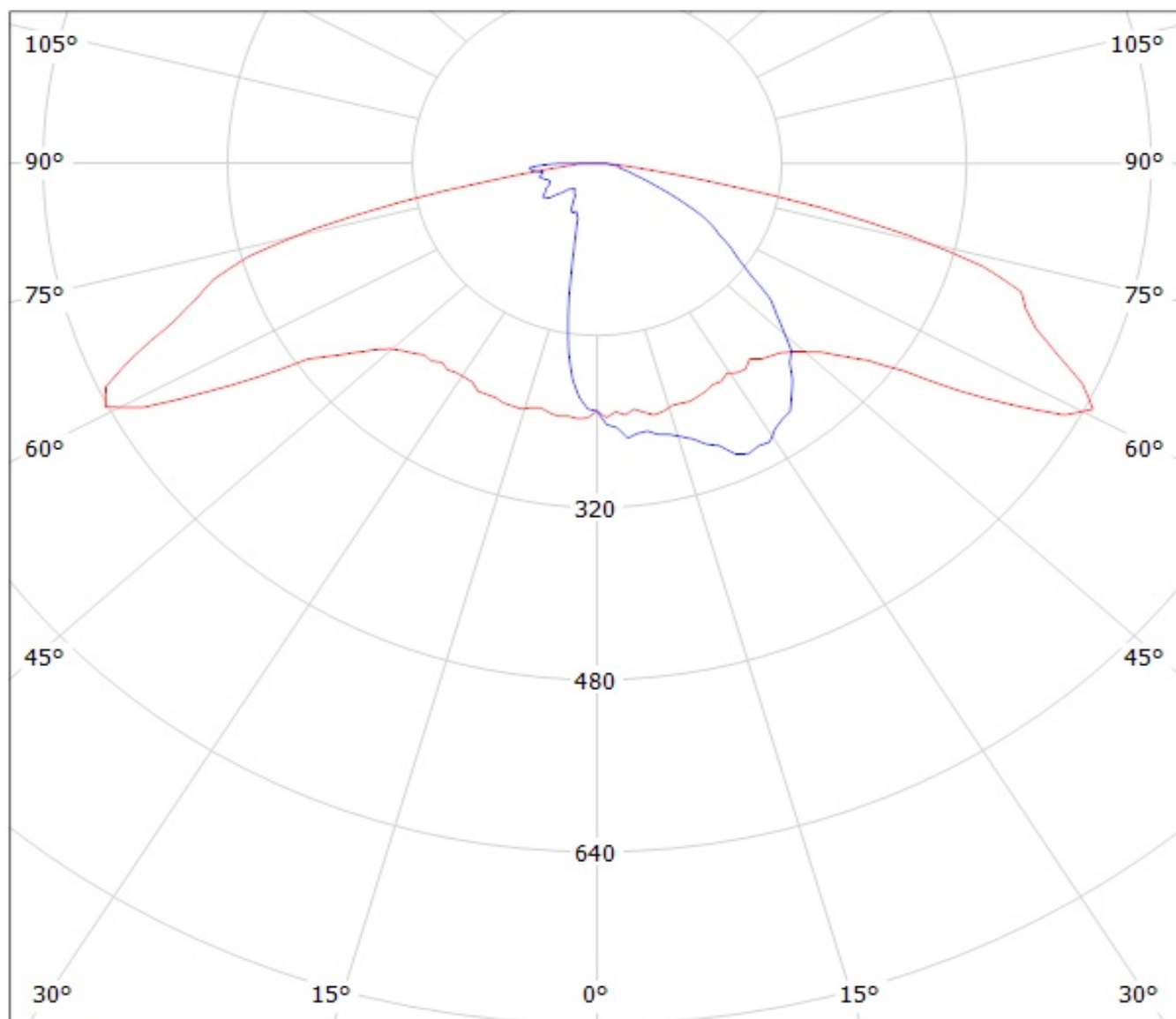

cd/klm

— C0 - C180

— C90 - C270

Luminaire: Ledil Oy C12362_STRADA-2X2-DWC (Cree XT-E HVW 1160lm @ 250mA) Efficiency=94%
Lamps: 1 x Cree XT-E HVW 1160lm @ 250mA

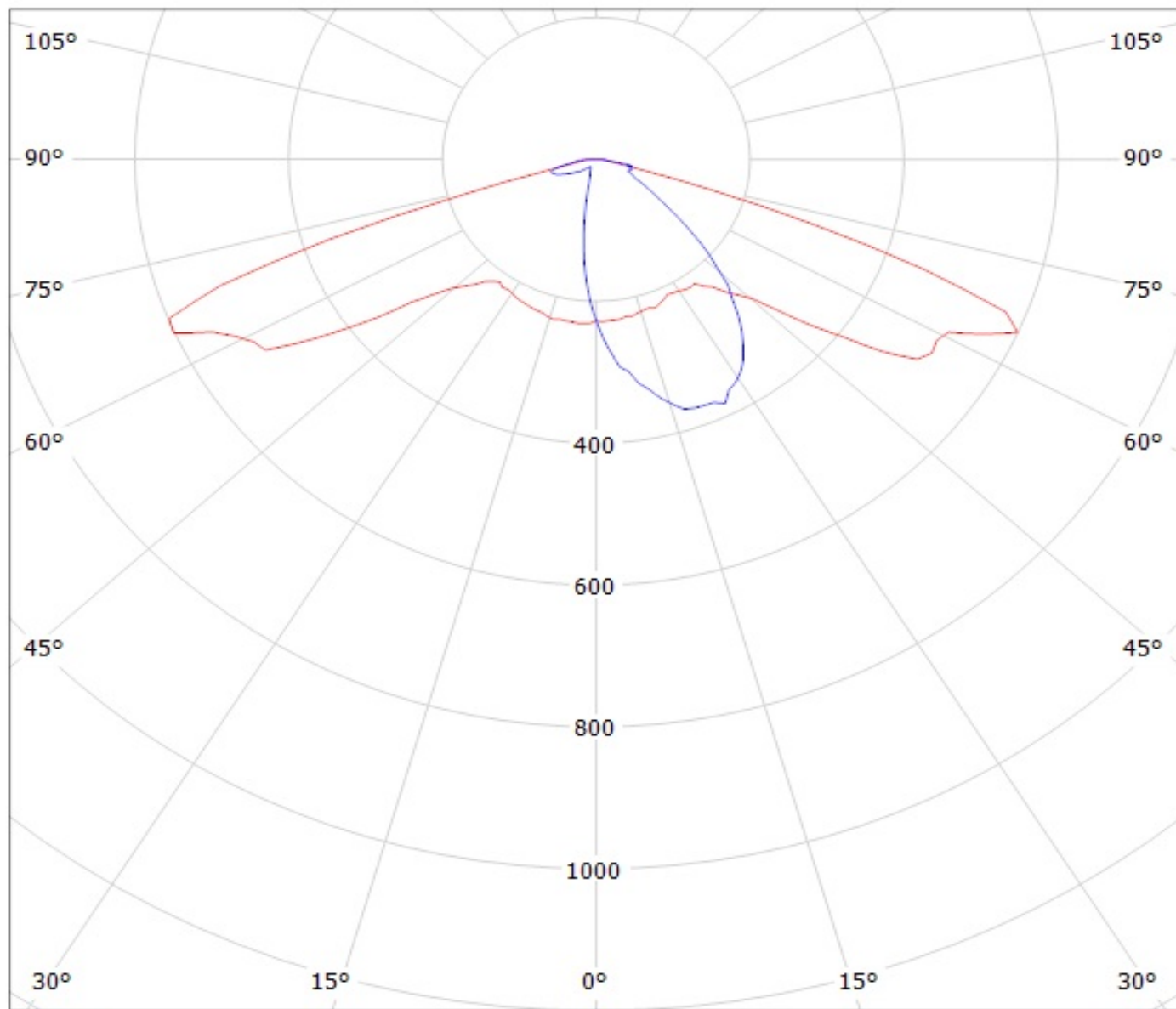

cd/klm

— C0 - C180

— C90 - C270

Luminaire: LEDil Oy C12362_STRADA-2X2-DWC_(XP-G2) Efficiency=94%
Lamps: 1 x Cree XP-G2 (XPGBWT-L1-00-00G51) 350lm @ 250mA CCT=7200K P=2.9W I=250mA

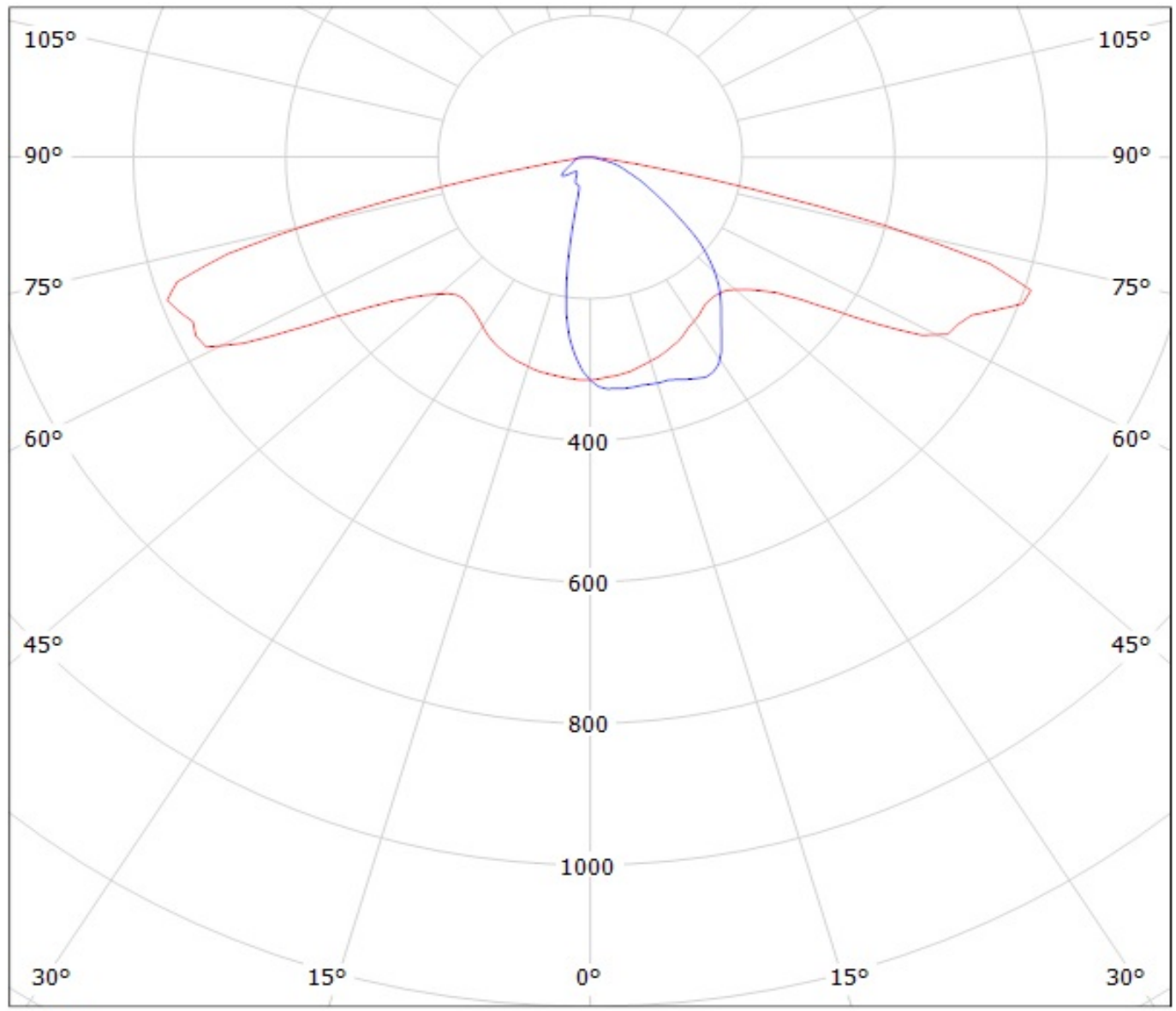

cd/klm
— C0 - C180 — C90 - C270

Luminaire: LEDiL Oy C12362_STRADA-2X2-DWC_(XP-L) Eff.94.2%

Lamps: 1 x CREE_XP-L_2x2_(XPLAWT-0-1B0-V40-00-0001)_504.373lm@250mA_CCT=7600K_P=2.79963W_I=249.9mA

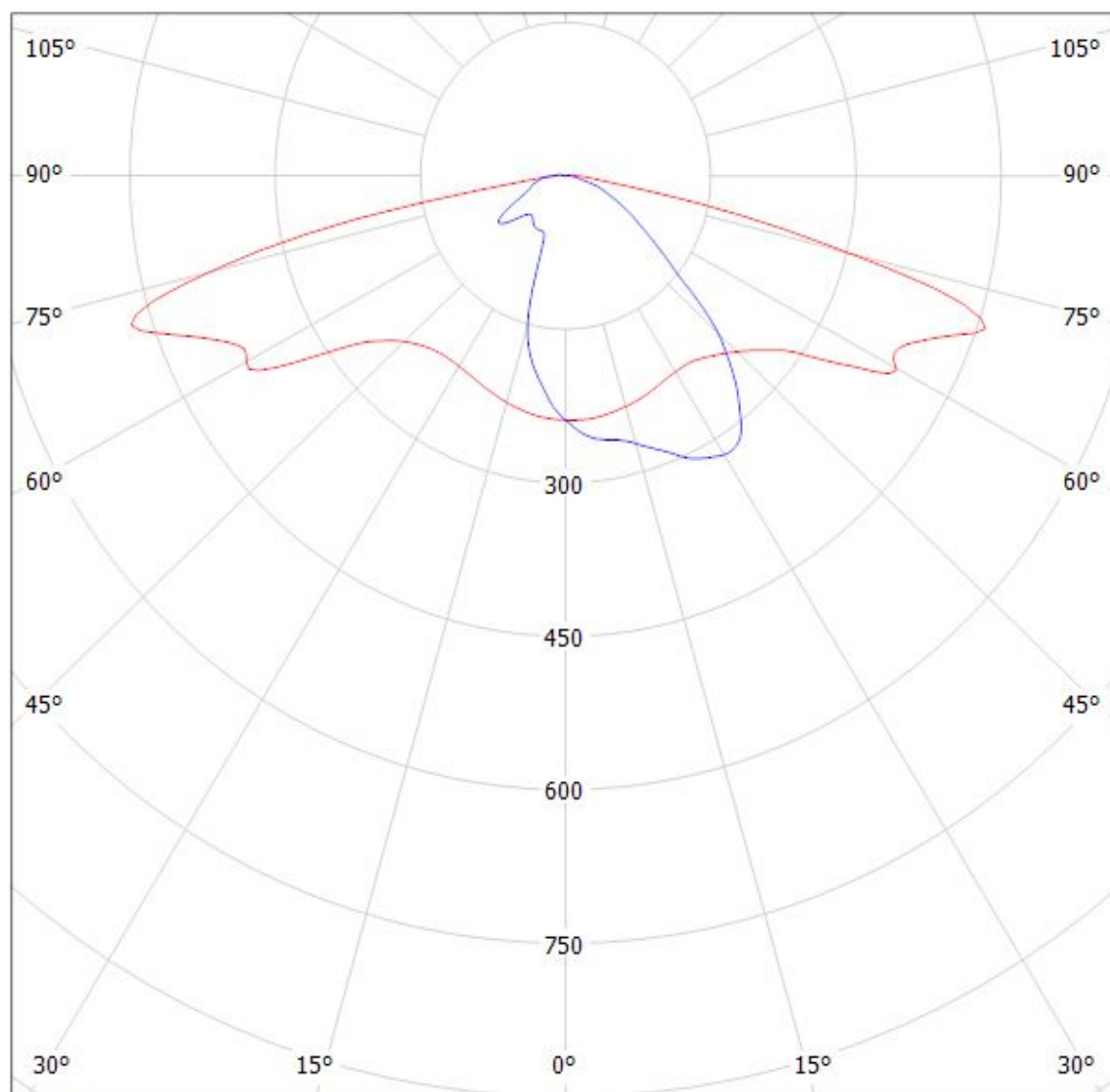

cd/klm

$\eta = 94\%$

— C0 - C180 — C90 - C270

Luminaire: LEDiL Oy C12362_STRADA-2X2-DWC_(XP-L_HI)
Lamps: 1 x Cree_XP-L_HI_(2x2)_(XPLAWT-H-5A3-U60-013-0001)
_455.077lm@250mA_P=2.84011W_I=0,2499A

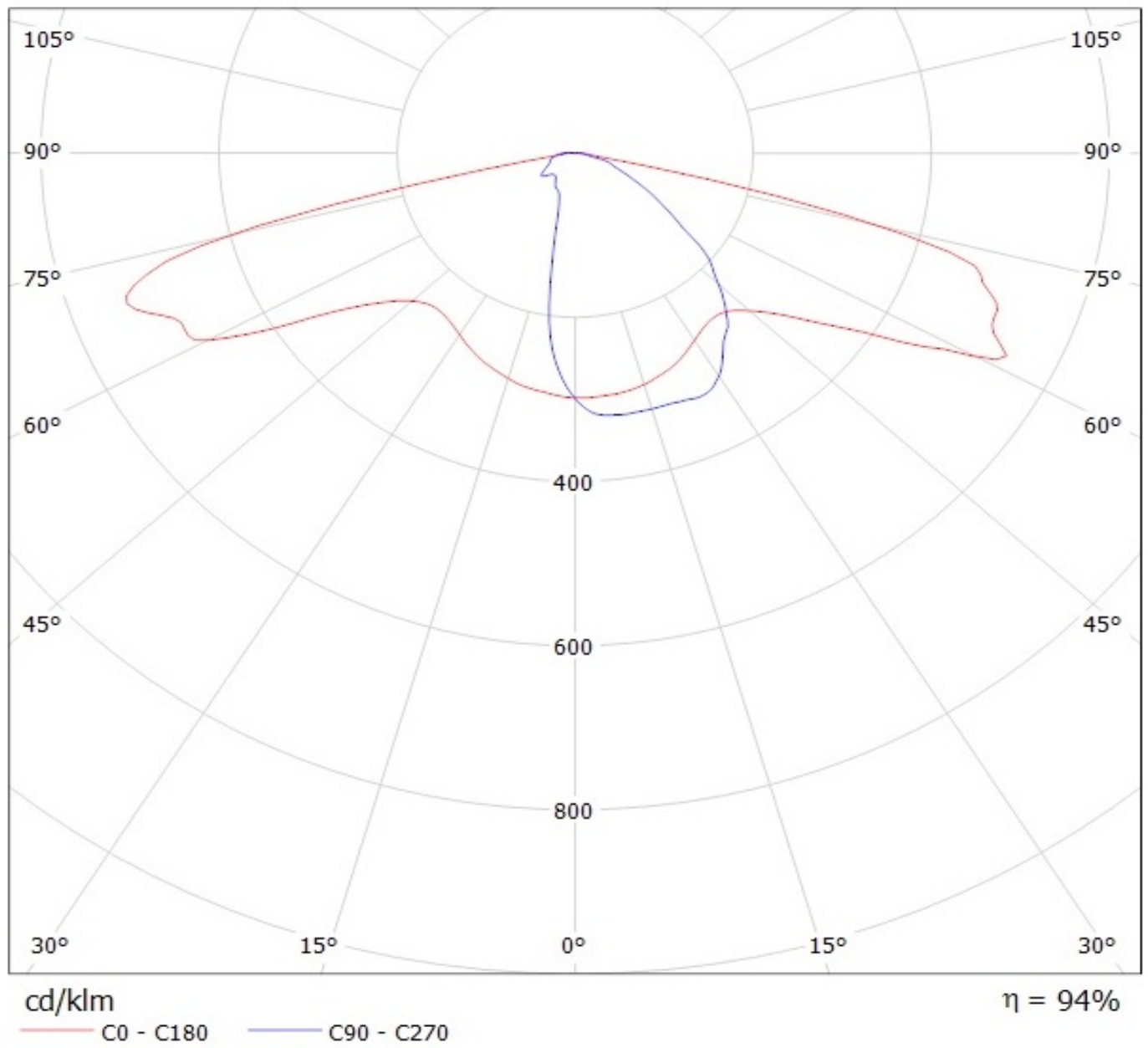

Luminaire: Ledil C12362_STRADA-2X2-DWC_(XHP35)
Lamps: 1 x Cree_XHP35-HD_2x2_(XHP35A-0-50E-D40-D0-H-01)
_1743.3lm@250mA_P=11.4855W_I=0.25A

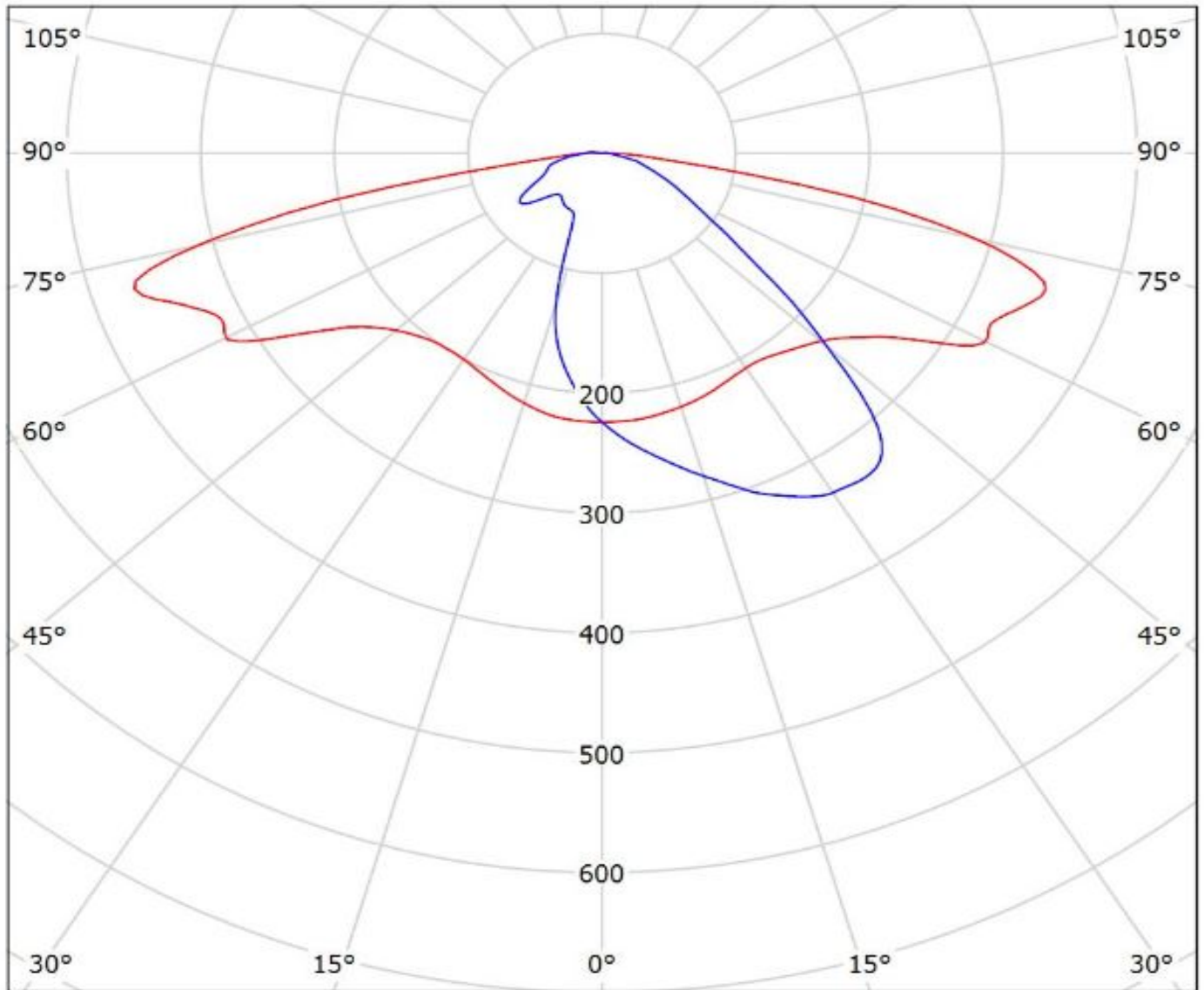

cd/klm

— C0 - C180 — C90 - C270

$\eta = 94\%$

Luminaire: Ledil Oy C12362_STRADA-2X2-DWC_(XHP35_HI)_SIMULATED
Lamps: 1 x CREE XHP35 HI

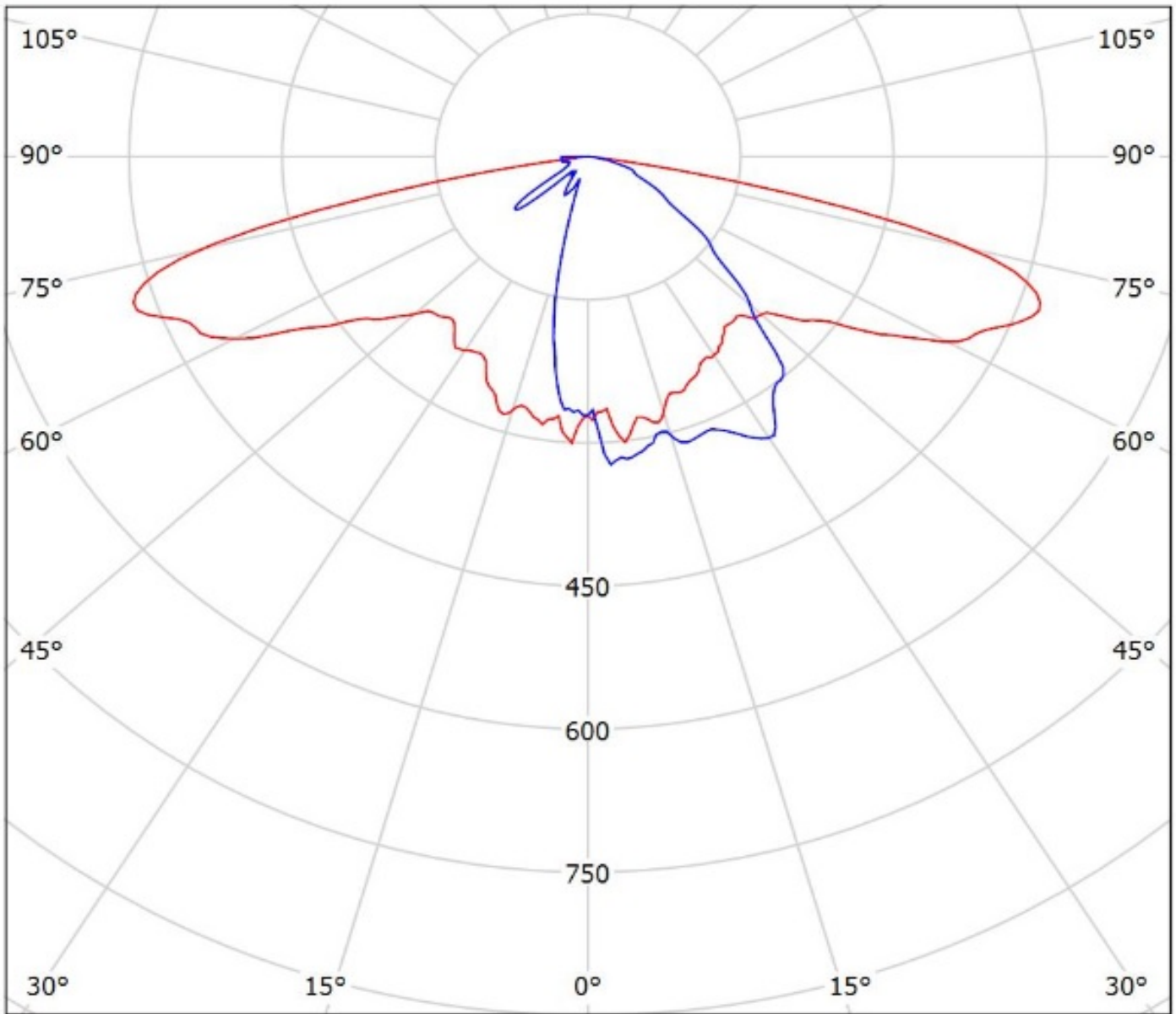

cd/klm

— C0 - C180 — C90 - C270

$\eta = 89\%$

Luminaire: LEDiL Oy C12362_STRADA-2X2-DWC_(XP-G3)

Lamps: 1 x XP-G3_(XPWDWTT-B1-3C0-S4-0-01)_501.192lm@250mA_P=2.76903W_I=0.250A

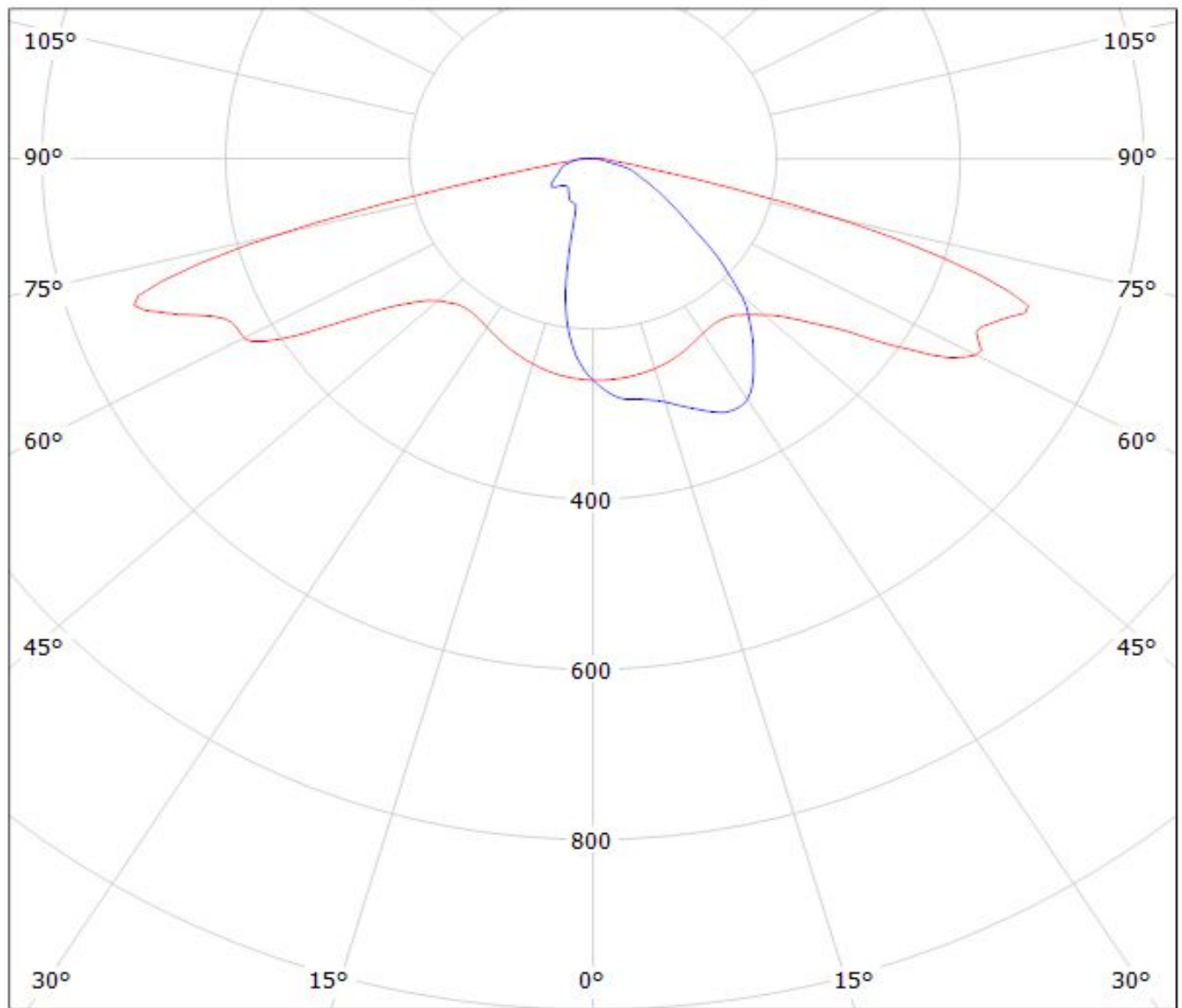

cd/klm

— C0 - C180

— C90 - C270

η = 96%

Luminaire: Ledil C12362_STRADA-2X2-DWC_(XP-L2)

Lamps: 1 x Cree_XP-L2_2x2_(XPLBWT-00-0000-000BV50E3)550.93lm@250mA_P=2.7815W_I=0.25A

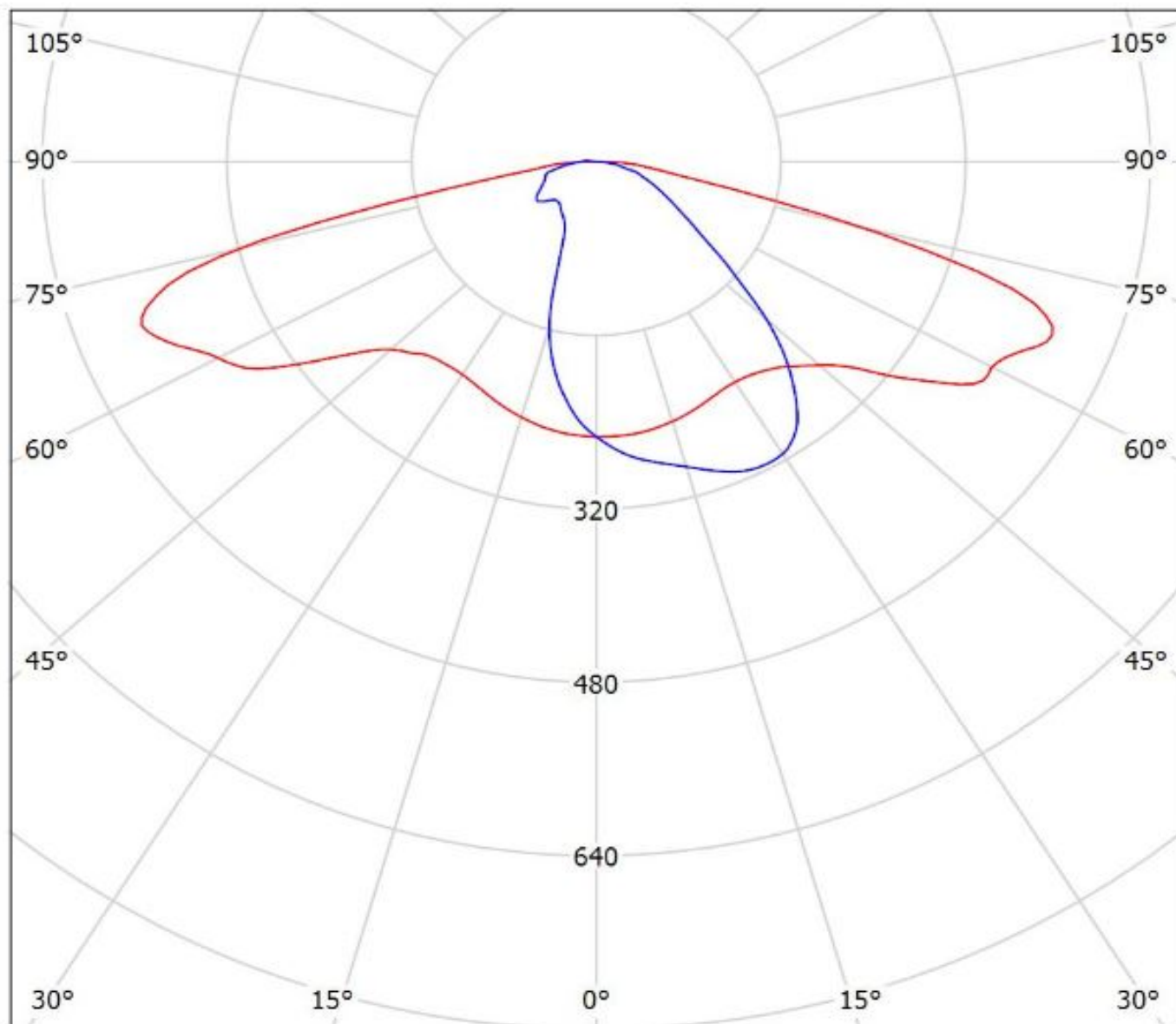

cd/klm

— C0 - C180 — C90 - C270

$\eta = 96\%$

Luminaire: LEDiL Oy C12362_STRADA-2X2-DWC_(LG3535) Eff. 93,8%
Lamps: 1 x LG Ceramic 3535 PKG (372lm@250mA)

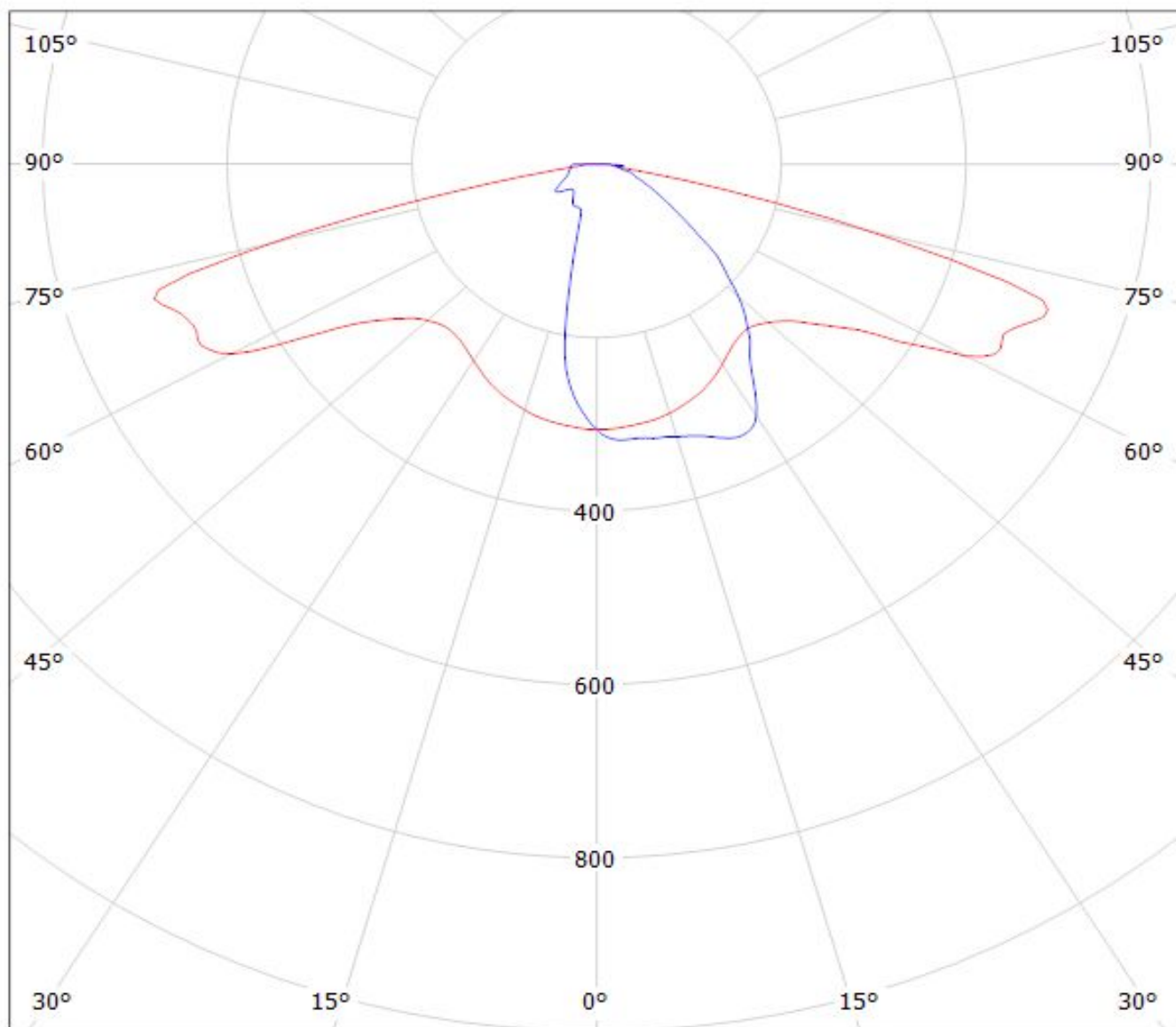

cd/klm

η = 94%

— C0 - C180 — C90 - C270

Luminaire: Ledil C12362_STRADA-2X2-DWC_(H35C1)

Lamps: 1 x LG_H35C1_2x2_477.216lm@250mA_P=2.87475W_I=0.250A

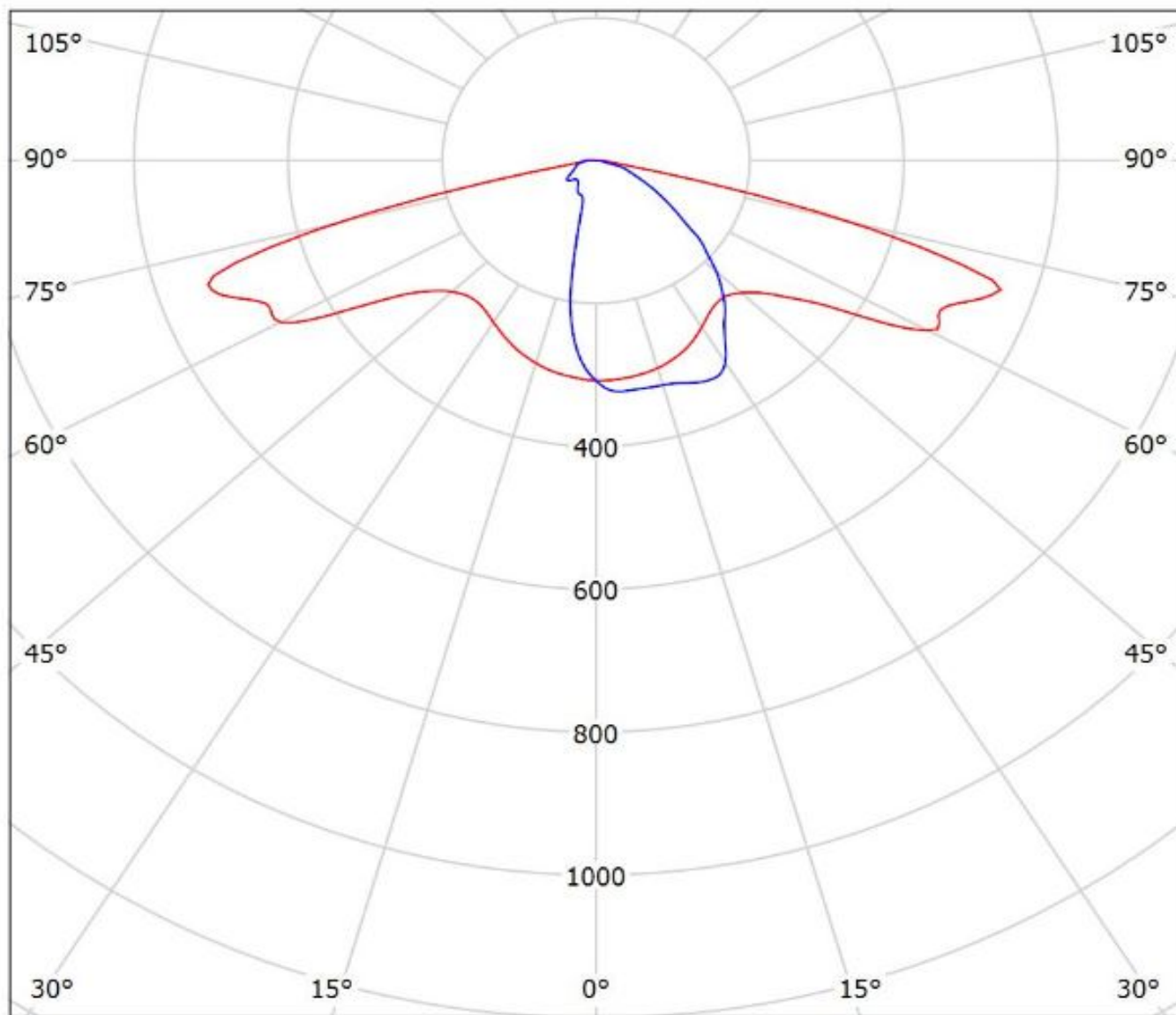

cd/klm

$\eta = 94\%$

— C0 - C180 — C90 - C270

Luminaire: Ledil Oy C12362_STRADA-2X2-DWC-RE-ES Efficiency=93%

Lamps: 1 x Luxeon Rebel ES 250mA 366lm

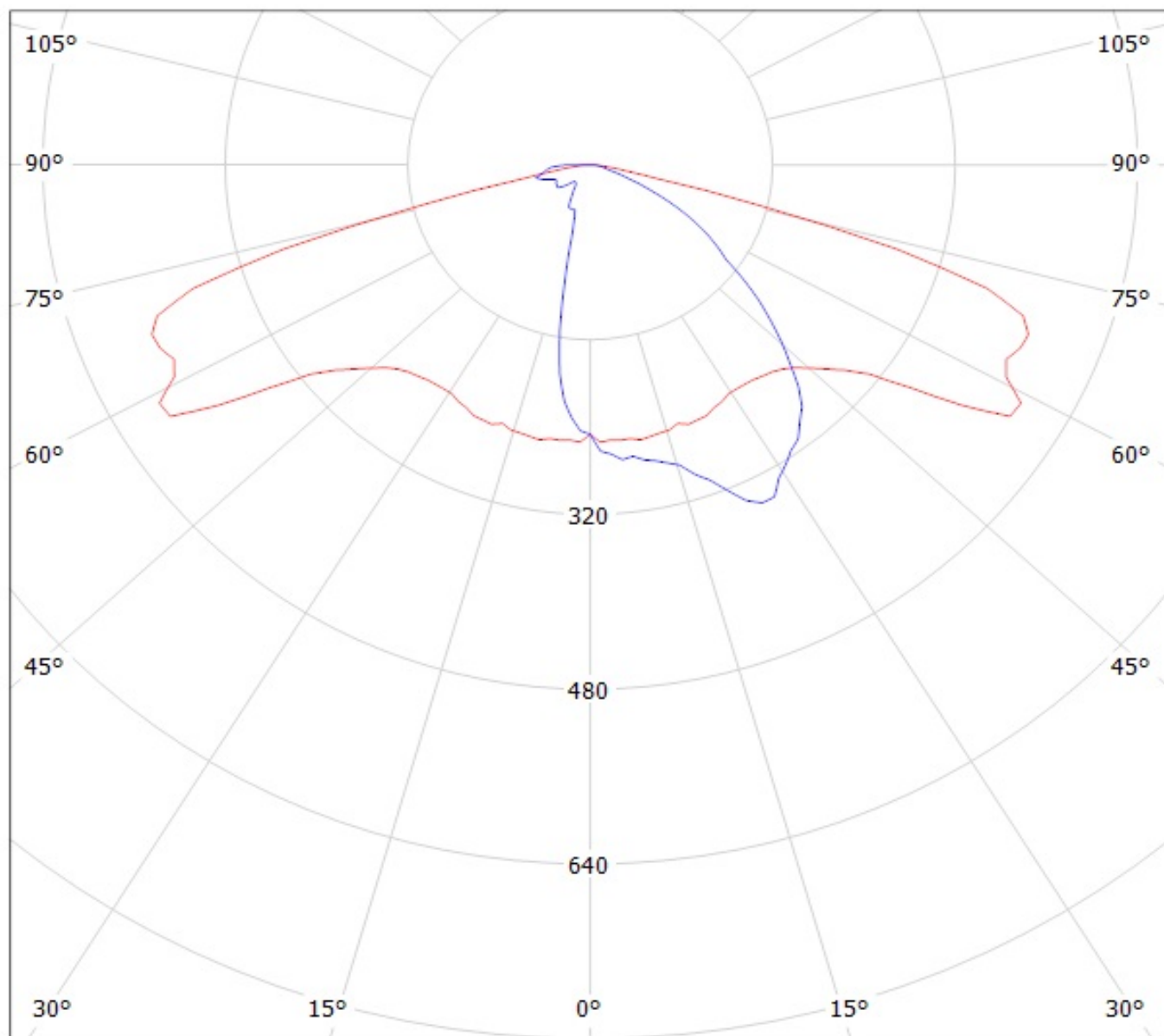

cd/klm

— C0 - C180

— C90 - C270

Luminaire: LEDiL Oy C12362_Strada-2x2-DWC_(LUXEON_T)_2 Eff.93.0%
Lamps: 1 x LUXEON_T 2x2 (294lm@250mA)

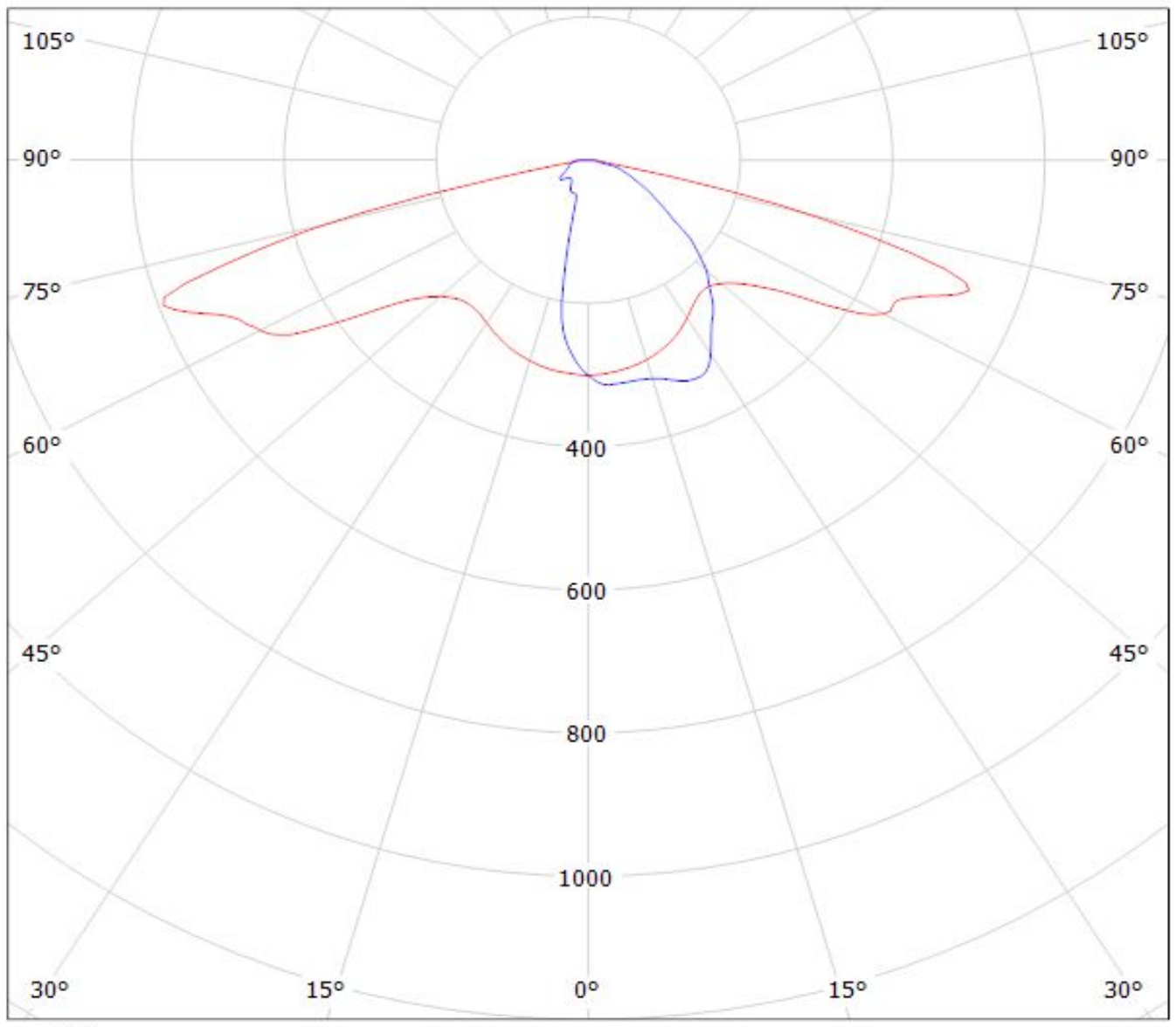

cd/klm

— C0 - C180 — C90 - C270

$\eta = 93\%$

Luminaire: LEDiL Oy C12362_STRADA-2x2-DWC_(LUXEON_Q)

Lamps: 1 x LUXEON_Q_2x2_(LHQ-3080)_299.038lm@250mA_P=2.8742W_I=249.8mA

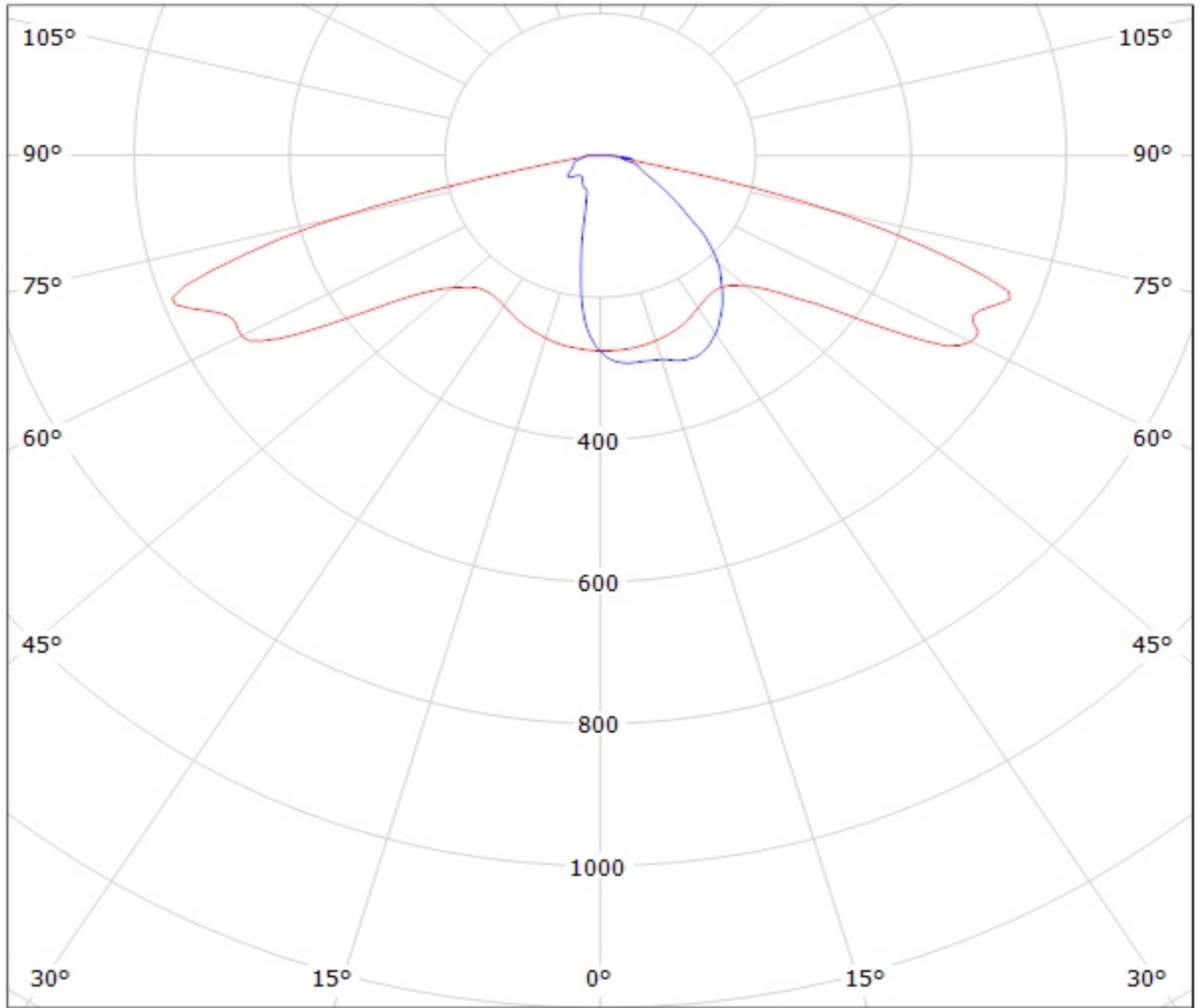

cd/klm

— C0 - C180

— C90 - C270

Luminaire: LEDiL Oy C12362_STRADA-2X2-DWC_(Luxeon_TX)
Lamps: 1 x Luxeon_TX_2x2_321.384lm@250mA_P=2.79488W_I=249.9mA

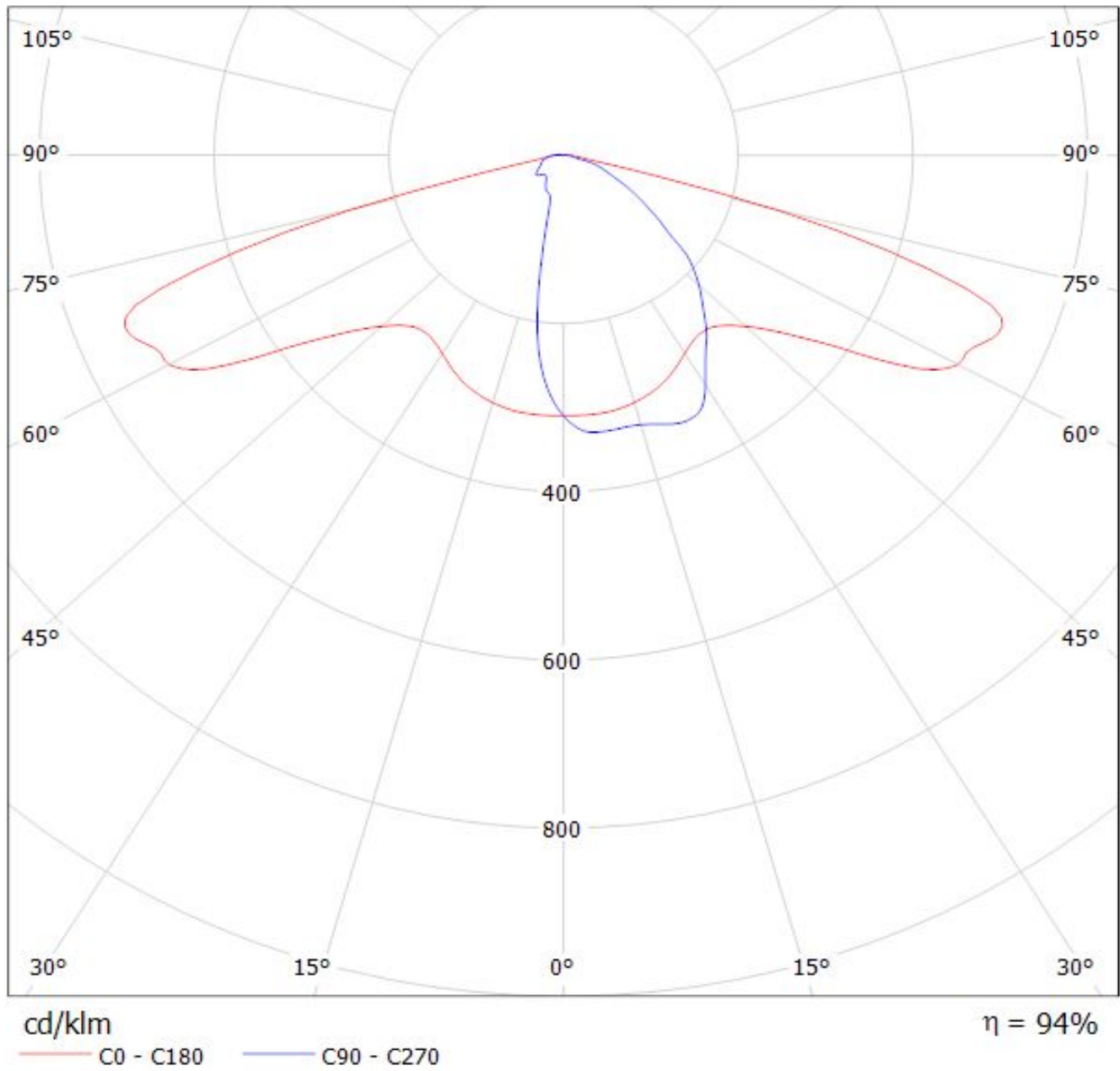

Luminaire: LEDiL Oy C12362_STRADA-2X2-DWC_(LUXEON_MZ) Eff.94.0%

Lamps: 1 x LUXEON_MZ_2x2_(LMZ7-QW57)_415lm@250mA_P=2.71916W_CCT=5700K_I=249.9mA

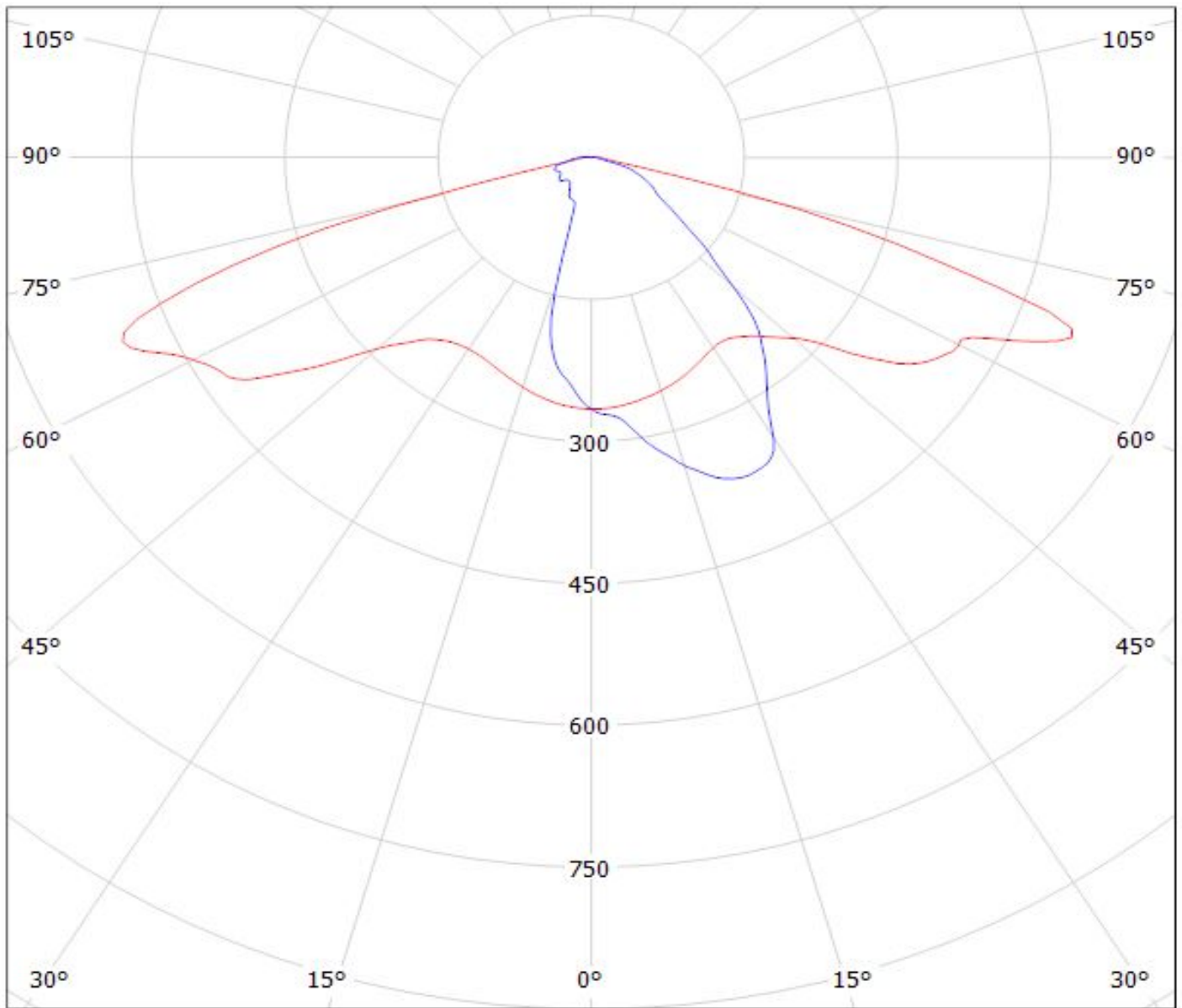

cd/klm

— C0 - C180

— C90 - C270

$\eta = 94\%$

Luminaire: LEDiL Oy C12362_STRADA-2X2-DWC_(Luxeon_5050)

Lamps: 1 x Luxeon_5050_2x2_1270.76lm@80mA_CCT=5700K_P=7.35815W_I=0.080A_70CRI

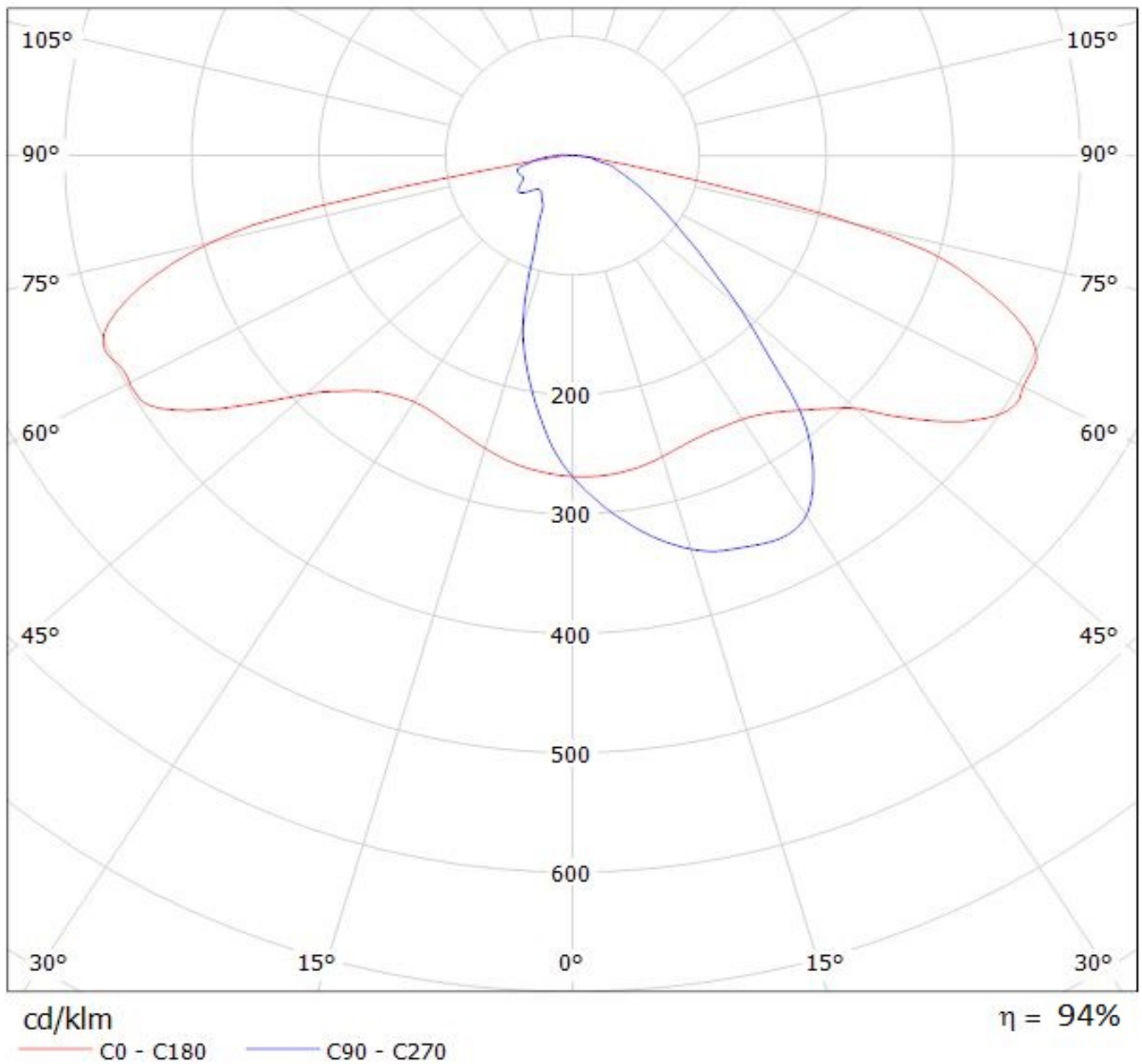

**LEDiL Oy C12362_STRADA-2x2-DWC_(NICHIA_NS9x383) Eff.95.1% / LDC
(Polar)**

Luminaire: LEDiL Oy C12362_STRADA-2x2-DWC_(NICHIA_NS9x383) Eff.95.1%
Lamps: 1 x NICHIA_NS9x383 (287.074lm@250mA)

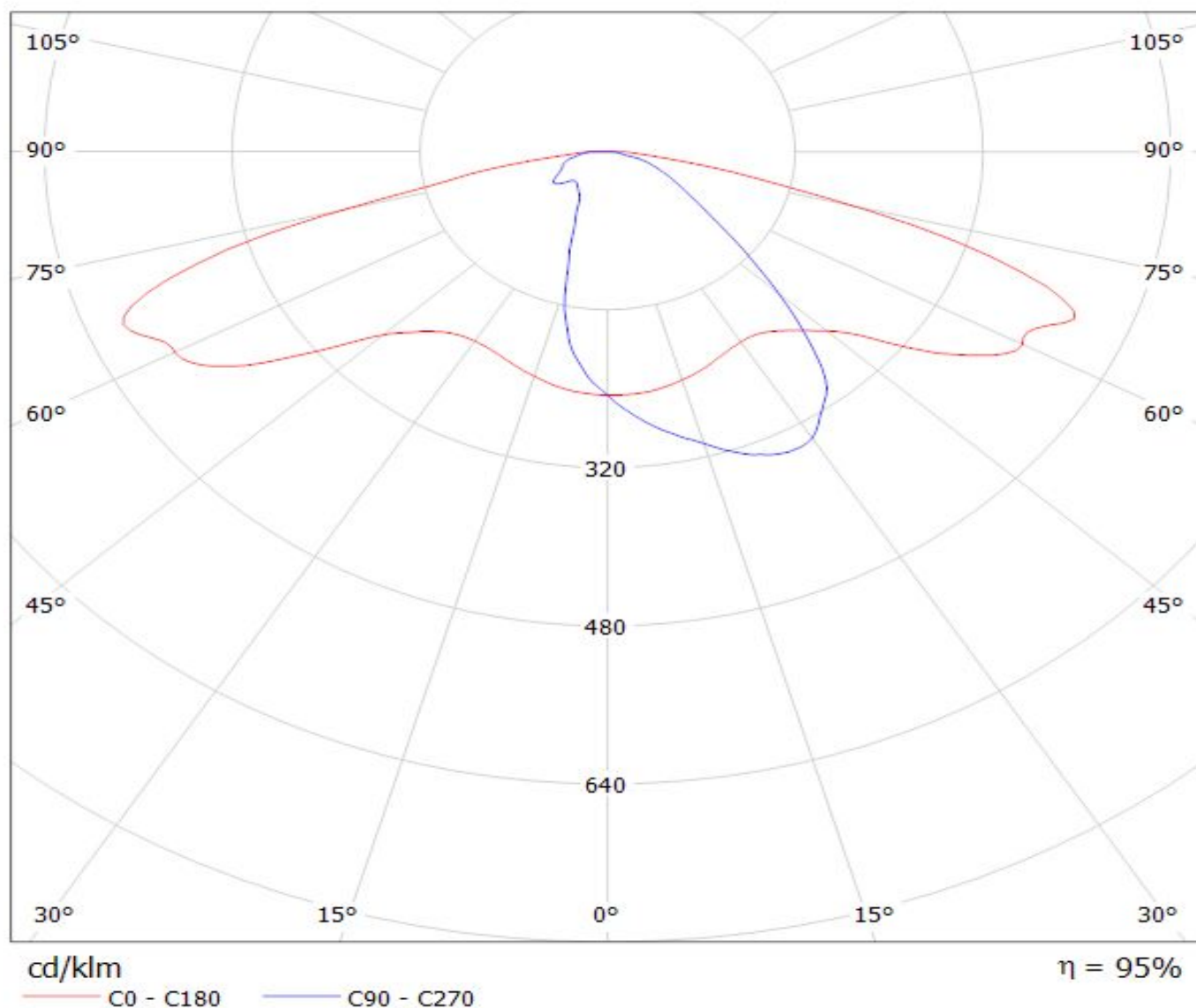

Ledil C12362_STRADA-2X2-DWC_(NVSL219BE) / LDC (Polar)

Luminaire: Ledil C12362_STRADA-2X2-DWC_(NVSL219BE)

Lamps: 1 x Nichia_NVSL219BE_319.707lm@250mA_CCT=3071K_P=2.8910W_I=0.25A

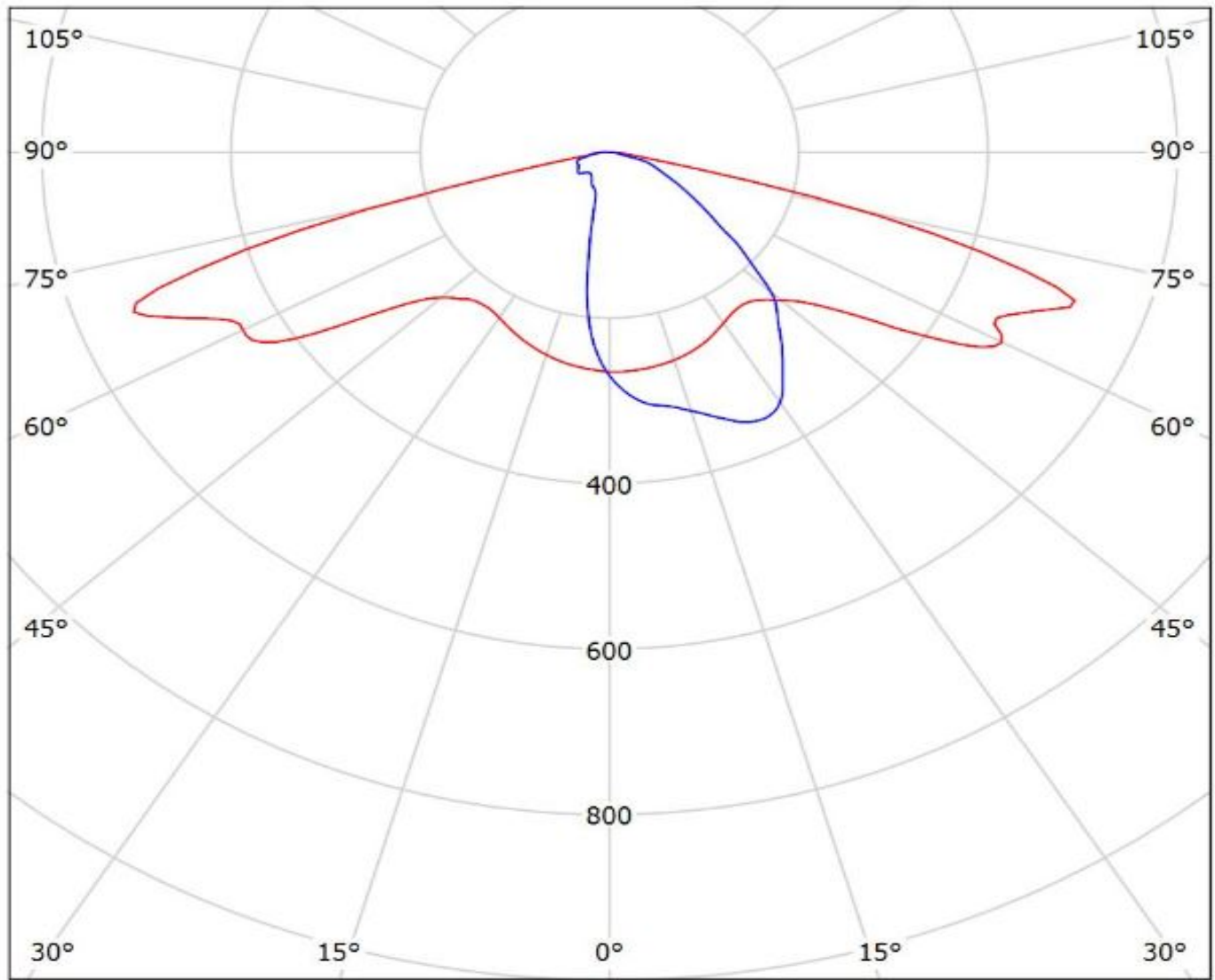

cd/klm

— C0 - C180 — C90 - C270

$\eta = 95\%$

Luminaire: LEDiL Oy C12362_STRADA-2X2-DWC_(NWSL229AE)_GS
Lamps: 1 x Nichia_NWSL229AE_476.846lm@250mA_P=2.75804W_I=0.250A

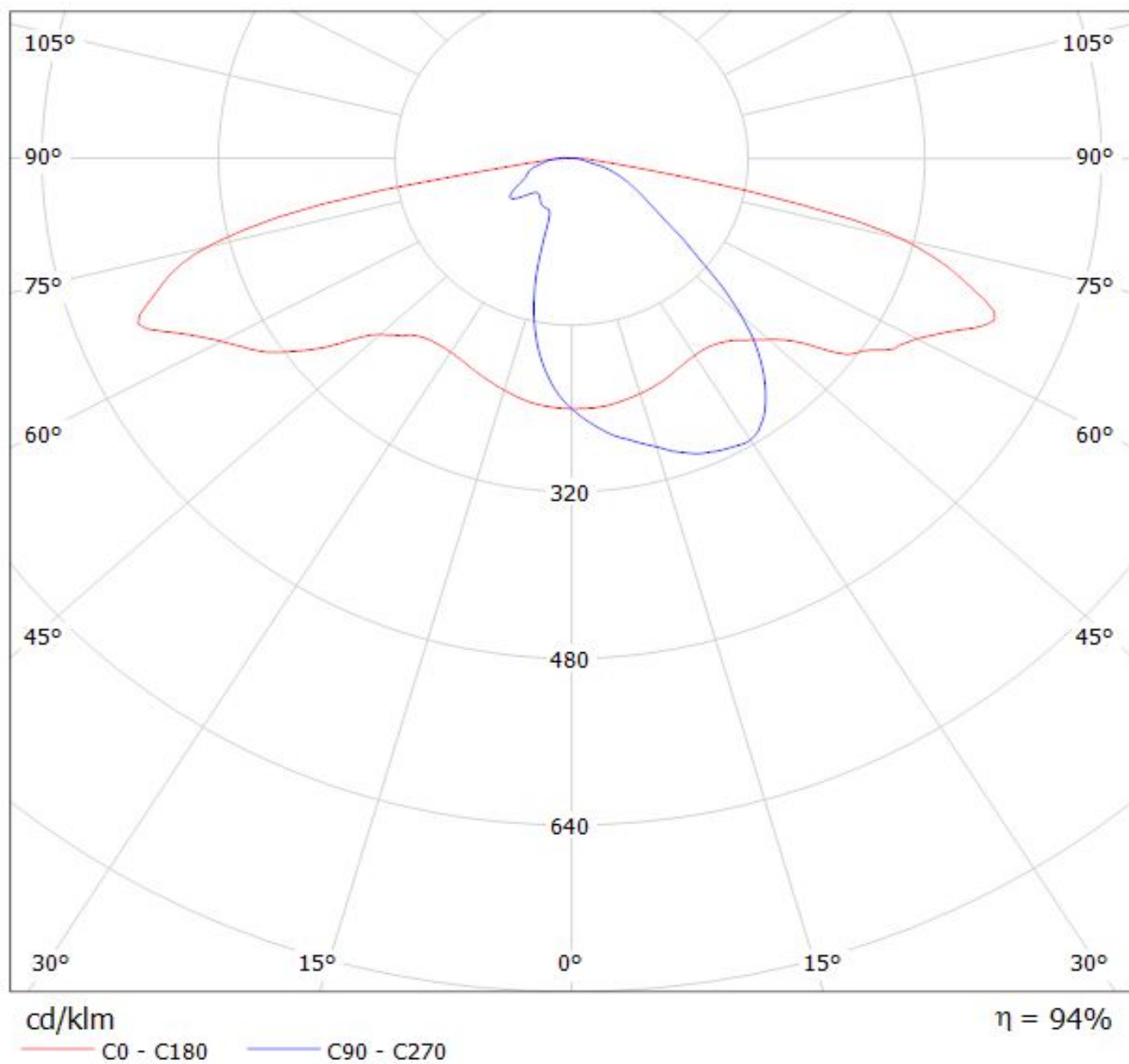

Luminaire: Ledil C12362_STRADA-2X2-DWC_(NVSW319AE)

Lamps: 1 x Nichia_NVSW319AE_(sm405D440f2L2R70)_516.263lm@250mA_P=2.82725W_I=0.250A

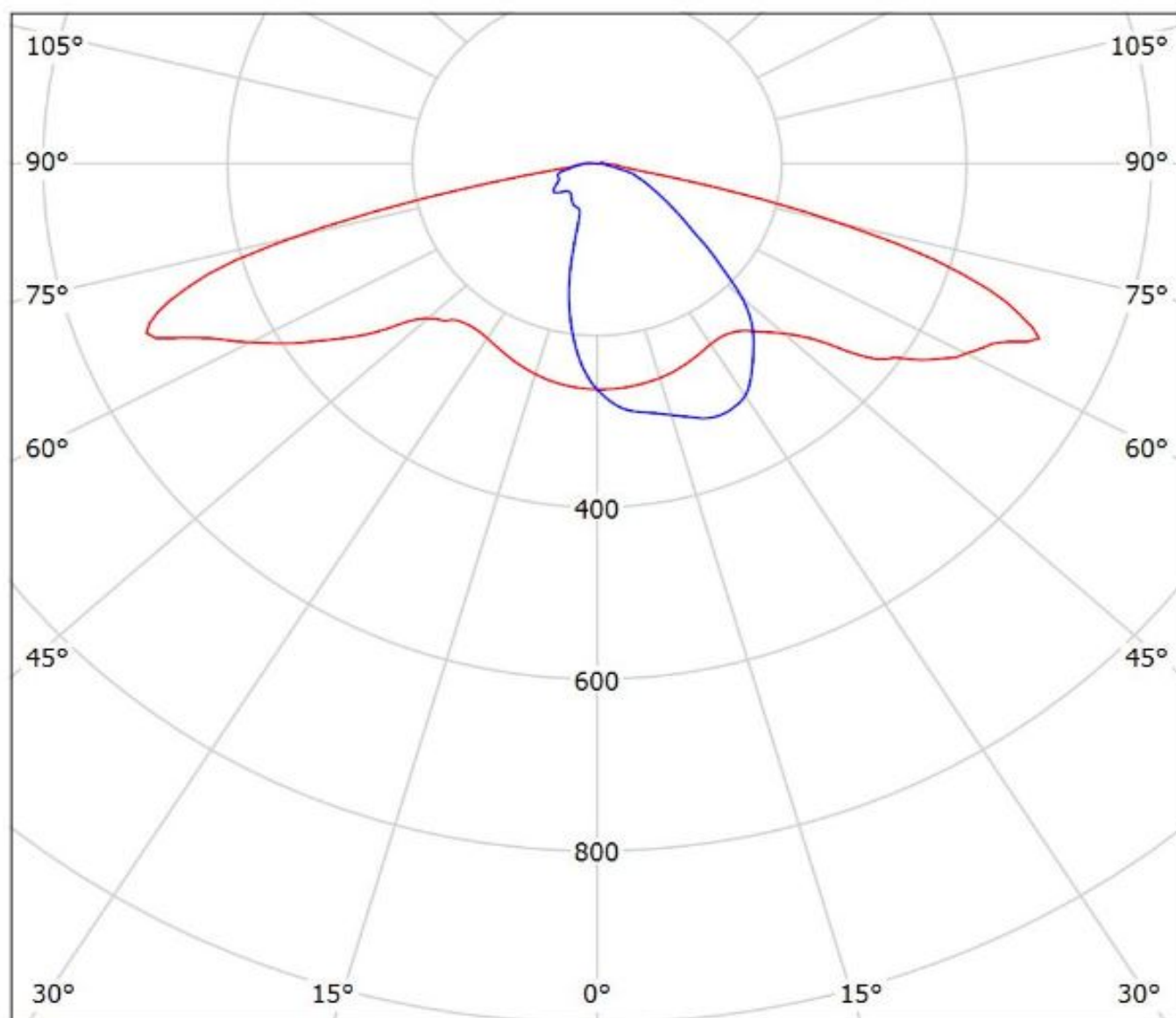

cd/klm

— C0 - C180 — C90 - C270

$\eta = 96\%$

Luminaire: LEDiL Oy C12362_STRADA-2X2-DWC_(E21A)

Lamps: 1 x Nichia_E21A_2x2_451.527lm@250mA_P=2.8055W_I=0.250A

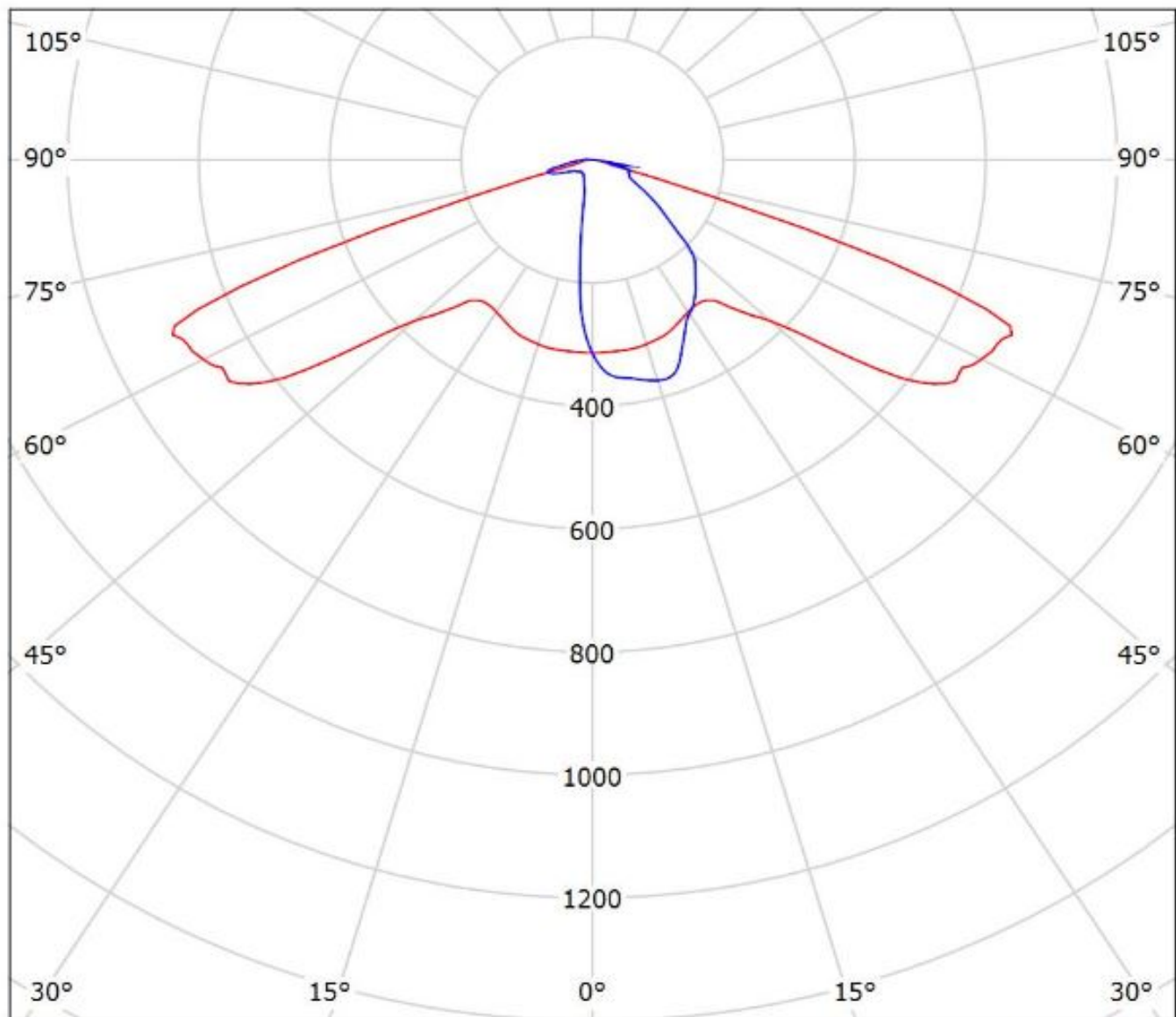

cd/klm

— C0 - C180 — C90 - C270

$\eta = 96\%$

Luminaire: Ledil Oy C12362_STRADA-2X2-DWC (Osram Square PC 398lm @ 250mA) Efficiency=92%
Lamps: 1 x Osram Square PC 398lm @ 250mA

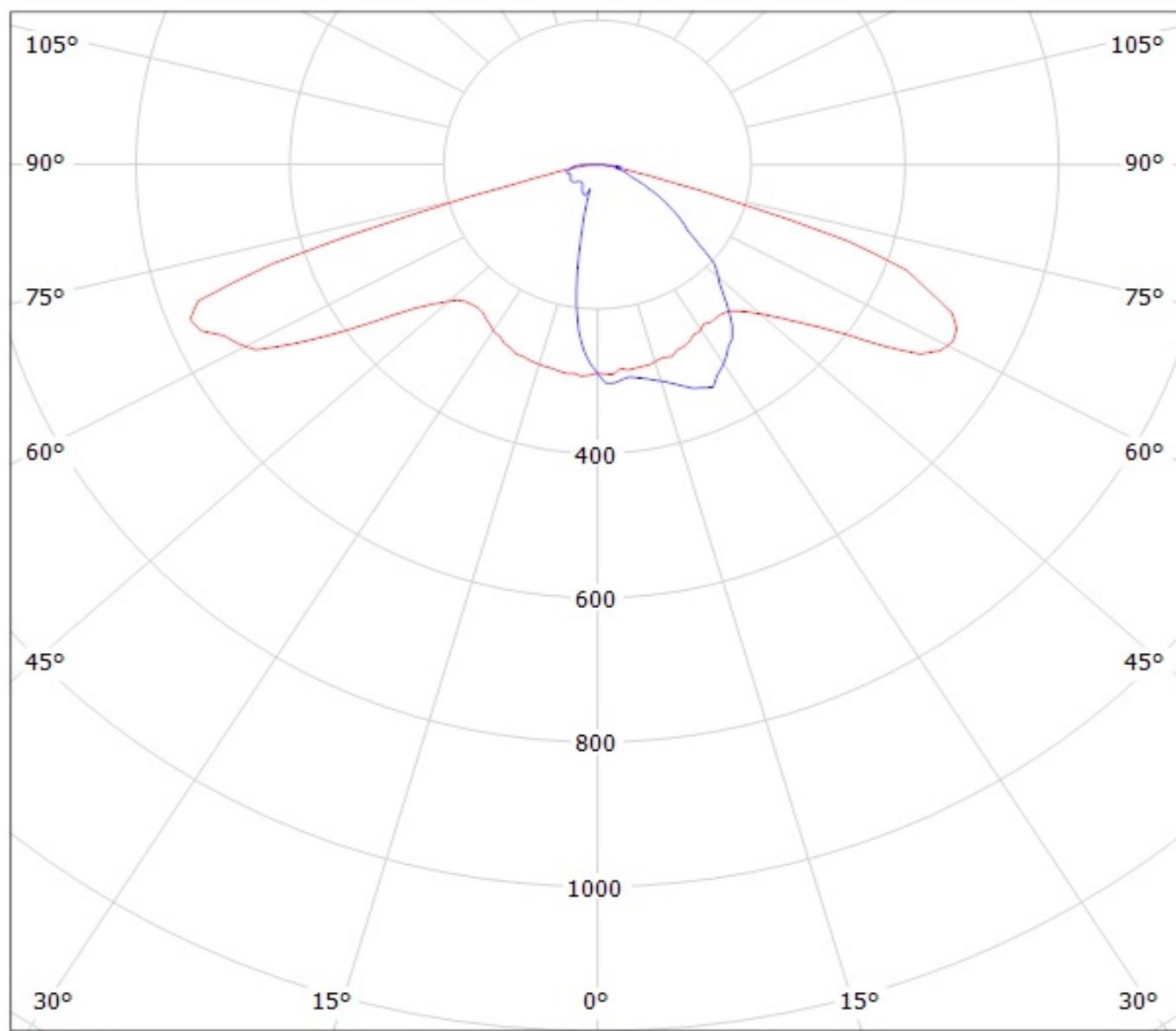

cd/klm

— C0 - C180

— C90 - C270

Luminaire: LEDiL Oy C12362_STRADA-2X2-DWC_(Square_Gen3)

Lamps: 1 x Osram_Square_Gen3_GW_CSSRM2.PM_450.897lm@250mA_P=2.788_I=250mA

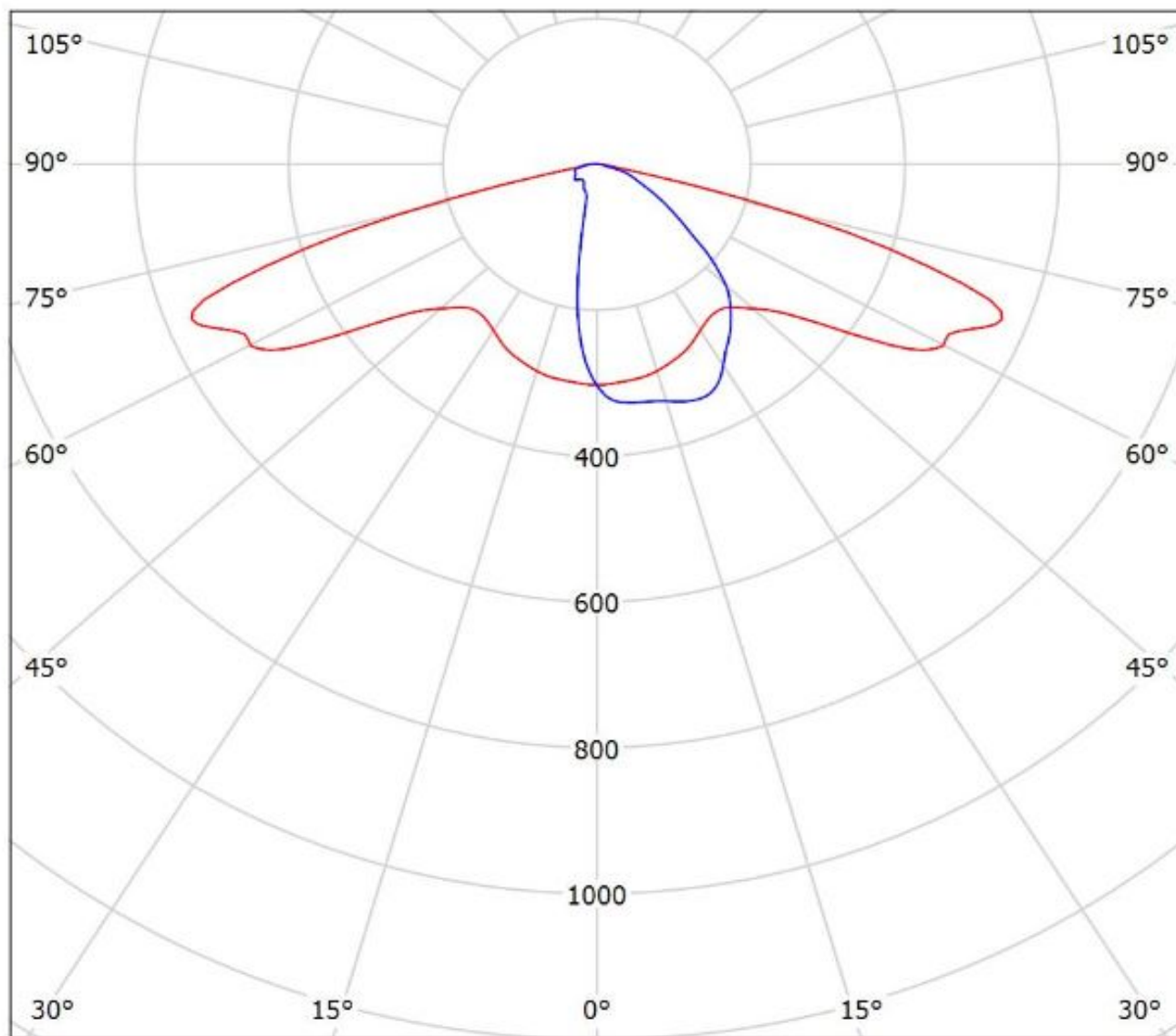

cd/klm

— C0 - C180

— C90 - C270

$\eta = 92\%$

Luminaire: Ledil Oy C12362_STRADA-2X2-DWC_(Duris_P8)_SIMULATED
Lamps: 1 x Osram Duris P8

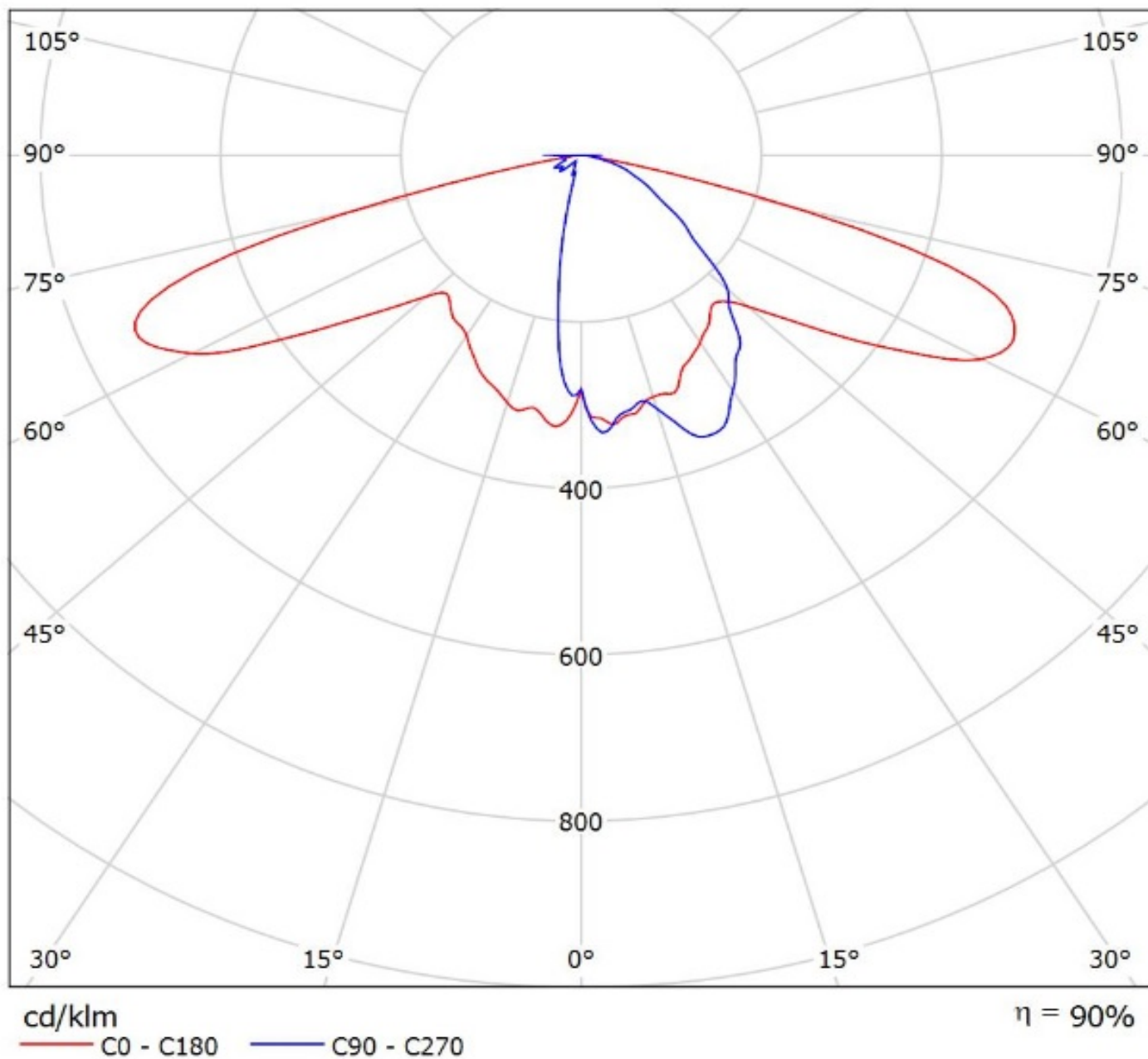

Luminaire: LEDiL Oy C12362_STRADA-2X2-DWC_(Fortimo_F-Flex_2x8_740DAG3)

Lamps: 1 x Philips_Fortimo_FastFlex_LED_board_2x8/740_DA_G3_1795.7lm@250mA_P=11.6015W_I=0.2498A

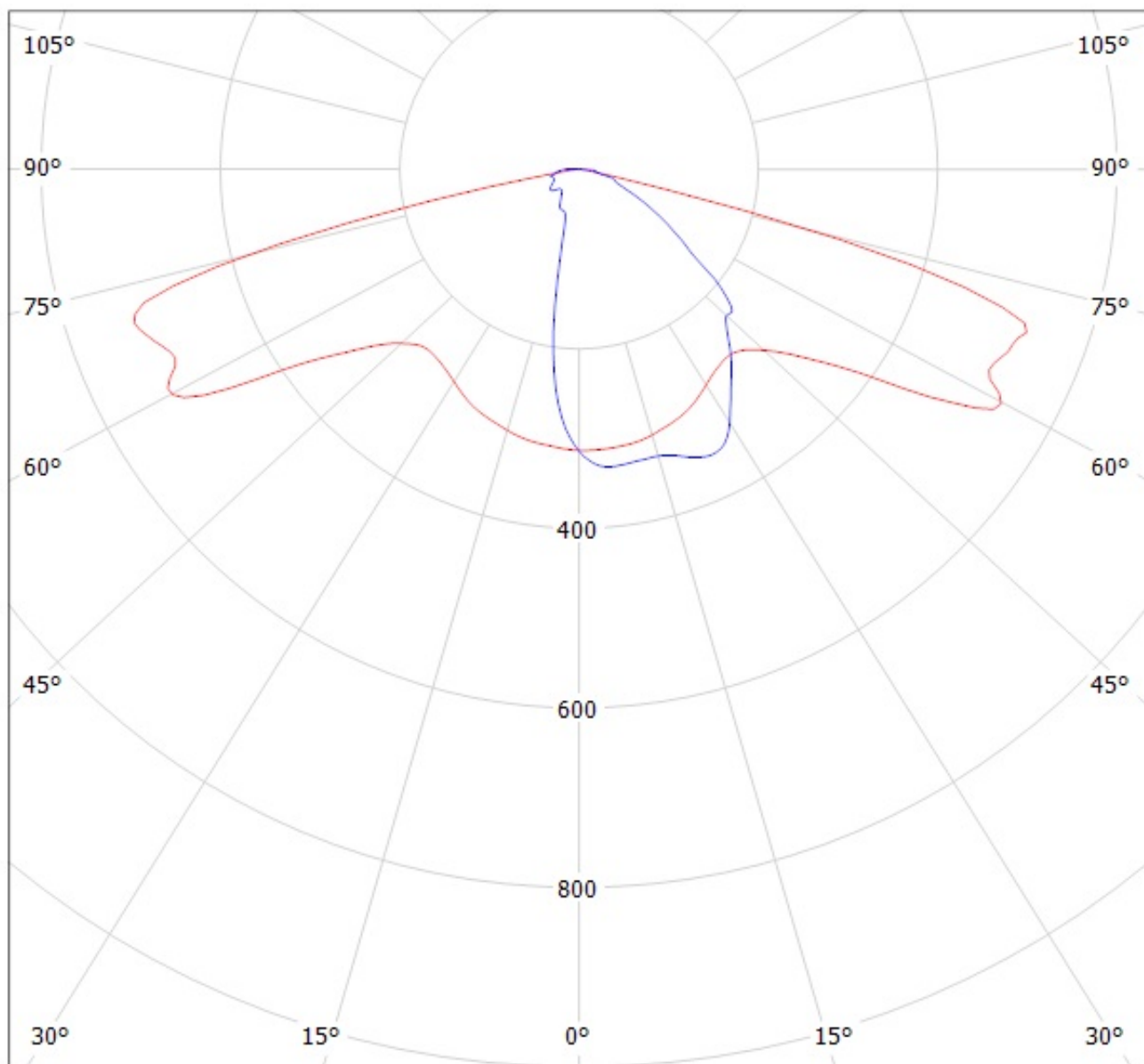

cd/klm

— C0 - C180

— C90 - C270

$\eta = 94\%$

Luminaire: LEDiL Oy C12362_STRADA-2X2-DWC_(LH351B) Eff.89.3%

Lamps: 1 x SAMSUNG_LH351B_2x2_430.715lm@250mA_P=2.84311W_I=249.9mA

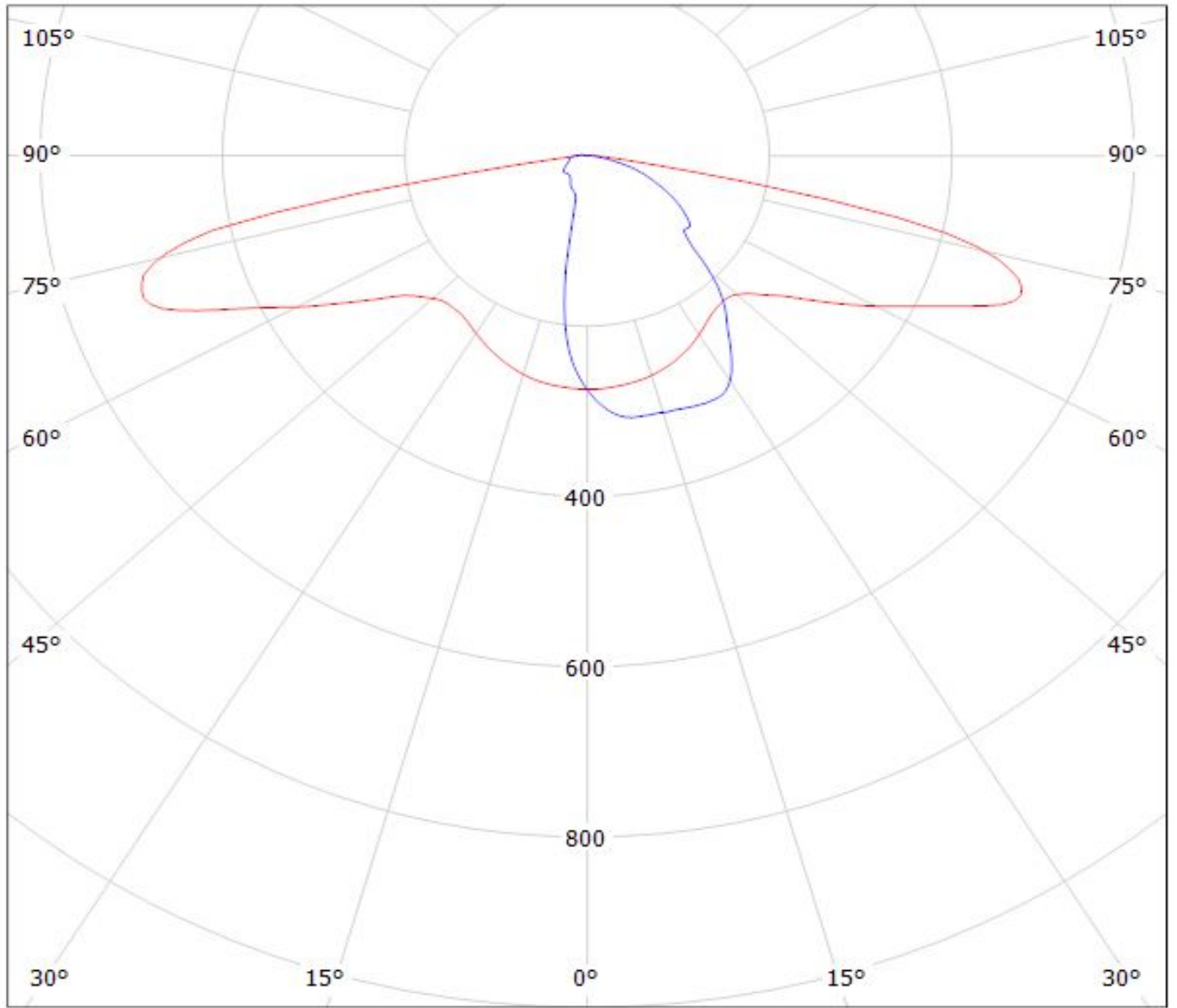

cd/klm

— C0 - C180

— C90 - C270

$\eta = 89\%$

Luminaire: LEDiL Oy C12362_STRADA-2X2-DWC_(LH351Z)

Lamps: 1 x SAMSUNG_LH351Z_2x2_360.93lm@250mA_P=2.86596W_I=249.8mA

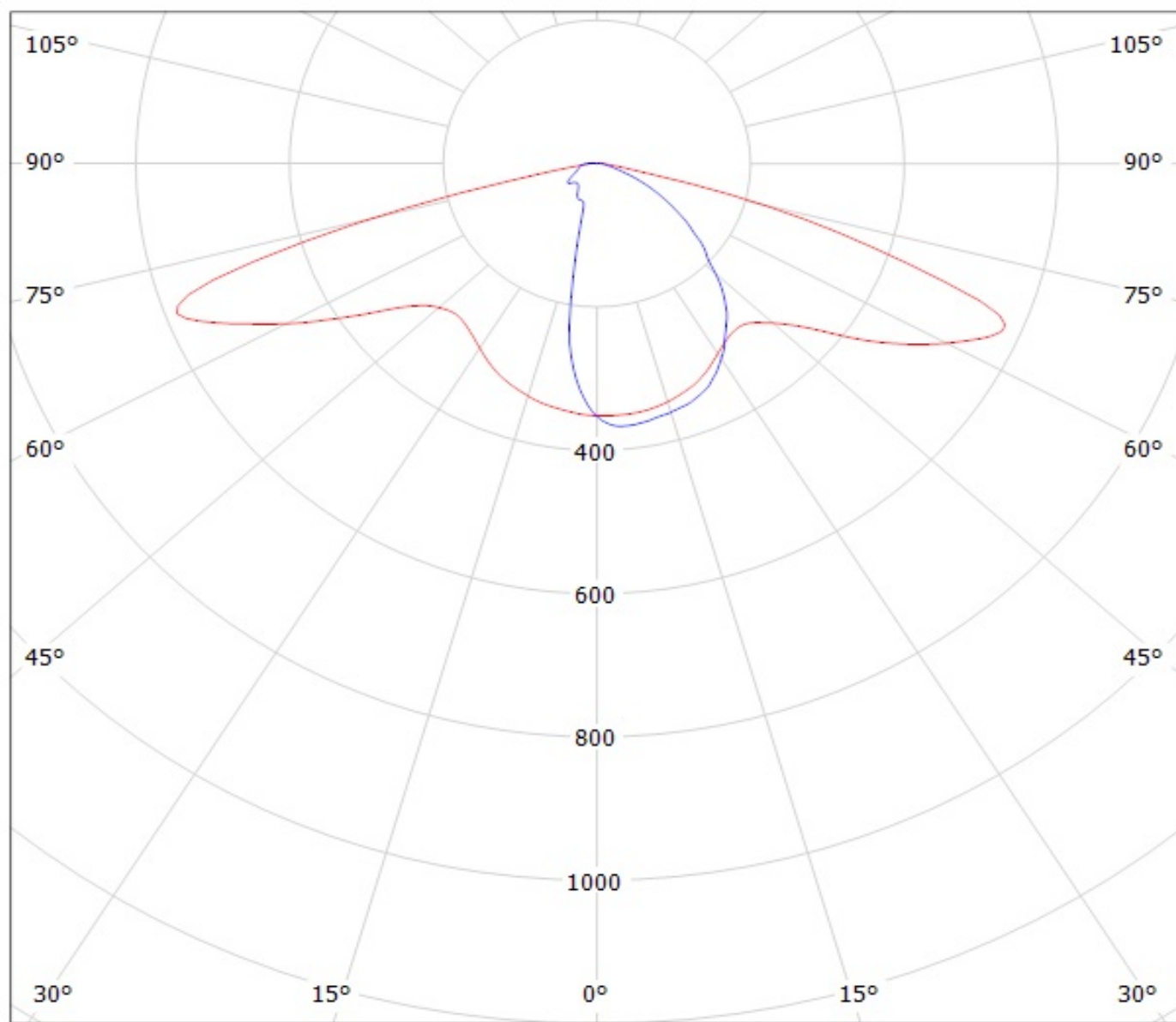

cd/klm

— C0 - C180

— C90 - C270

$\eta = 94\%$

Luminaire: Ledil C12362_STRADA-2X2-DWC_(LH351D)

Lamps: 1 x Samsung_LH351D_536.957lm@250mA_P=2.7695W_I=0.250A

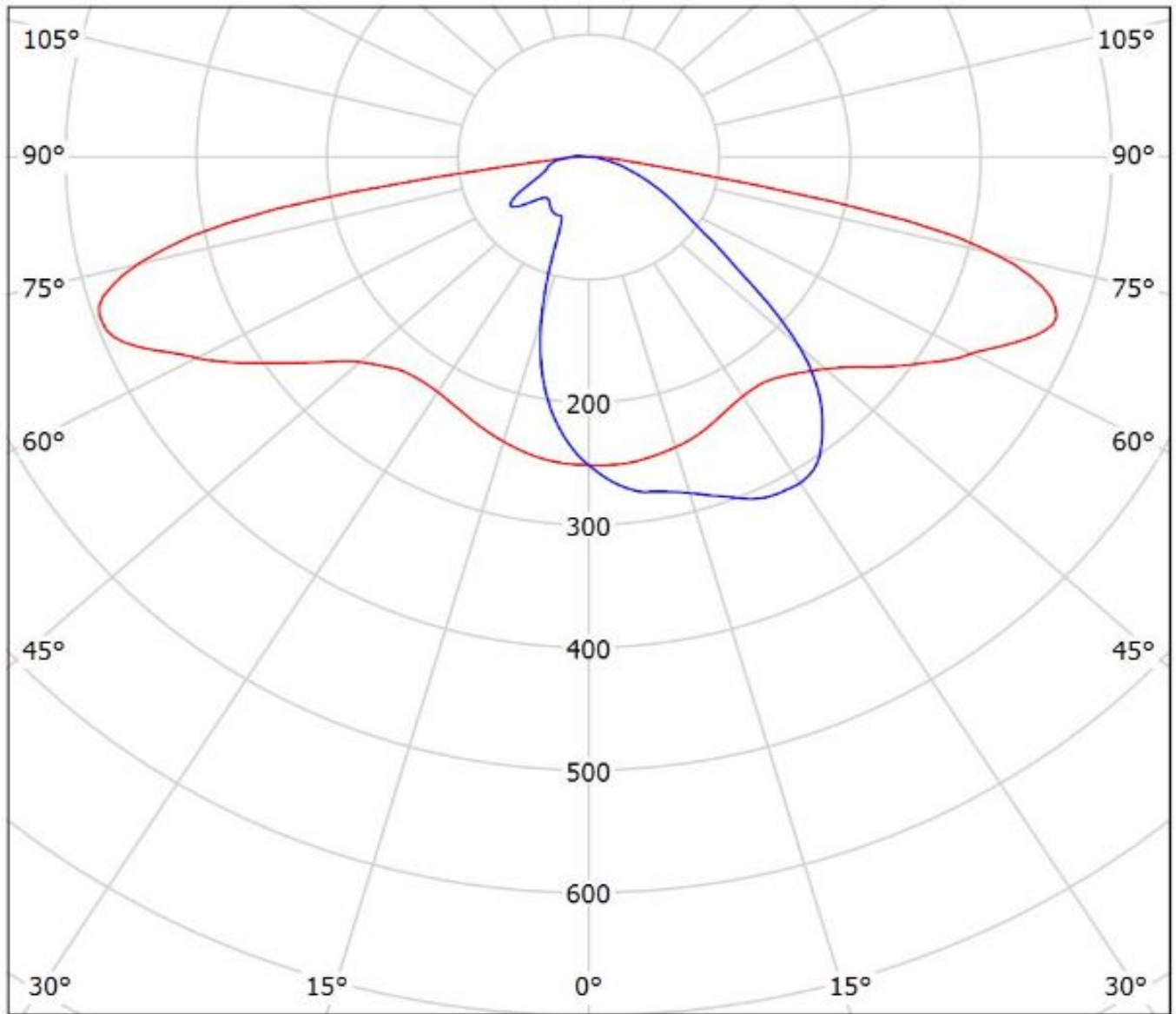

cd/klm

— C0 - C180 — C90 - C270

$\eta = 94\%$

LEDiL Oy C12362_STRADA-2x2-DWC_(MJT4040) Eff.94.0% / LDC (Polar)

Luminaire: LEDiL Oy C12362_STRADA-2x2-DWC_(MJT4040) Eff.94.0%

Lamps: 1 x SEOUL ACHRICH MJT4040 (SAW09H0A) 255.63lm@40mA P=2.37W I=40mA

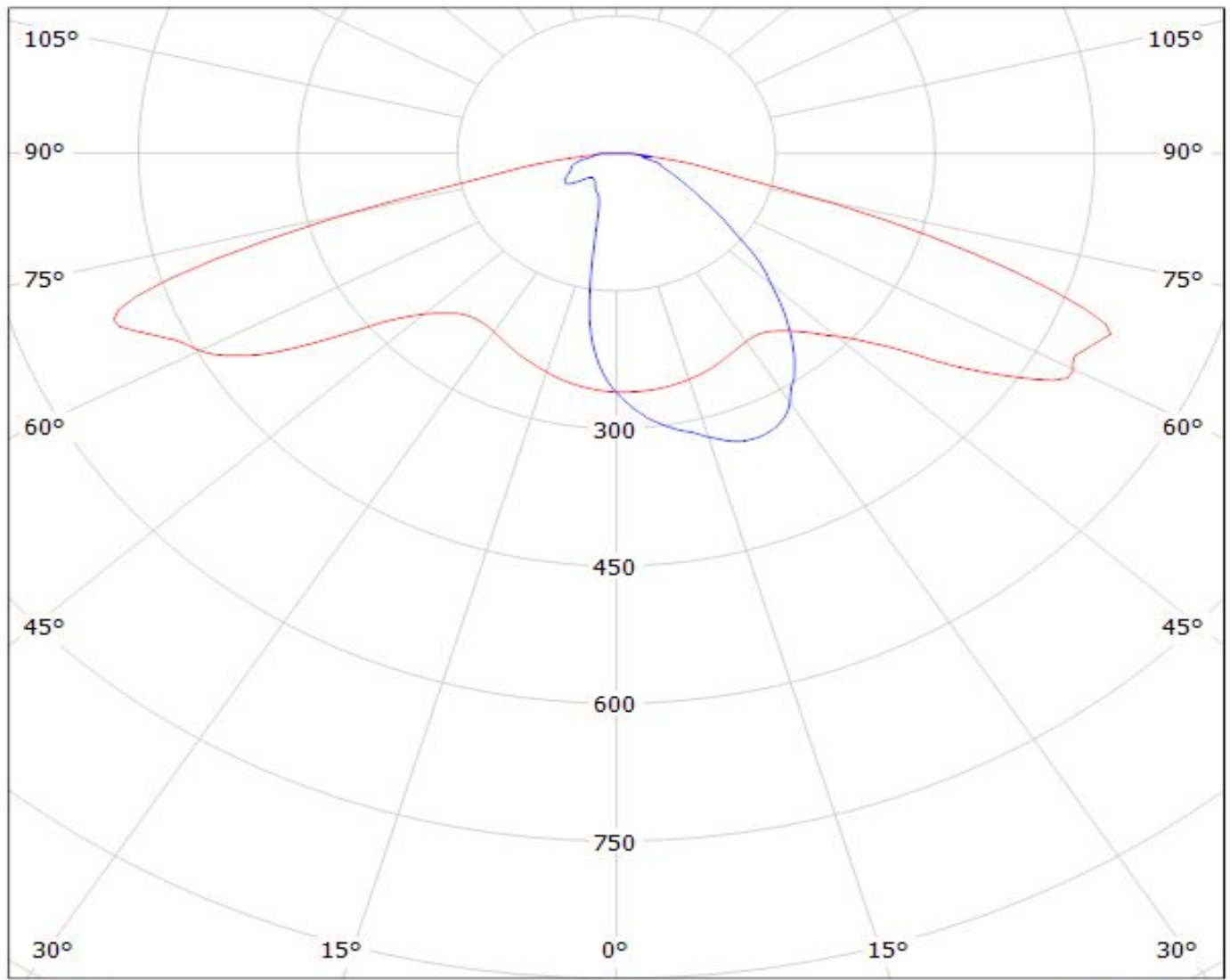

cd/klm

— C0 - C180

— C90 - C270

$\eta = 94\%$

Luminaire: LEDil Oy C12362_STRADA-2X2-DWC_(Z5M1) Efficiency=94%

Lamps: 1 x Seoul Z5M1 (SZ5-M1-WN-C8) 379lm @ 250mA CCT=4600K P=2.9W I=250mA

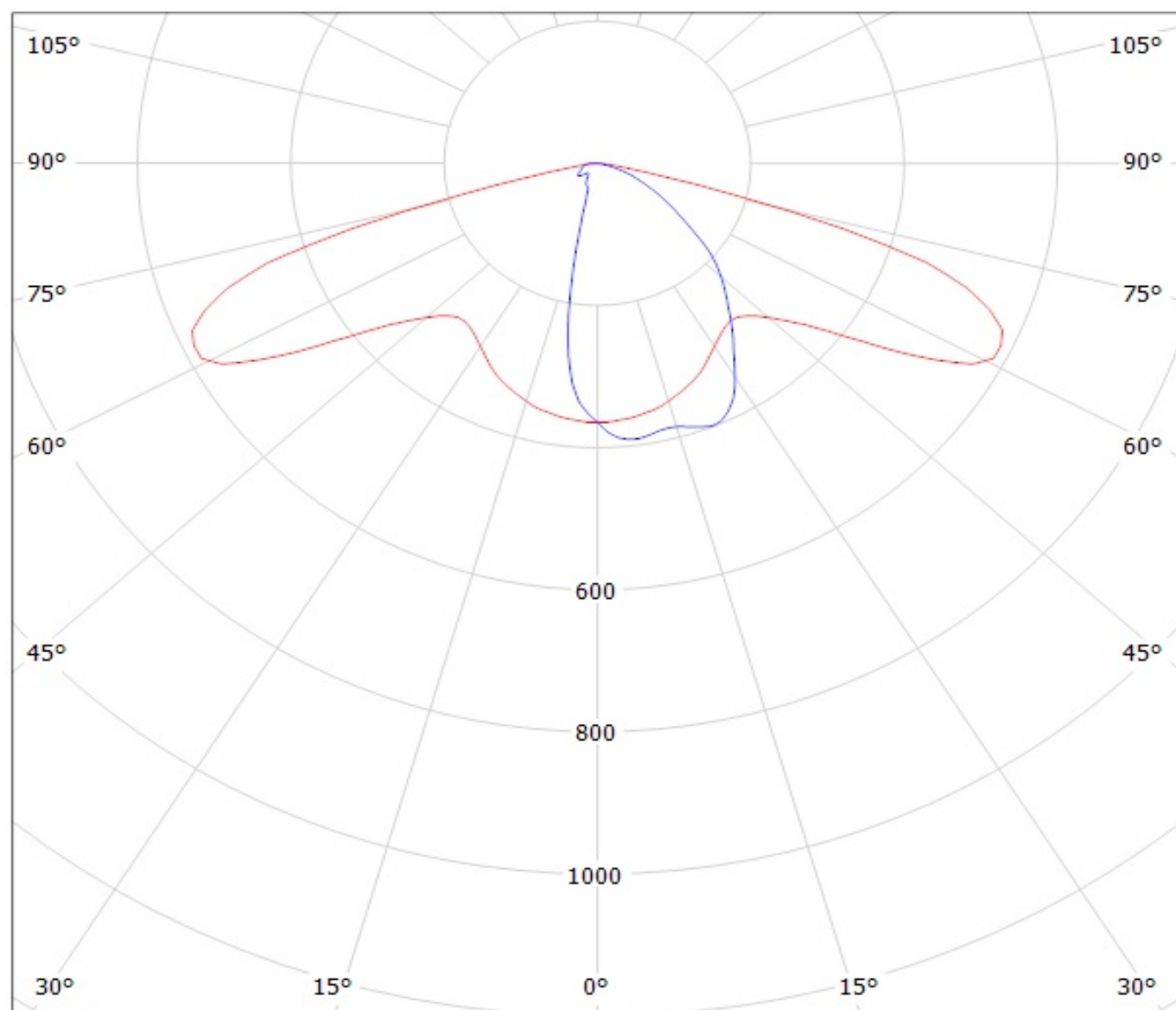

cd/klm

— C0 - C180

— C90 - C270

Luminaire: Ledil C12362_STRADA-2X2-DWC_(Z8Y22plus)

Lamps: 1 x Seoul_Z8Y22plus_(W6E2G)_513.996lm@250mA_P=2.754W_I=0.250A

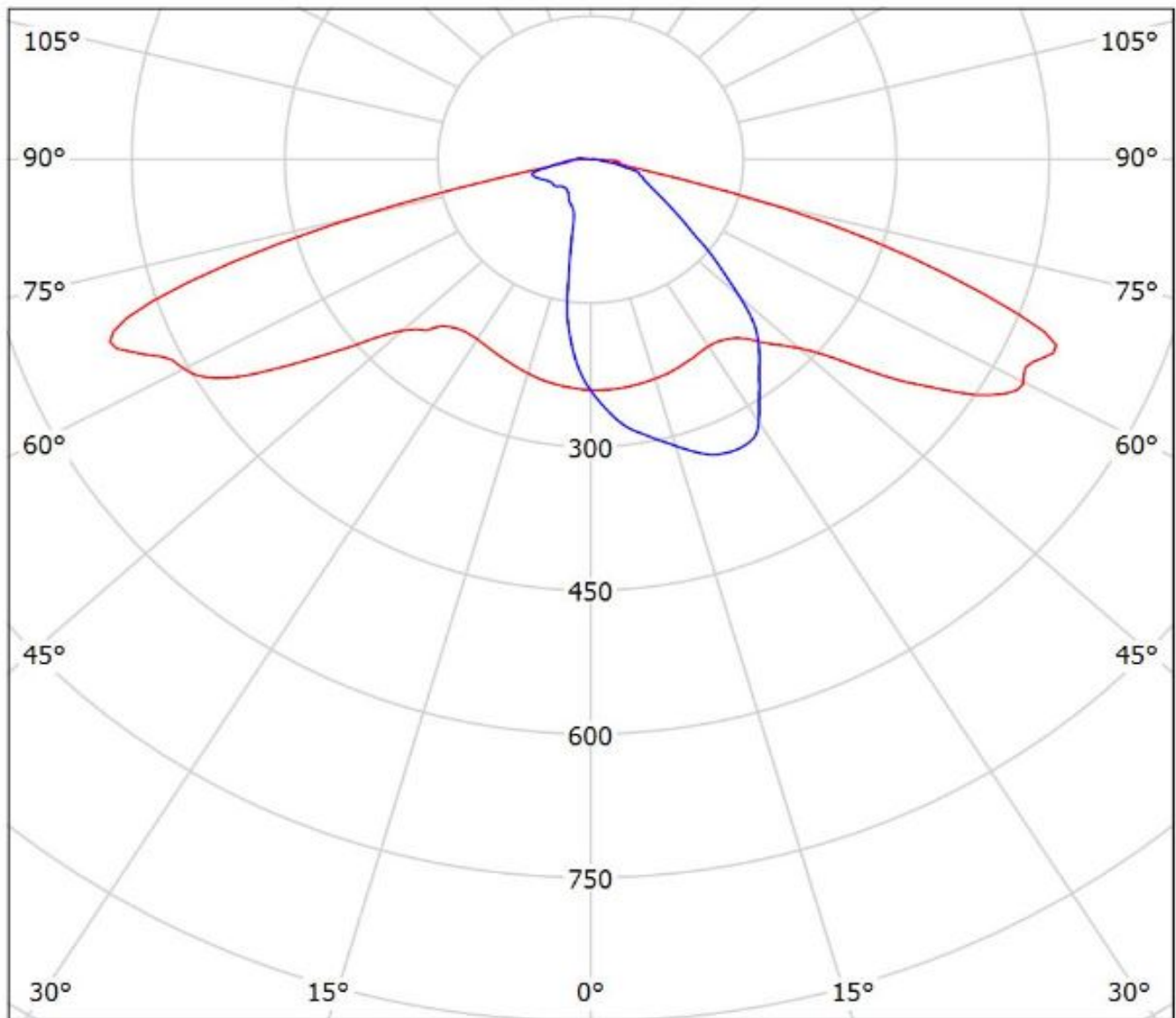

cd/klm

— C0 - C180 — C90 - C270

$\eta = 96\%$

Ledil C12362_STRADA-2X2-DWC_(TL1L4) / LDC (Polar)

Luminaire: Ledil C12362_STRADA-2X2-DWC_(TL1L4)

Lamps: 1 x Toshiba_TL1L4_2x2_(TL1L4-DW0)_472.639lm@250mA_CCT=6500K_P=2.9W_I=0.25A

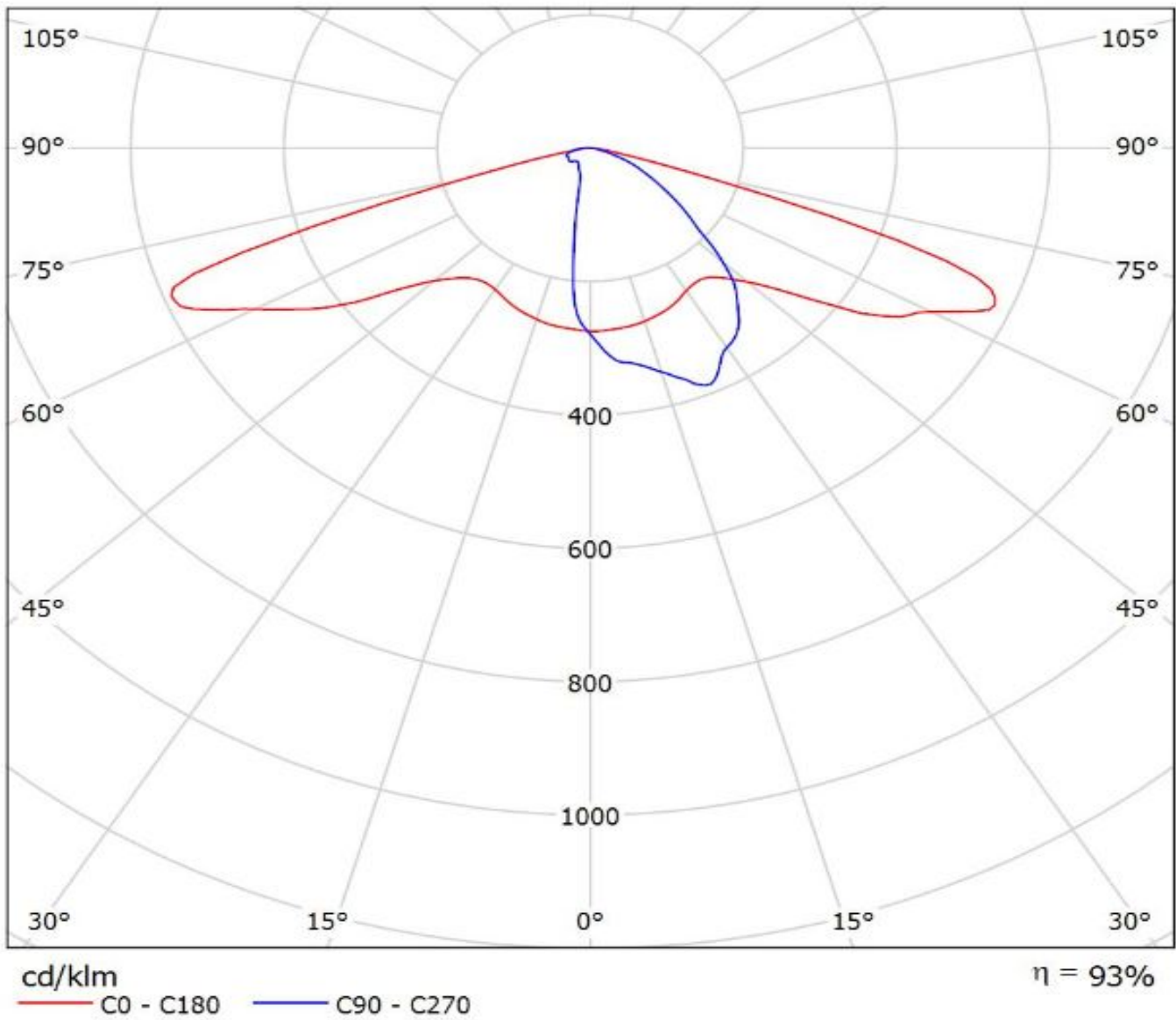

Luminaire: LEDiL Oy C12362_STRADA-2X2-DWC_(Tridonic_Module_RLE_G1)
Lamps: 1 x Tridonic_Module_RLE_G1_4576.03lm@700mA_P=32.0681W_I=0.700A

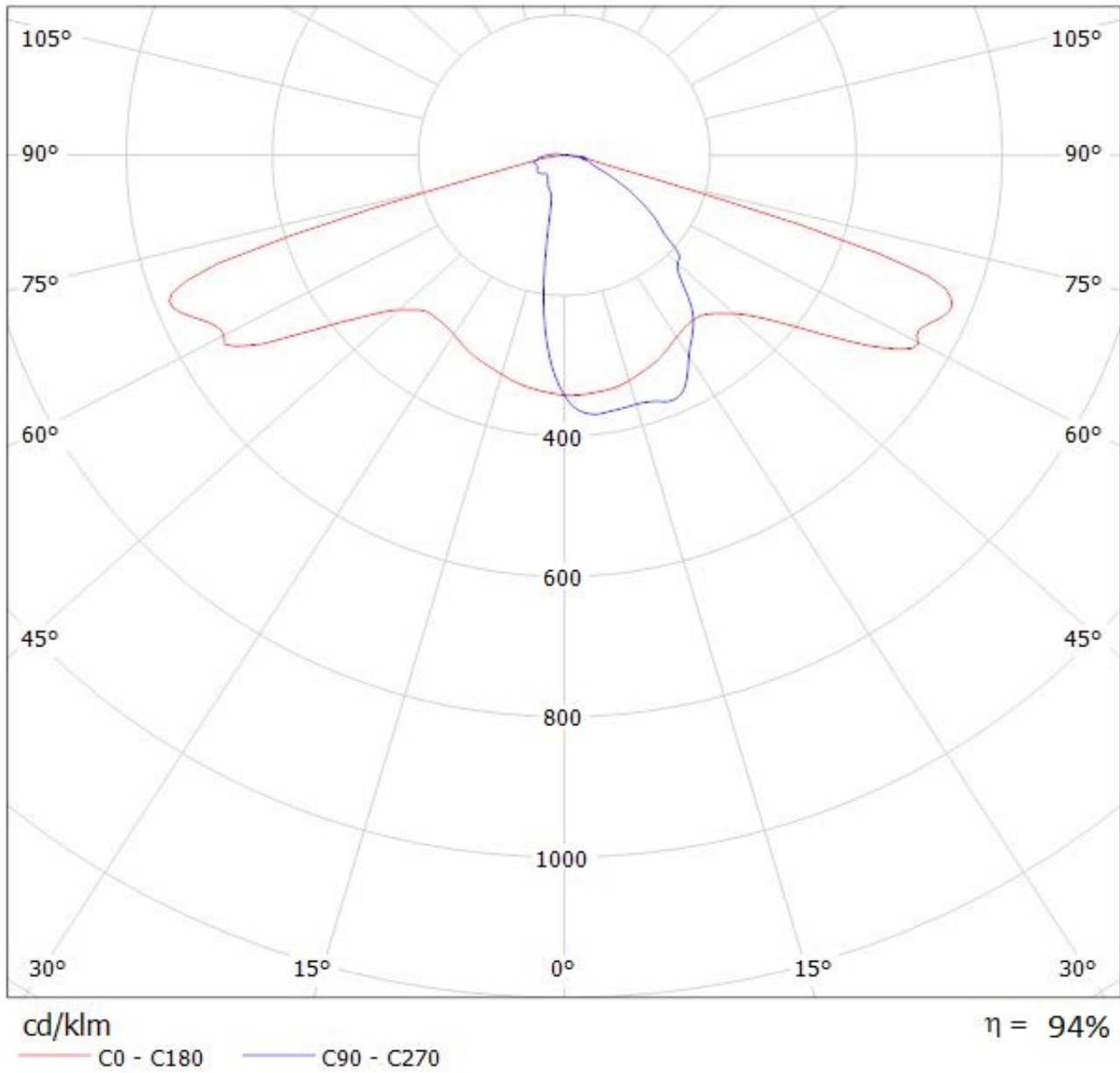

Luminaire: LEDiL Oy C12362_STRADA-2X2-DWC_(Tridonic_Module_RLE_G1)
Lamps: 1 x Tridonic_Module_RLE_G1_4576.03lm@700mA_P=32.0681W_I=0.700A

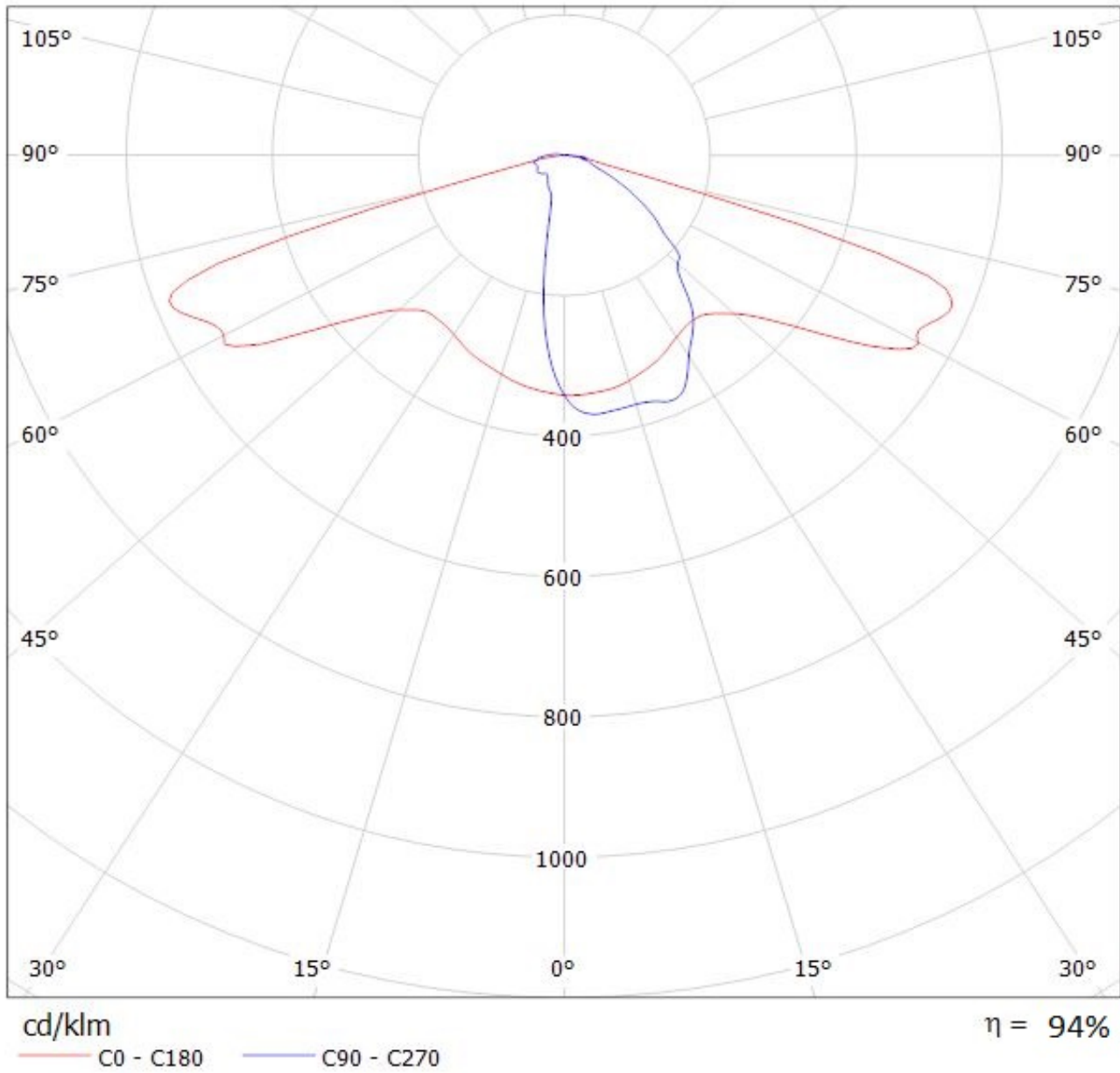

Luminaire: LEDiL Oy C12362_STRADA-2X2-DWC_(Tridonic_Module_RLE_G1)
Lamps: 1 x Tridonic_Module_RLE_G1_2288lm@700mA_P=16W_I=0.700A

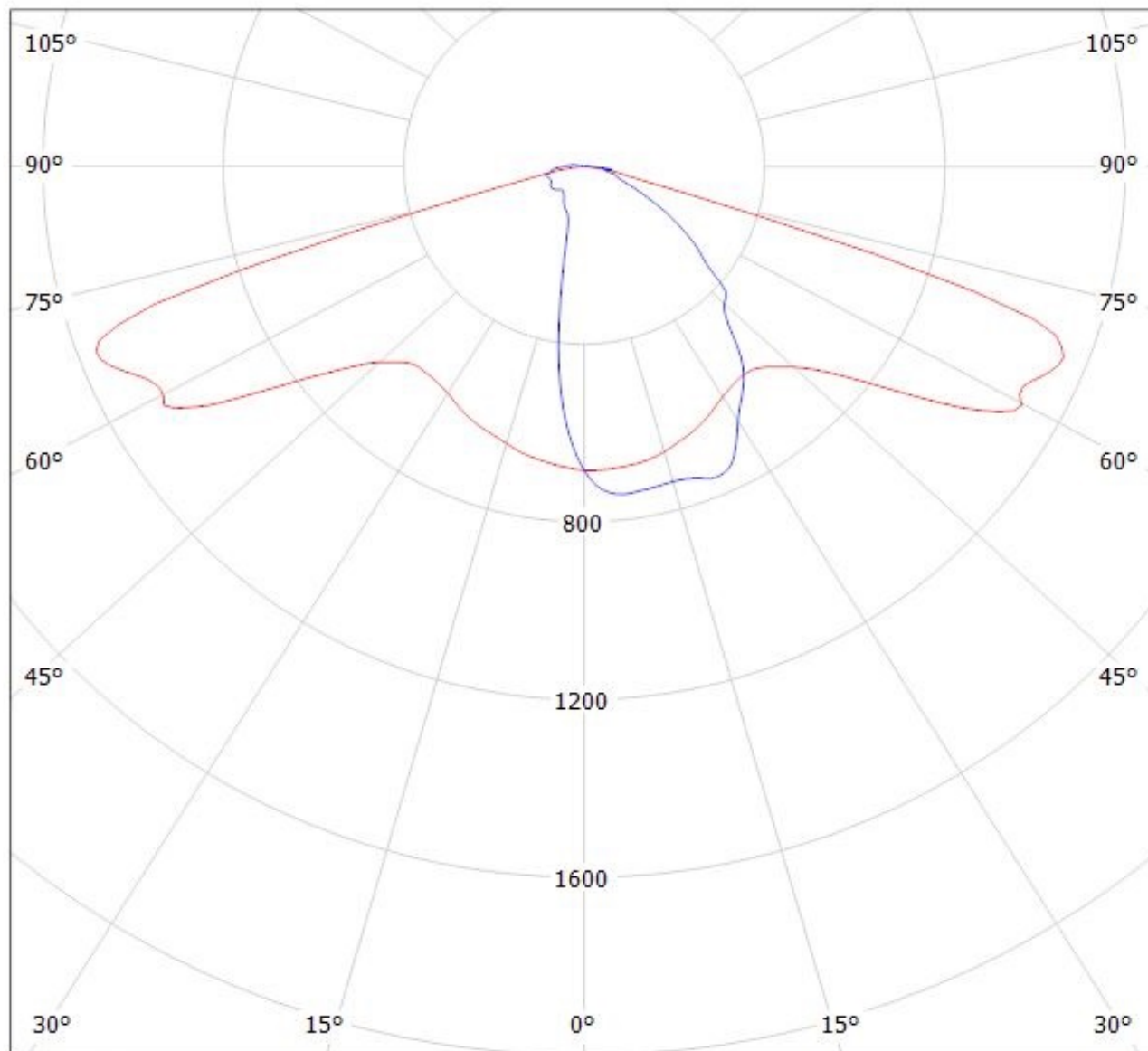

cd/klm

— C0 - C180

— C90 - C270

$\eta = 94\%$

Luminaire: LEDiL Oy C12362_STRADA-2X2-DWC_(Tridonic_Module_RLE_G1)
Lamps: 1 x Tridonic_Module_RLE_G1_2288lm@700mA_P=16W_I=0.700A

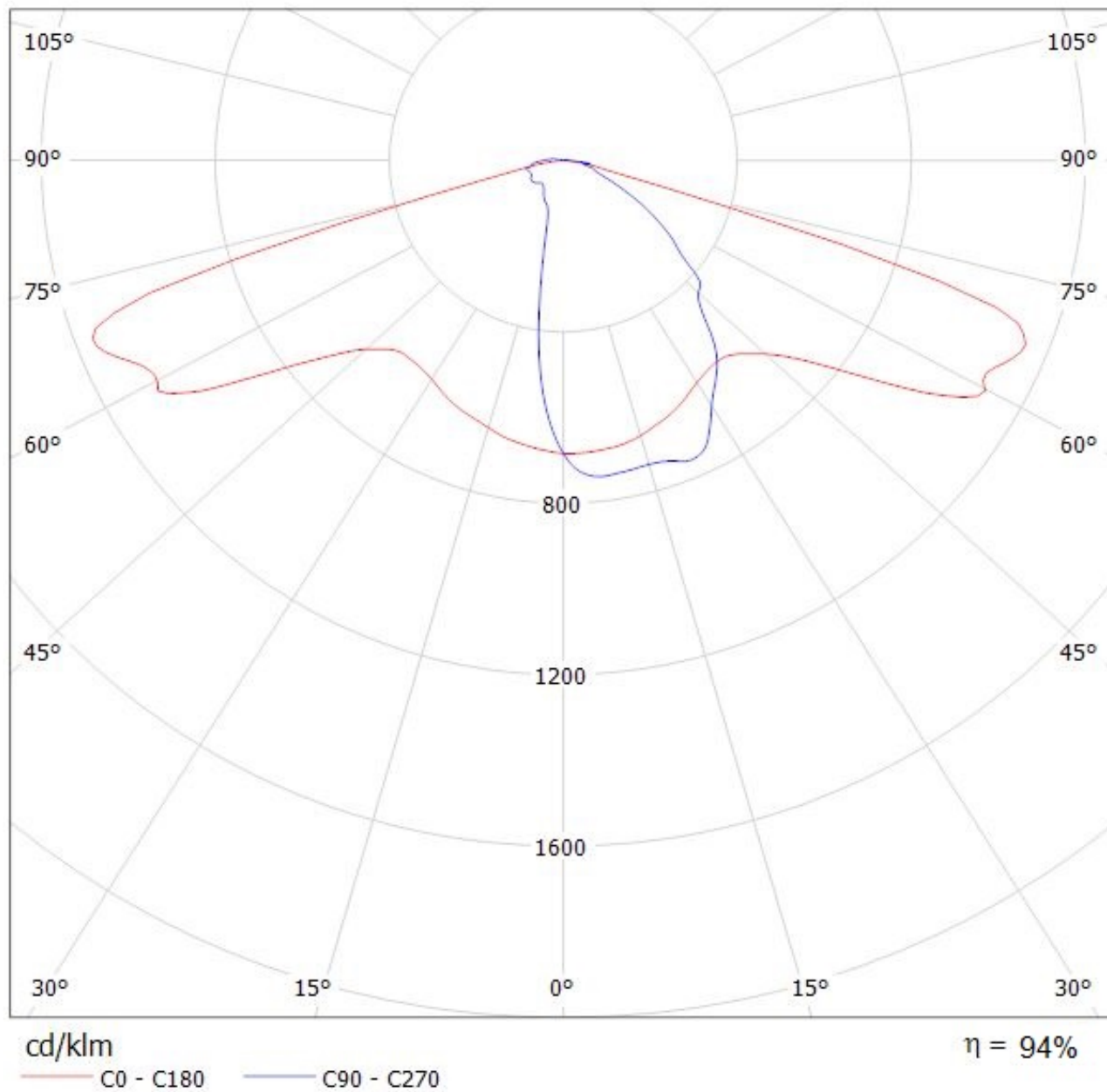

NOTE: The typical divergence will be changed by different color, chip size and chip position tolerance. The typical total divergence is the full angle measured where the luminous intensity is half of the peak value.