

FLORENCE-1R-O

~95° + 30° oval beam

TECHNICAL SPECIFICATIONS:

Dimensions	285.6 x 19.5 mm
Height	7 mm
Fastening	glue, clips
Colour	clear
Box size	480 x 280 x 300 mm
Box weight	7.1 kg
Quantity in Box	210 pcs
ROHS compliant	yes ⓘ

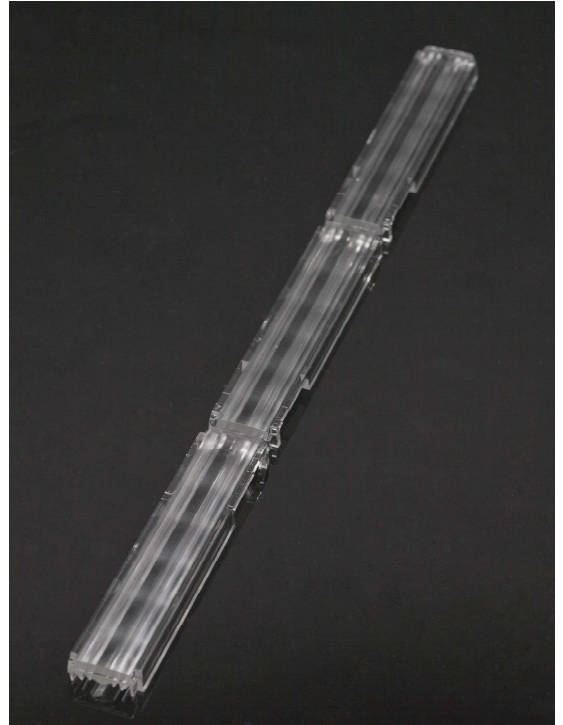

MATERIAL SPECIFICATIONS:

Component	Type	Material	Colour
FLORENCE-1R-O	Linear lens	PMMA	clear

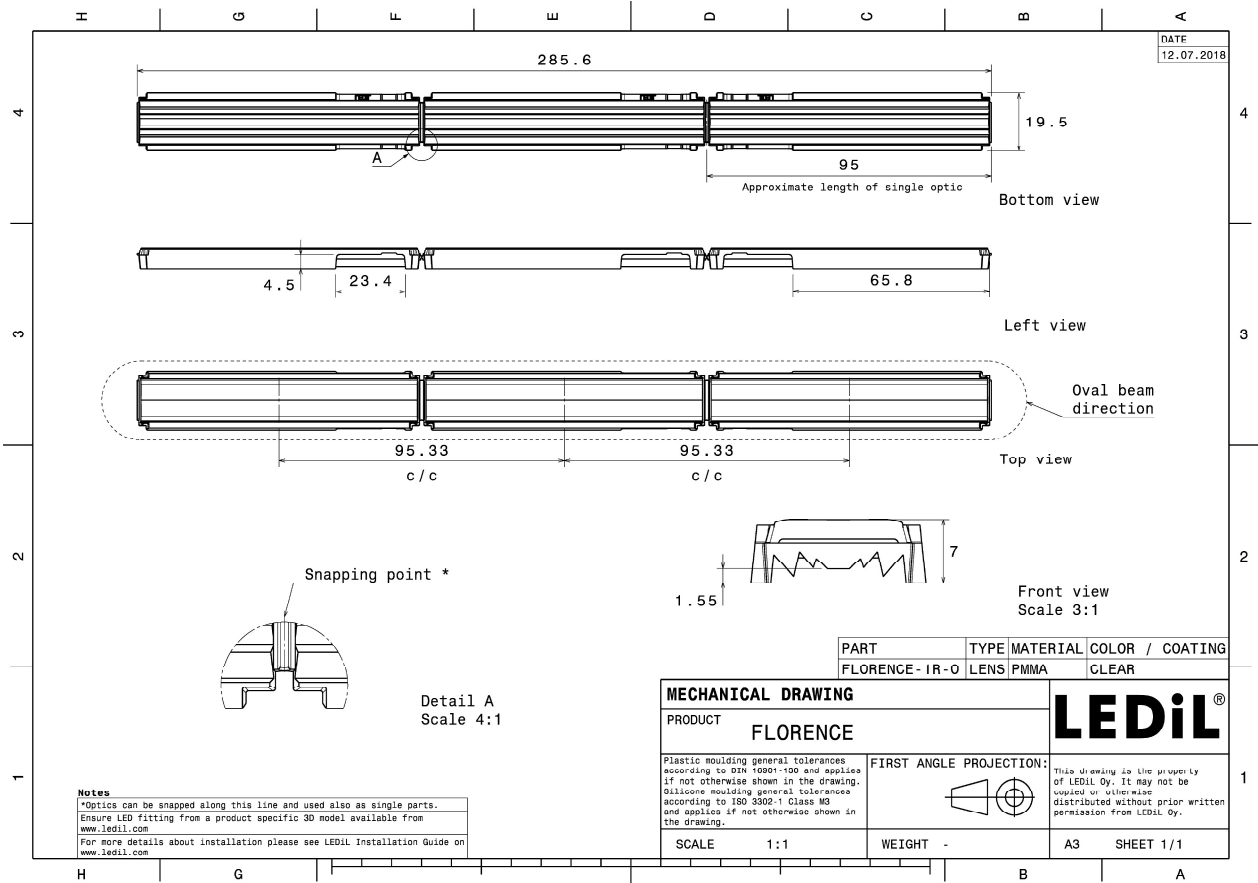

PHOTOMETRIC DATA (MEASURED):

CEZOS

LED L0-280024-xxx-C0800-L267
 FWHM 92.0 + 35.0°
 Efficiency 91 %
 Peak intensity 0.780 cd/lm
 LEDs/each optic 1
 Light colour White
 Required components:

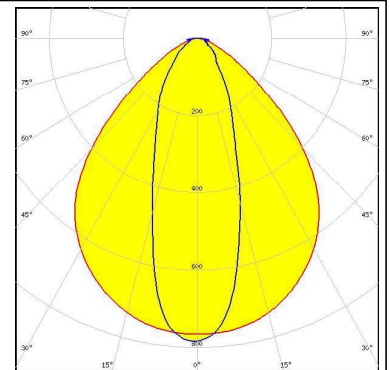
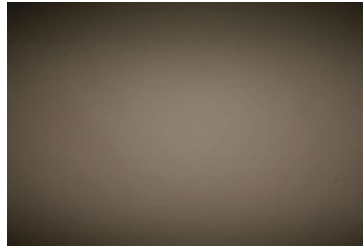

LUMILEDS

LED LUXEON 3014
 FWHM 98.0 + 33.0°
 Efficiency 93 %
 Peak intensity 1.030 cd/lm
 LEDs/each optic 1
 Light colour White
 Required components:

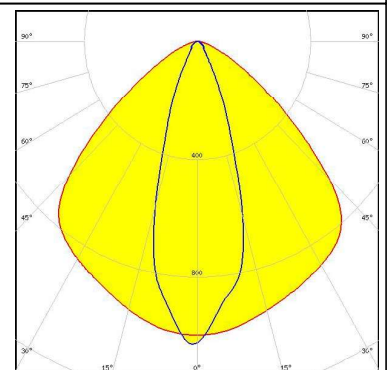
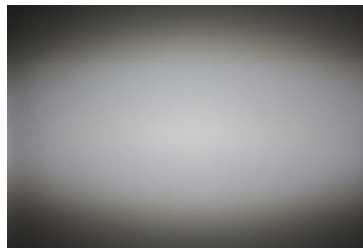

LUMILEDS

LED LUXEON 3020
 FWHM 95.0 + 31.0°
 Efficiency 93 %
 Peak intensity 1.060 cd/lm
 LEDs/each optic 1
 Light colour White
 Required components:

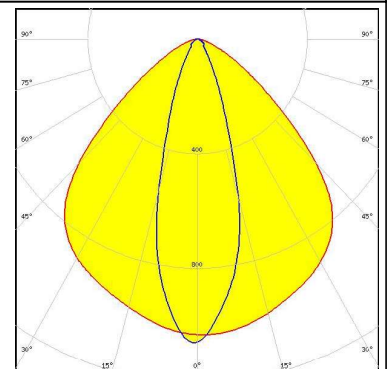
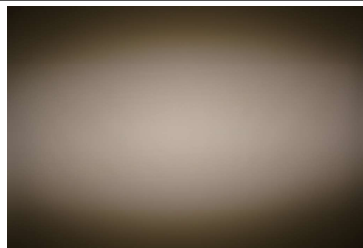

LUMILEDS

LED LUXEON 3030 2D (Round LES)
 FWHM 93.0 + 34.0°
 Efficiency 91 %
 Peak intensity 0.890 cd/lm
 LEDs/each optic 1
 Light colour White
 Required components:

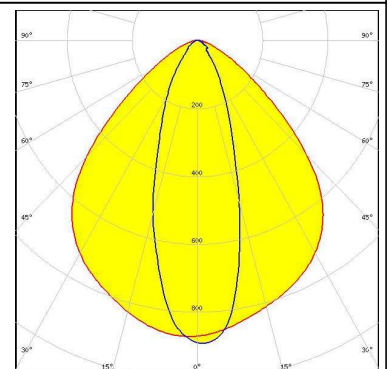
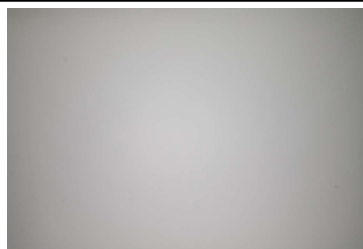

PHOTOMETRIC DATA (MEASURED):

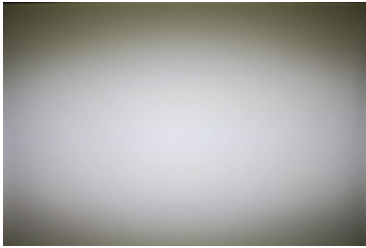
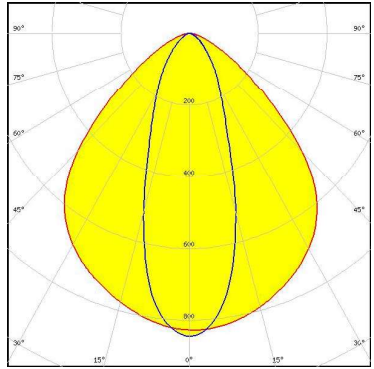
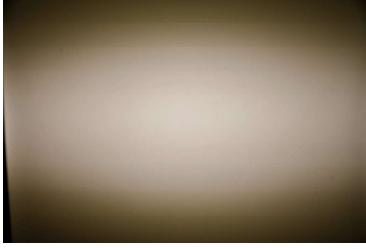
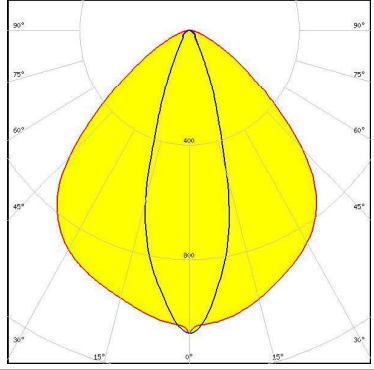
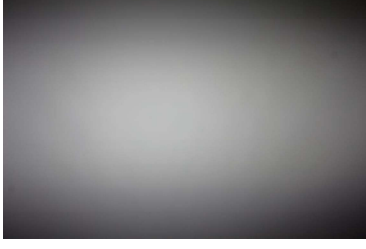
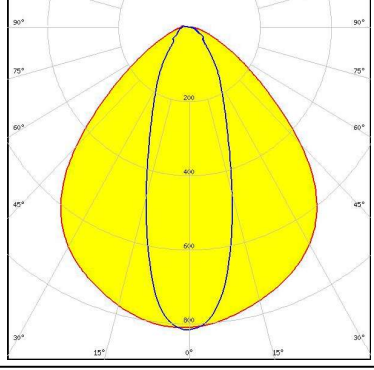
<p>LUMILEDS</p> <p>LED LUXEON 3535L FWHM 93.0 + 35.0° Efficiency 93 % Peak intensity 0.850 cd/lm LEDs/each optic 1 Light colour White Required components:</p>		
<p>LUMINUS</p> <p>LED MP-2016 FWHM 94.0 + 31.0° Efficiency 92 % Peak intensity 1.100 cd/lm LEDs/each optic 1 Light colour White Required components:</p>		
<p>NICHIA</p> <p>LED NF2x757D FWHM 93.0 + 34.0° Efficiency 94 % Peak intensity 0.820 cd/lm LEDs/each optic 1 Light colour White Required components:</p>		
<p>NICHIA</p> <p>LED NF2x757G FWHM 92.0 + 35.0° Efficiency 90 % Peak intensity 0.870 cd/lm LEDs/each optic 1 Light colour White Required components:</p>	