

DETAILS

Product Number	C10686_EVA-W
Family	Eva
Type	Lens
Color	clear
Diameter	35 mm
Height	16,4 mm
Style	round
Optic Material	PMMA
Holder Material	
Fastening	
Status	production ready
ROHS Compliant	Yes
Date Updated	12/09/2013

OPTICAL PROPERTIES

LED	Viewing	Light	Efficiency	cd/lm	Connector
	Angle	Beam			
MC-E	36 deg	Wide	91 %	1.000	-
XM-L	40 deg	Wide	79 %	-	-
XM-L HVW	sim: 38	Wide	86 %	-	-
XT-E	32 deg	Wide	-	1.800	-
MK-R	48 deg	Wide	-	1.150	-
XP-G2	32 deg	Wide	81 %	2.200	-
MHB-A	39 deg	Wide	78 %	1.670	-
XHP35 HI	57 deg	Wide	75 %	0.810	-
LUXEON M	45 deg	Wide	80 %	1.300	-
LUXEON MZ	36 deg	Wide	81 %	1.900	-
LUXEON 5258	sim: 34	Wide	sim: 87 %	sim: 1.900	-
LUXEON 5050	37 deg	Wide	83 %	1.700	-
NS9x383	39 deg	Wide	81 %	1.600	-
NSMx286M	41 deg	Wide	80 %	1.430	-
Duris S8	39 deg	Wide	81 %	1.800	-
Duris P10	sim: 41	Wide	sim: 87 %	sim: 1.600	-
Z8Y15	29 deg	Wide	80 %	2.310	-
Z8Y19	30 deg	Wide	81 %	2.340	-



Relative intensity of C10686_EVA-W-(XPG2)

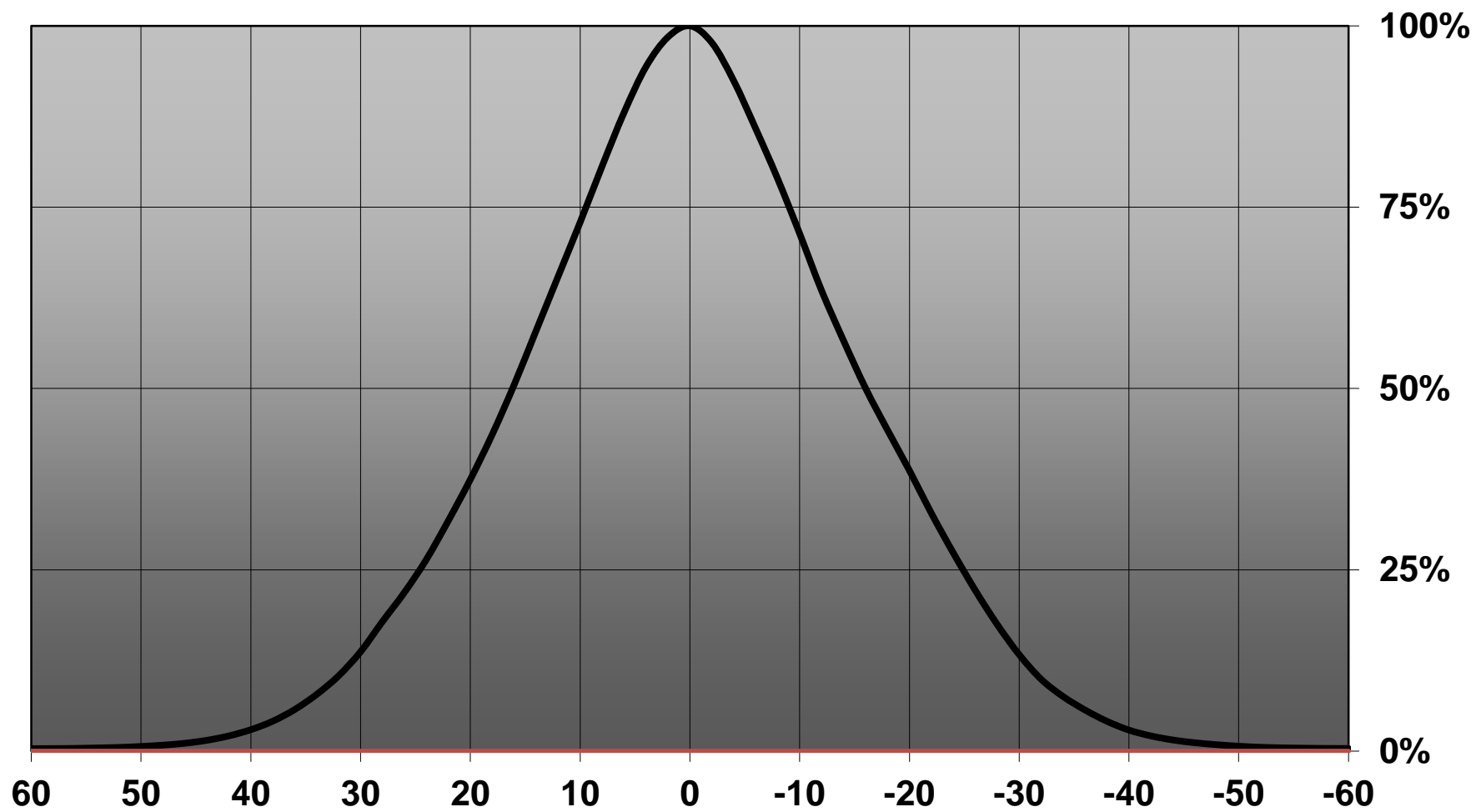

Relative intensity of C10686_EVA-W_(MH-B)

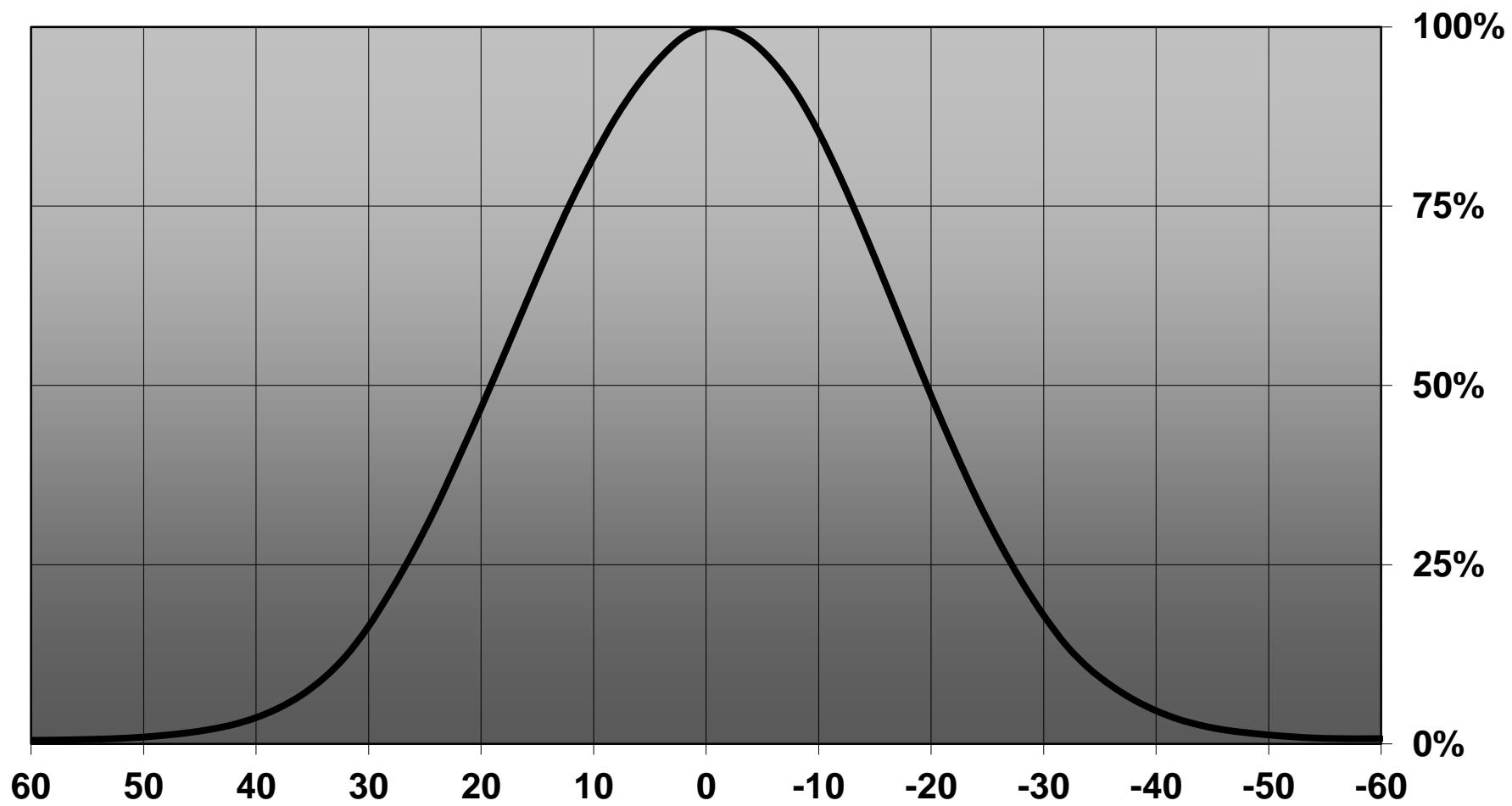

Relative intensity of C10686_EVA-W_(XHP35_HI)

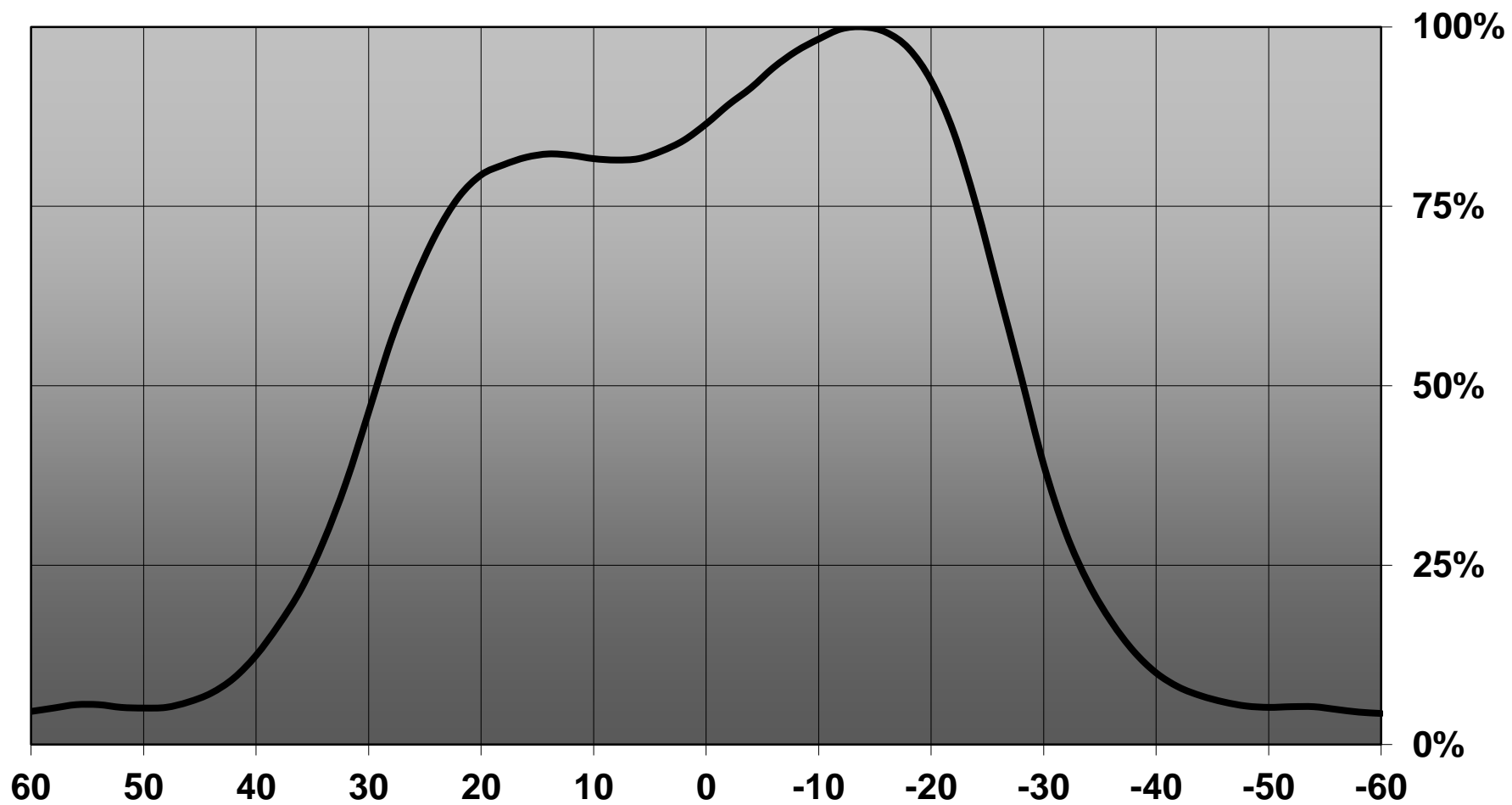

Relative intensity of C10686_EVA-W_(SZ8Y15)

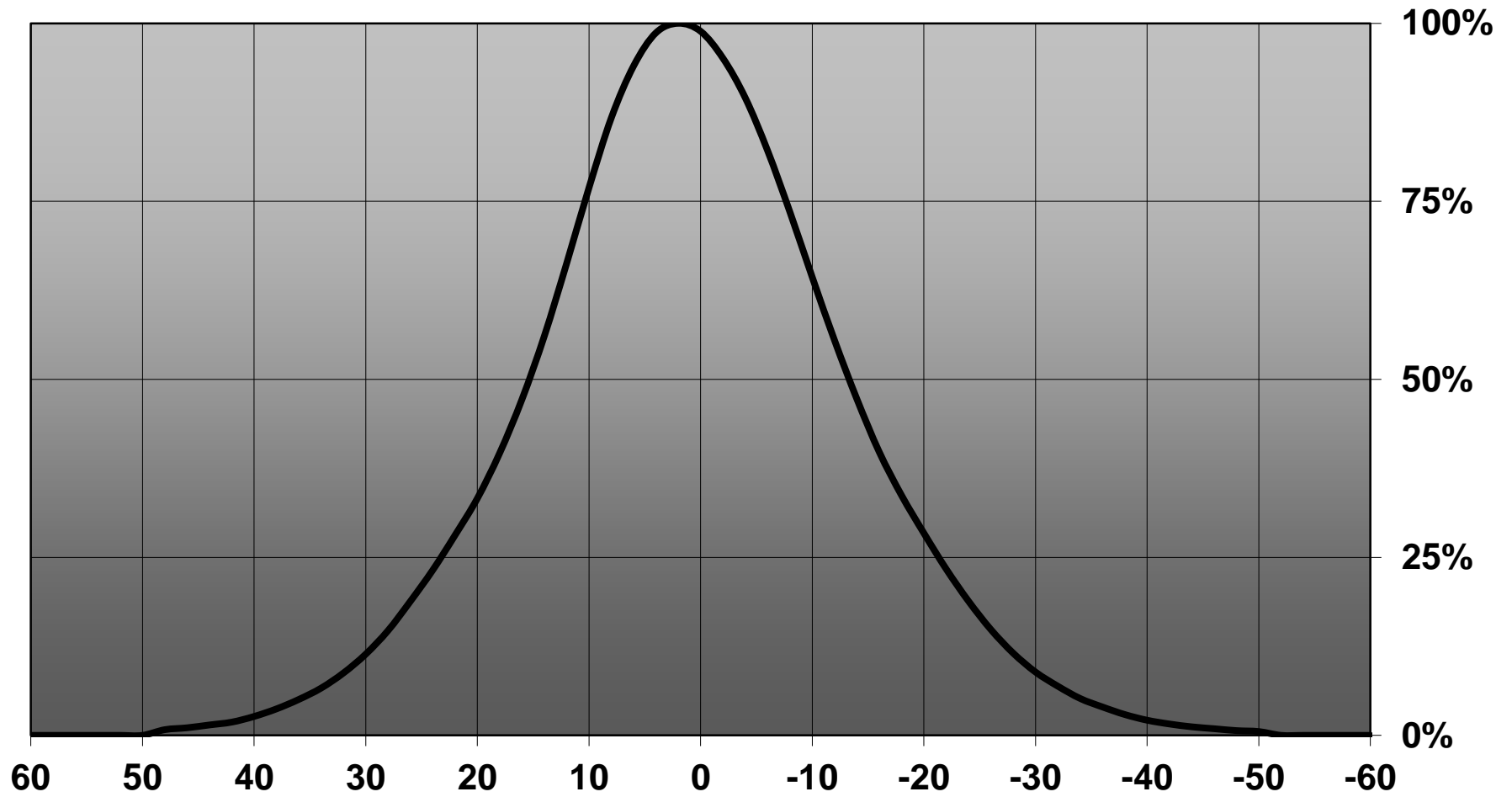

Relative intensity of C10686_EVA-W_(SZ8Y19)

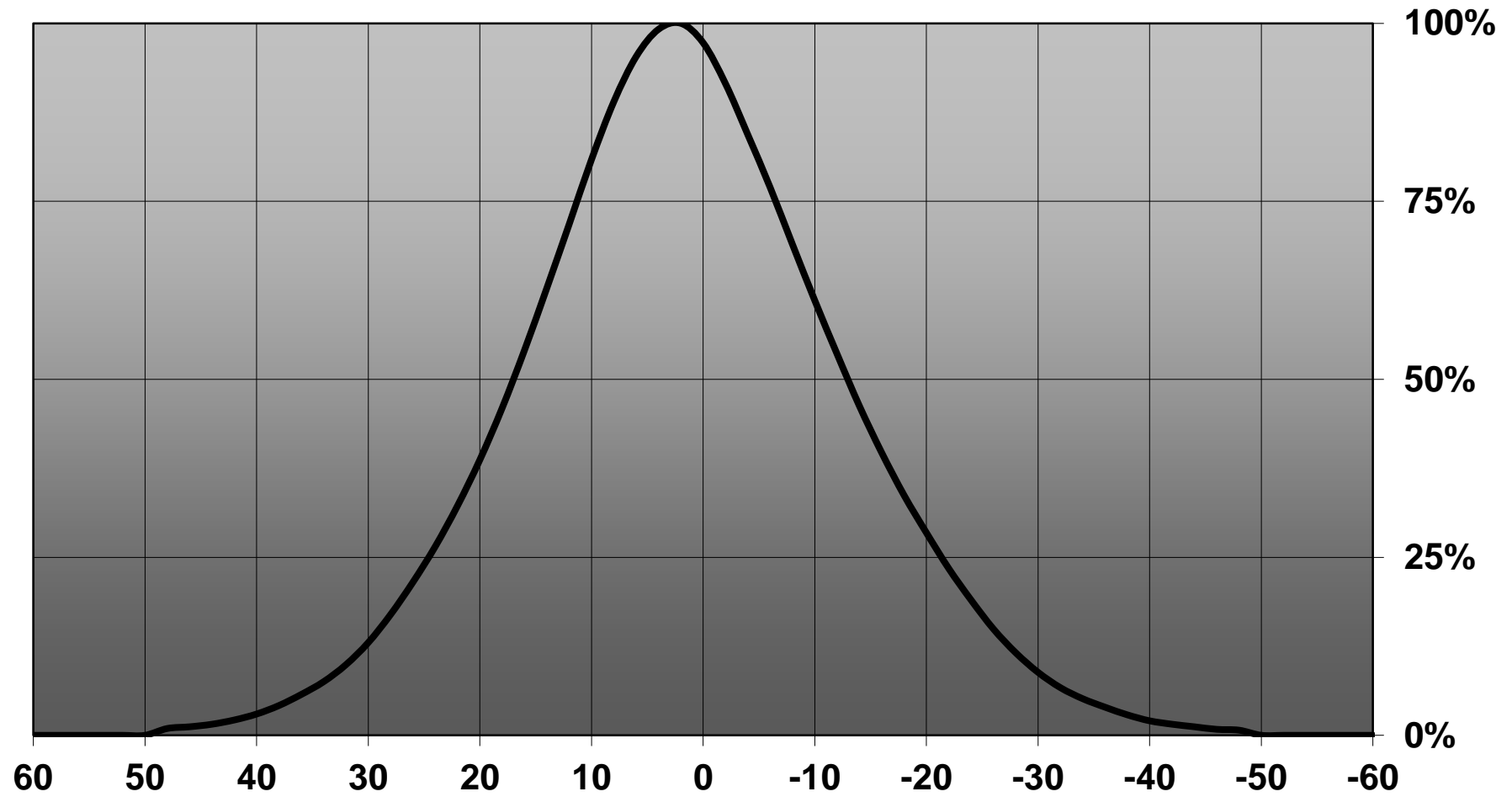

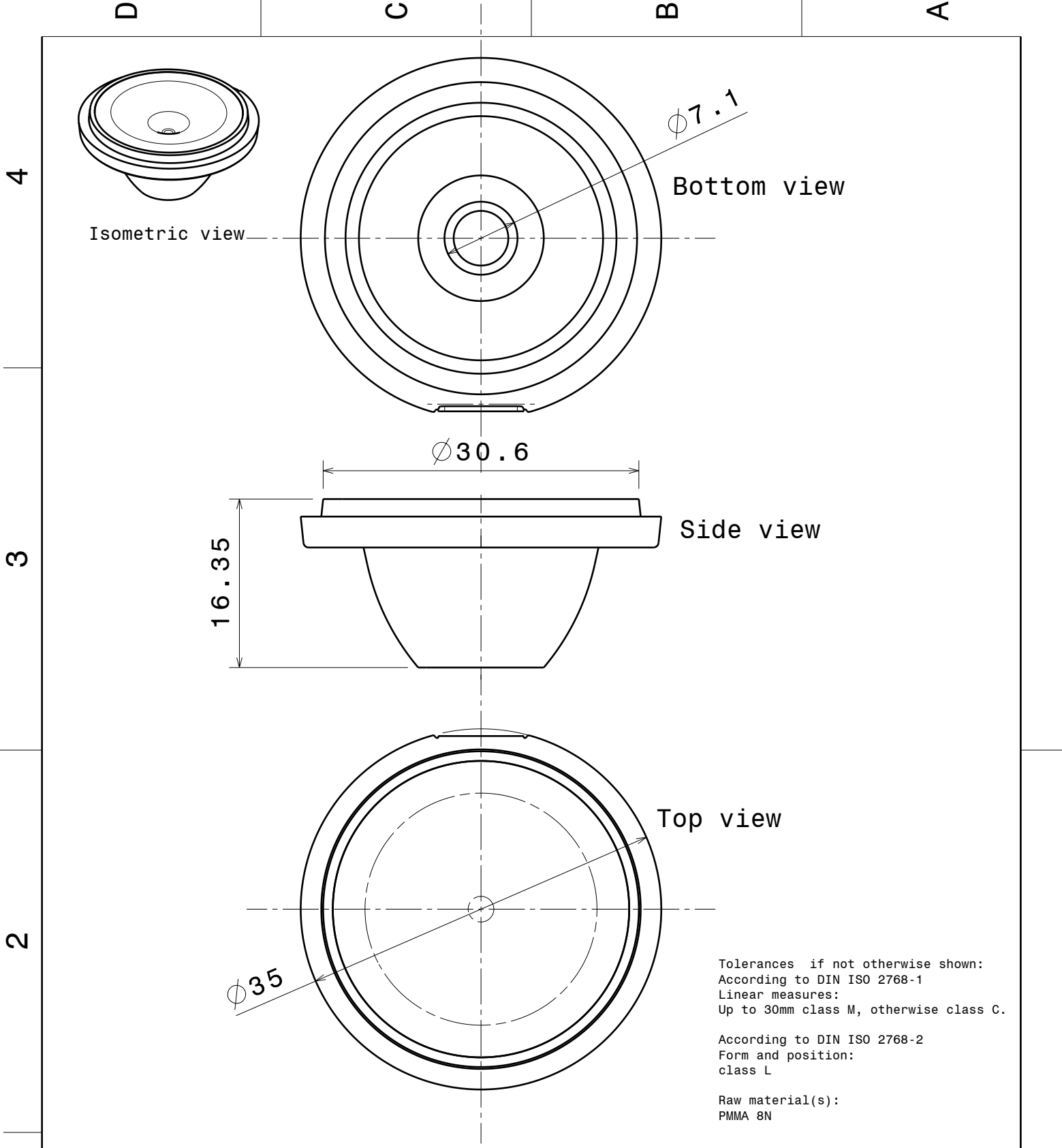

This drawing is our property.
 It can't be reproduced
 or communicated without
 our written agreement.



Ledil Oy
 Salorankatu 10
 24100 SALO
 Finland

DRAWING TITLE

Datasheet Eva Wide Lens

DRAWN BY
ah

DATE
28.2.2013

CHECKED BY

DATE

SIZE
A4

DRAWING NUMBER

10686

REV
2.0

DESIGNED BY
hh

DATE
26.08.2008

SCALE

2:1

WEIGHT (g)

SHEET

1/1

Ledil Oy C10686_Eva-MC-W C10686_Eva-MC-W / LDC (Linear)

Luminaire: Ledil Oy C10686_Eva-MC-W C10686_Eva-MC-W
Lamps: 1 x Cree MC-E (white)

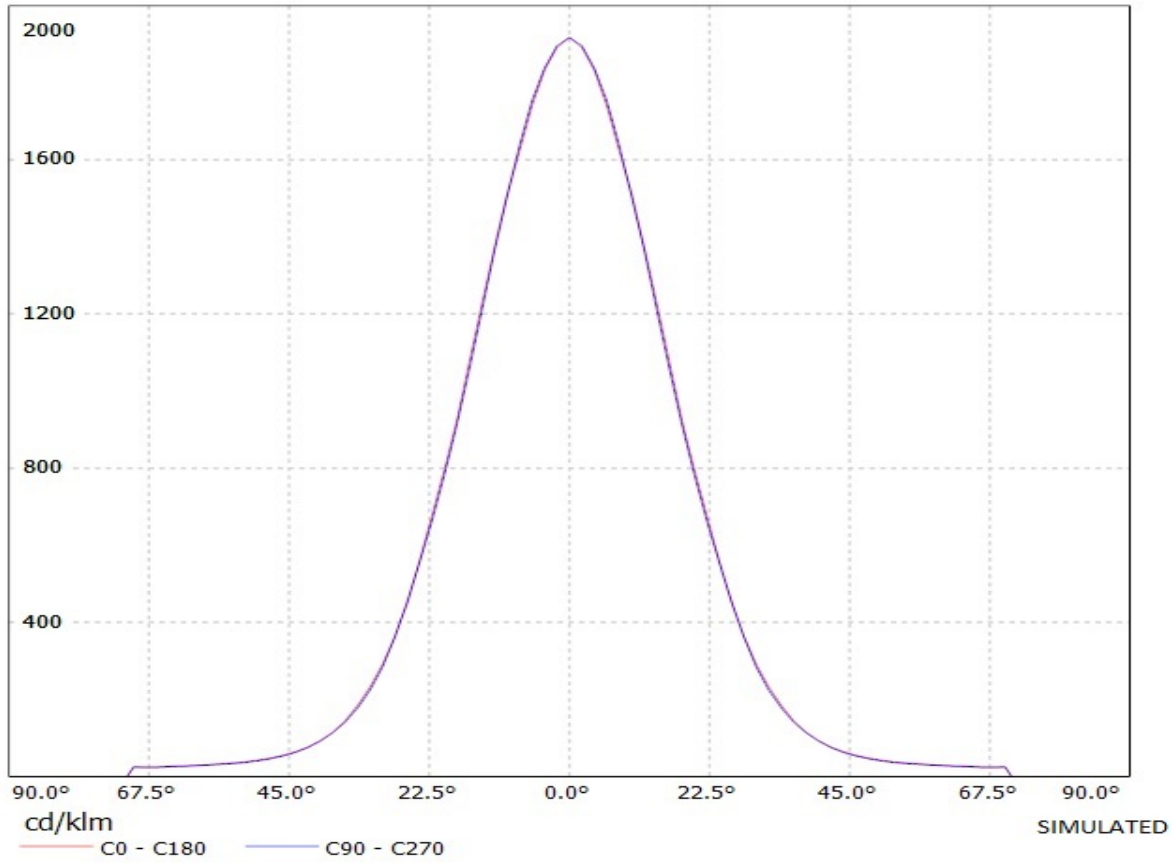

Luminaire: LEDiL Oy C10686_EVA-W_(MK-R) Eff. 79,8%
Lamps: 1 x Cree MK-R (356lm@250mA)

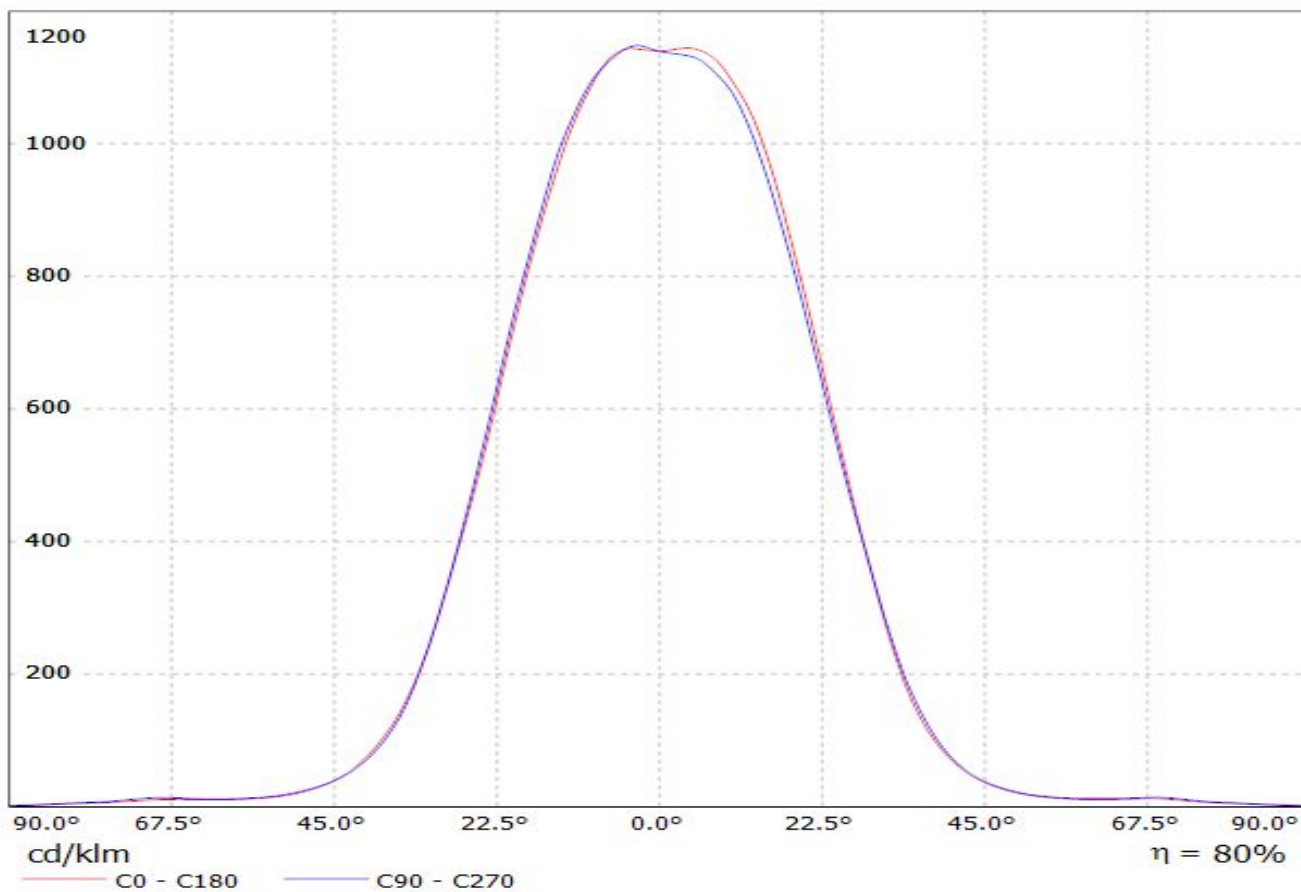

Luminaire: Ledil C10686_EVA-W (Luxeon M) Efficiency=80%
Lamps: 1 x Luxeon M (362lm @ 250mA)

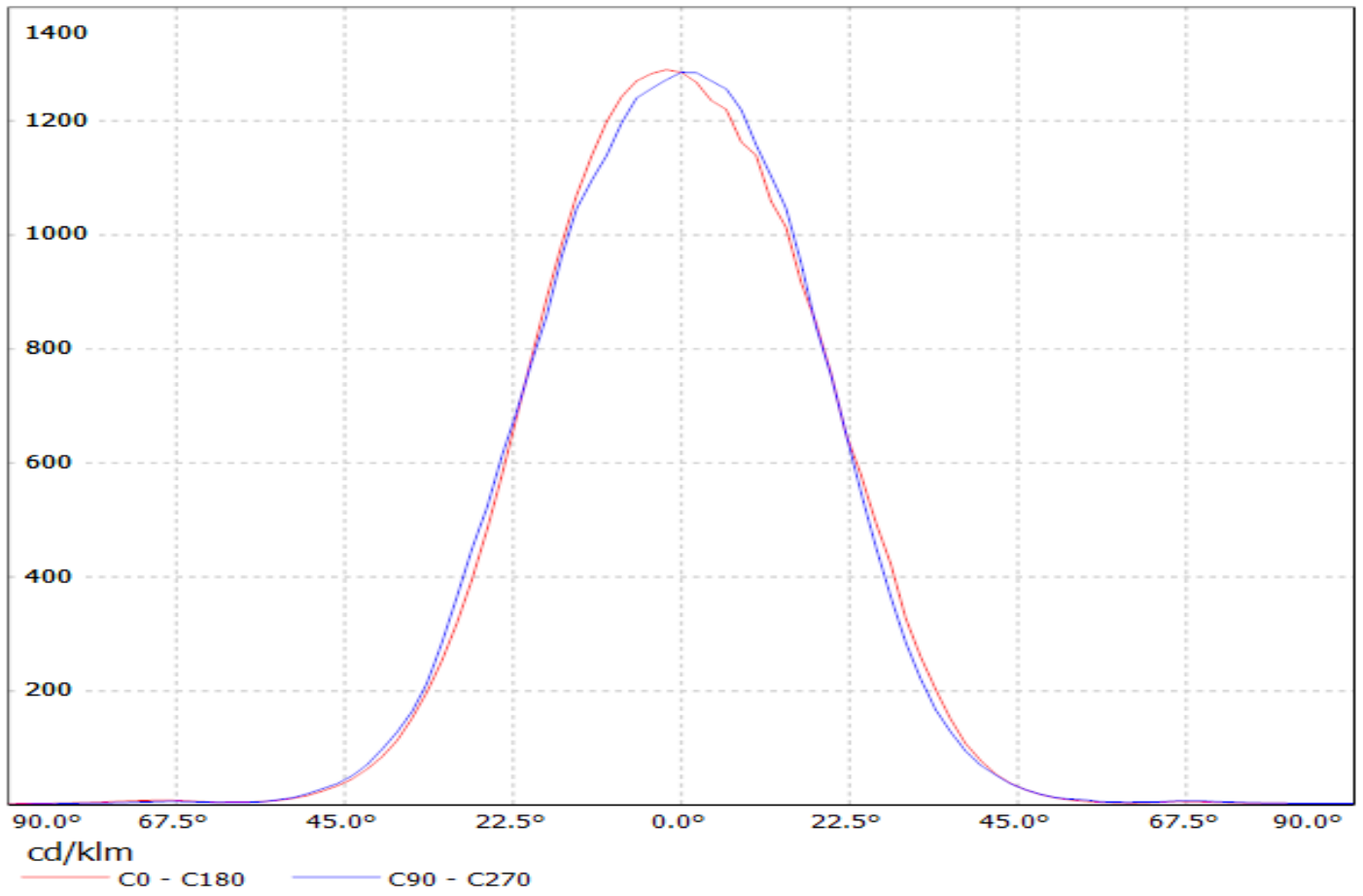

Luminaire: LEDil OY C10686_EVA-W_(Luxeon_MZ) Efficiency=81%
Lamps: 1 x Philips Lumileds Luxeon MZ (389lm @ 250mA) CCT=3800K P=2.8W I=250mA

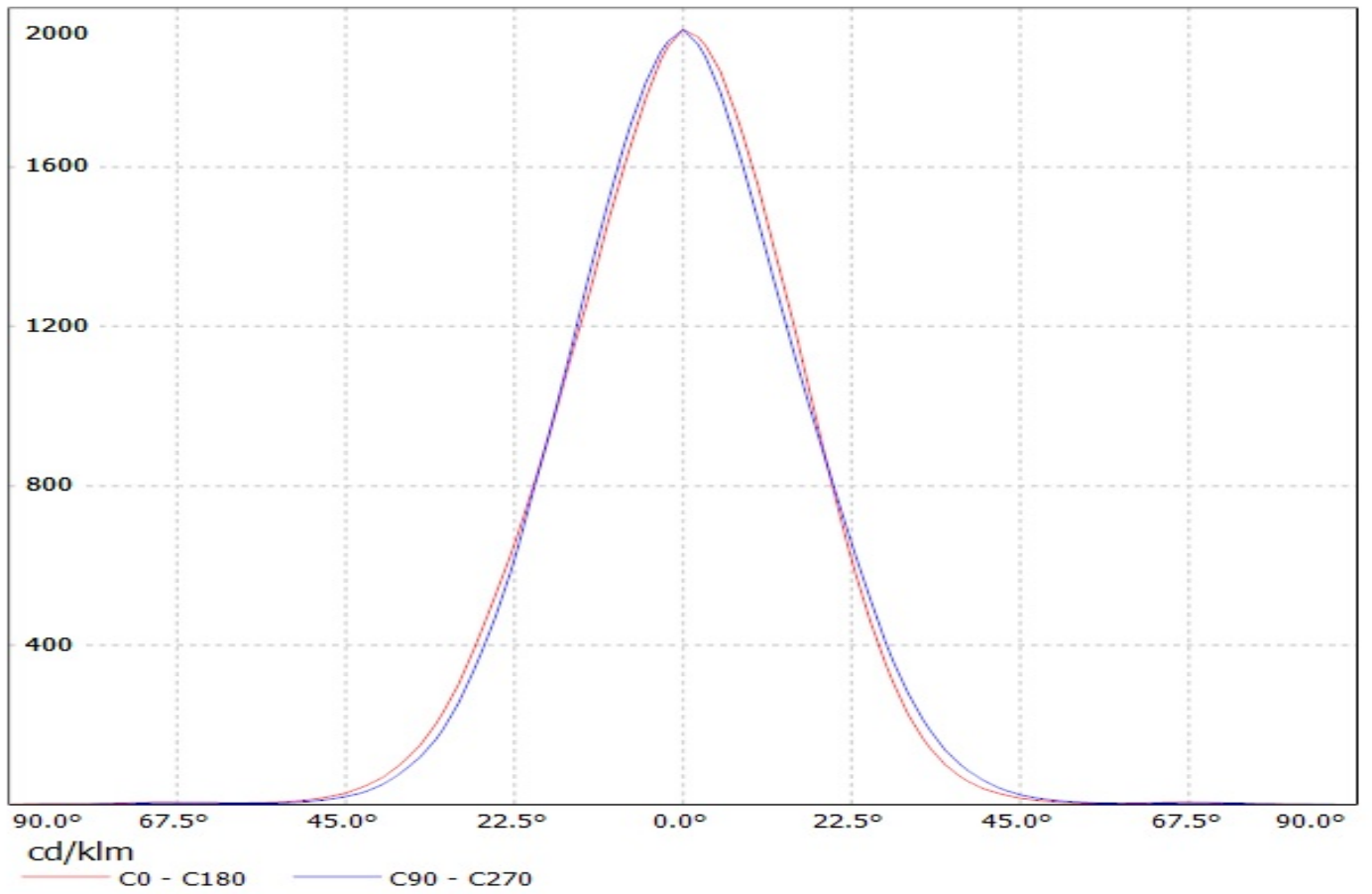

Luminaire: LEDiL Oy C10686_EVA-W_(Luxeon_5050)_(Luxeon_5050)
Lamps: 1 x Luxeon_5050_316.623lm@80mA_CCT=5700K_P=1.82294W_I=0.080A_70CRI

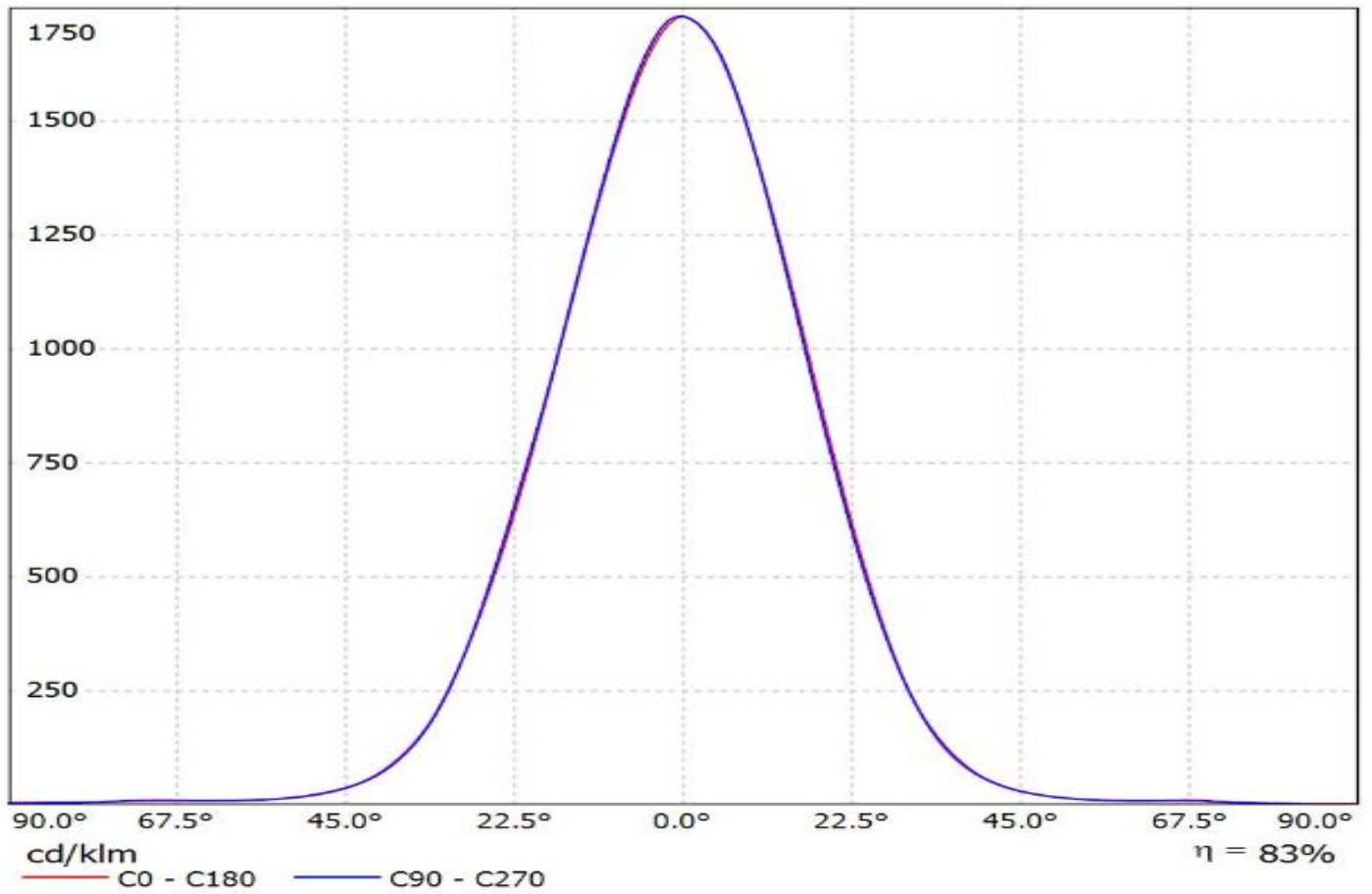

Luminaire: LEDiL Oy C10686_EVA-W (NS9x383) Eff.80.5%
Lamps: 1 x Nichia NS9x383 (107.656lm@250mA)

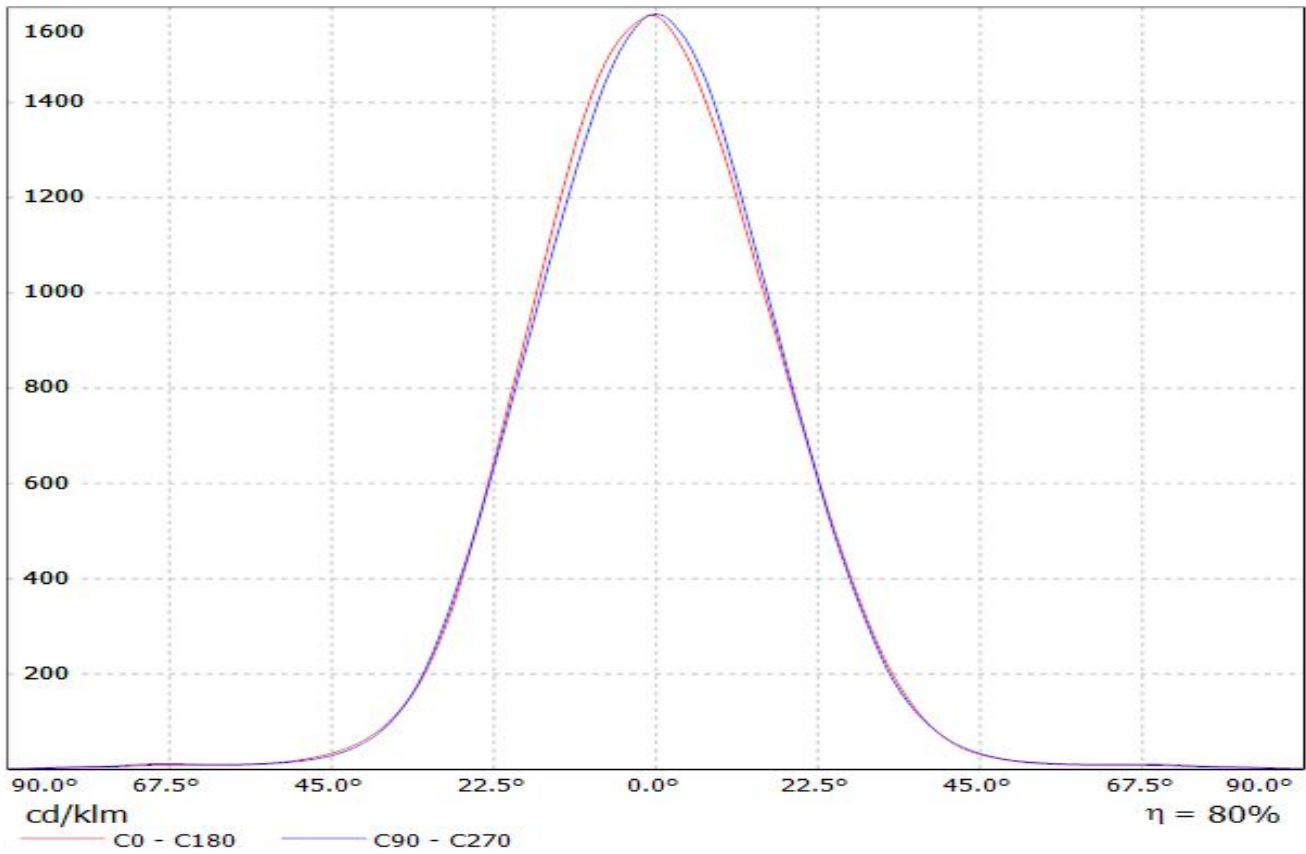

Luminaire: LEDiL Oy C10686_EVA-W_(NICHIA_286) Eff.80%
Lamps: 1 x NICHIA_286_(NSML286ME) 322.274lm@100mA CCT=3000K P=3.42532W I=100.1mA

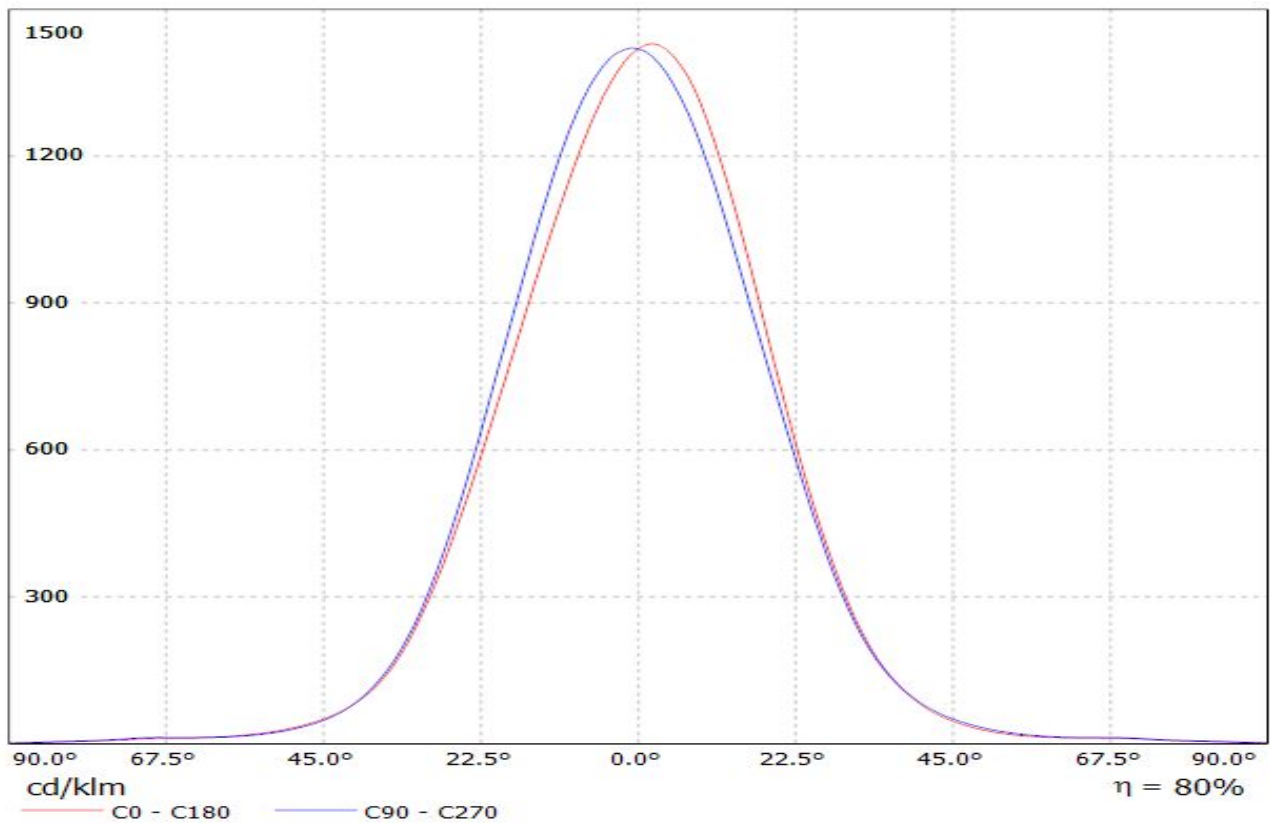

Luminaire: LEDil Oy C10686_EVA-W_(DURIS_S8) Efficiency=81%
Lamps: 1 x Osram DURIS S8 192lm @ 100mA CCT=2900K P=1.8W I=100mA

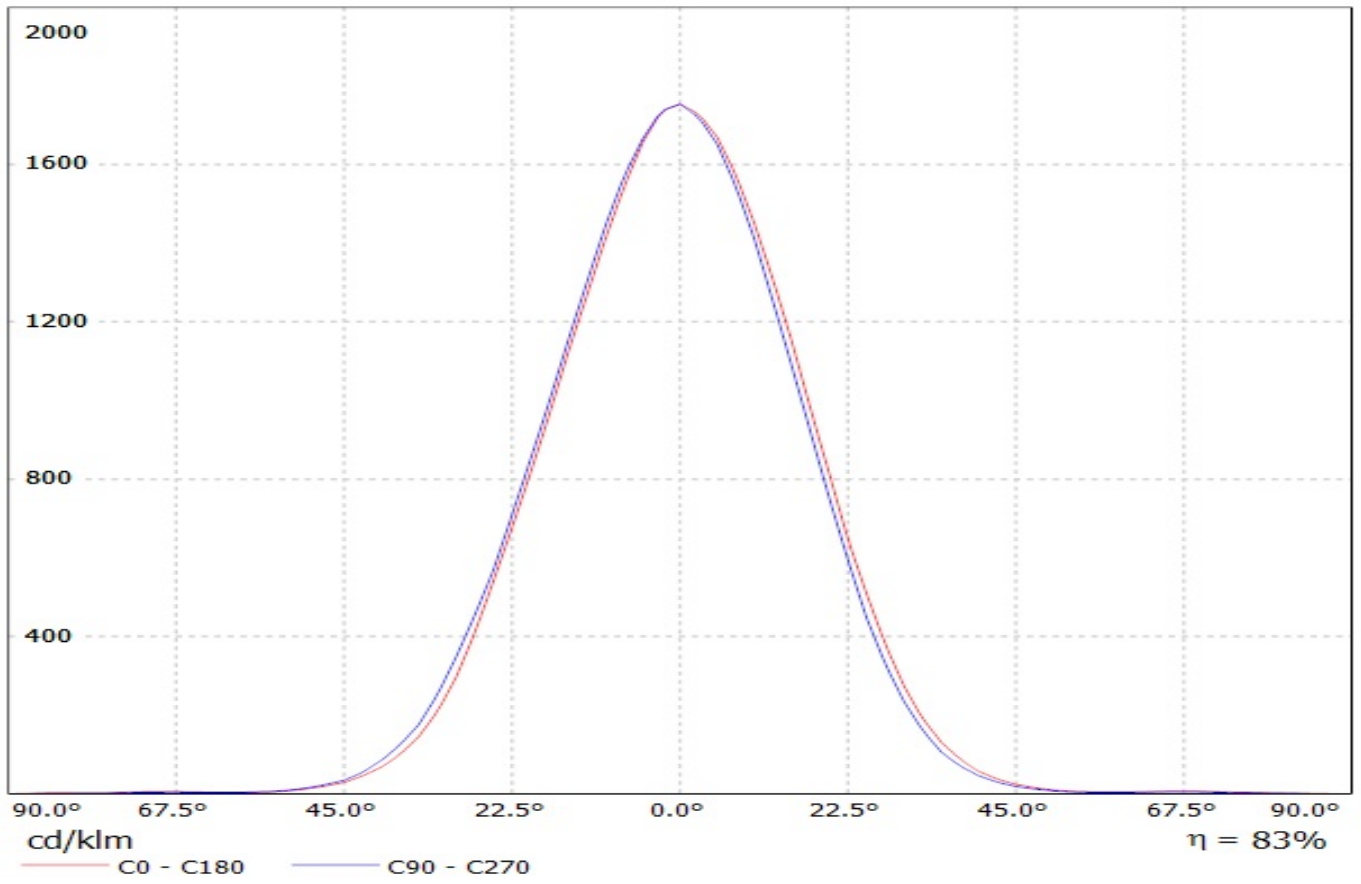

Ledil Oy C10686_Eva-MC-W C10686_Eva-MC-W / LDC (Polar)

Luminaire: Ledil Oy C10686_Eva-MC-W C10686_Eva-MC-W

Lamps: 1 x Cree MC-E (white)

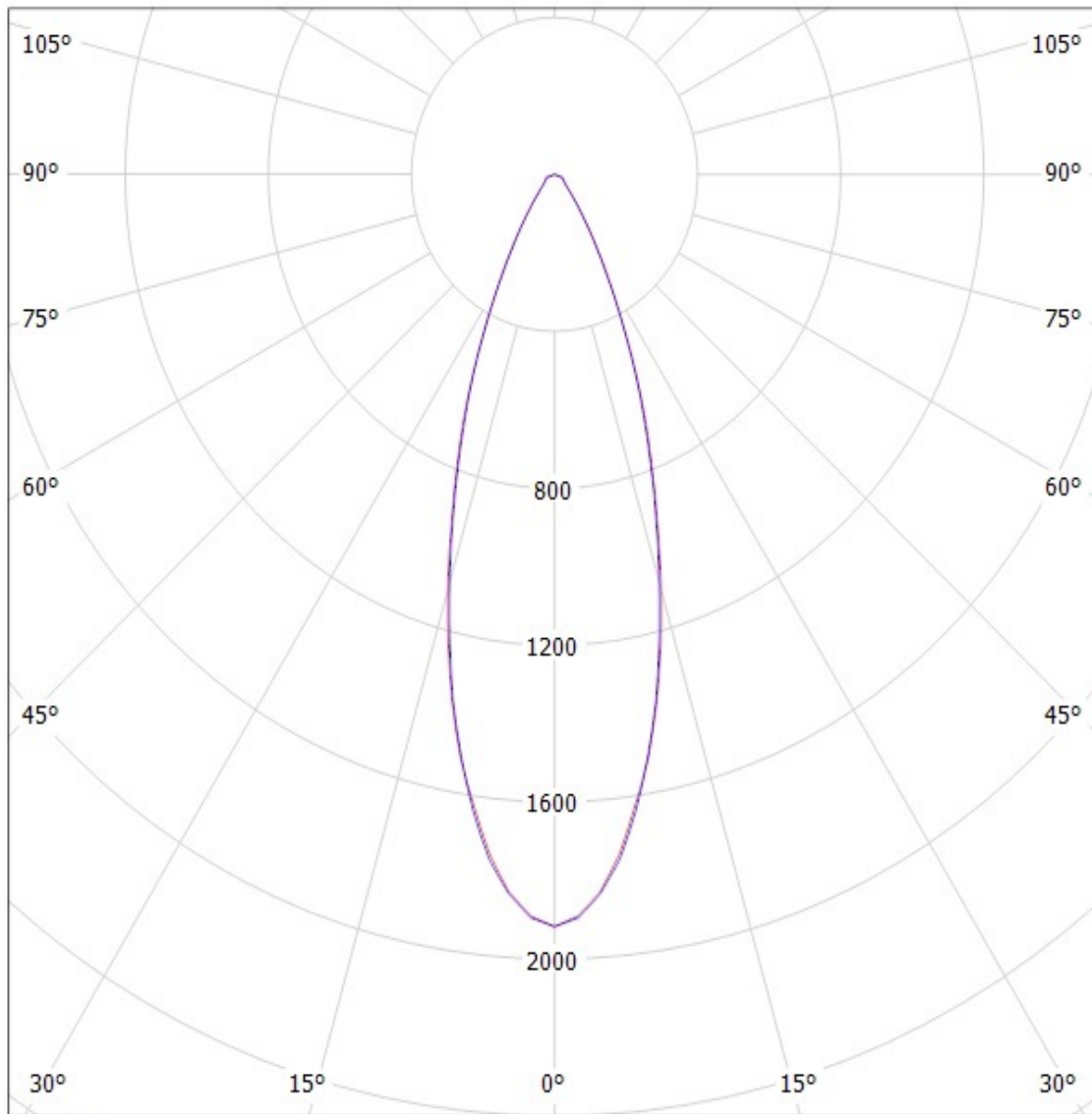

cd/klm

— C0 - C180

— C90 - C270

SIMULATED

Luminaire: LEDiL Oy C10686_EVA-W_(MK-R) Eff. 79,8%
Lamps: 1 x Cree MK-R (356lm@250mA)

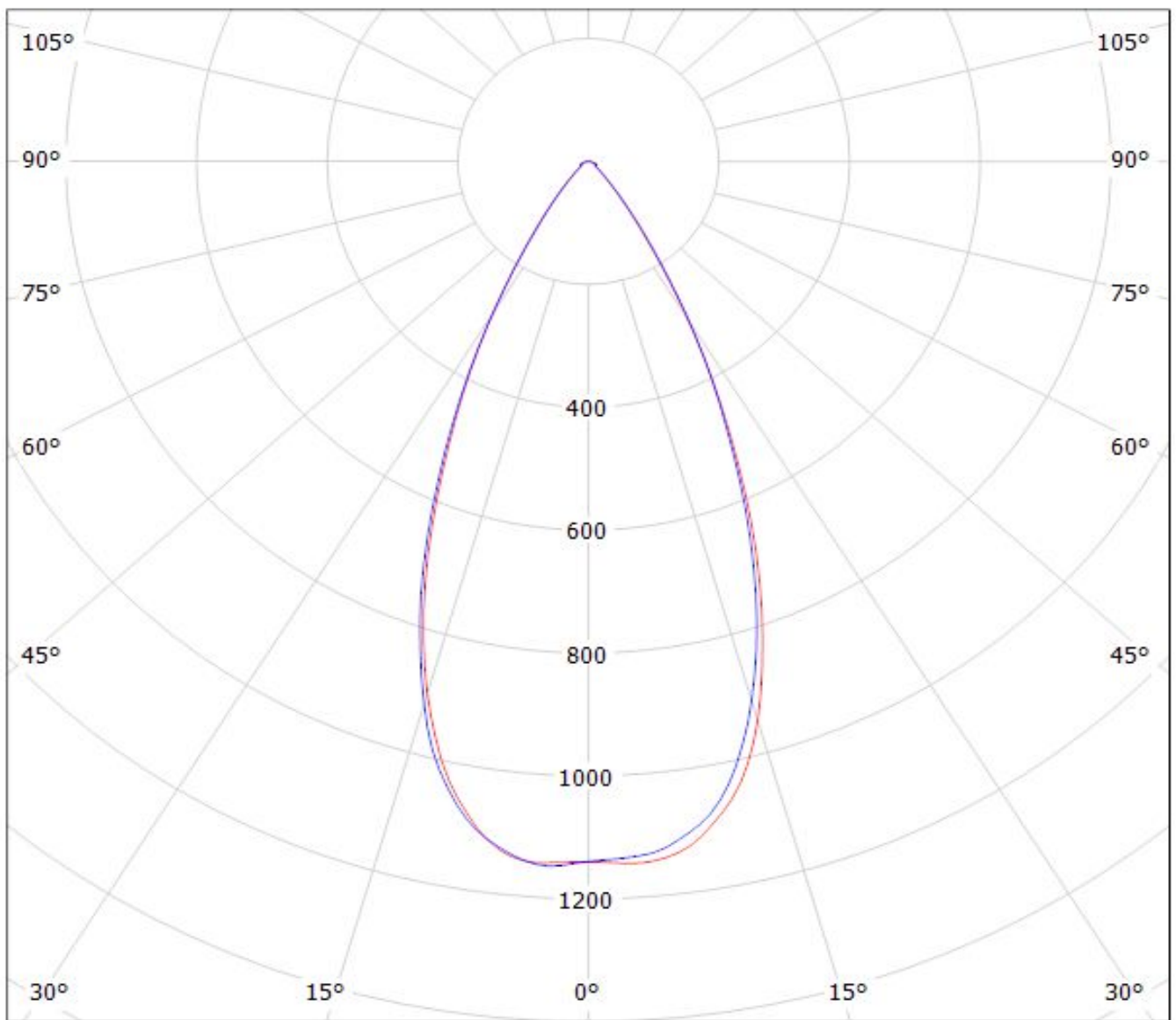

cd/klm

— C0 - C180 — C90 - C270

$\eta = 80\%$

Luminaire: Ledil C10686_EVA-W (Luxeon M) Efficiency=80%
Lamps: 1 x Luxeon M (362lm @ 250mA)

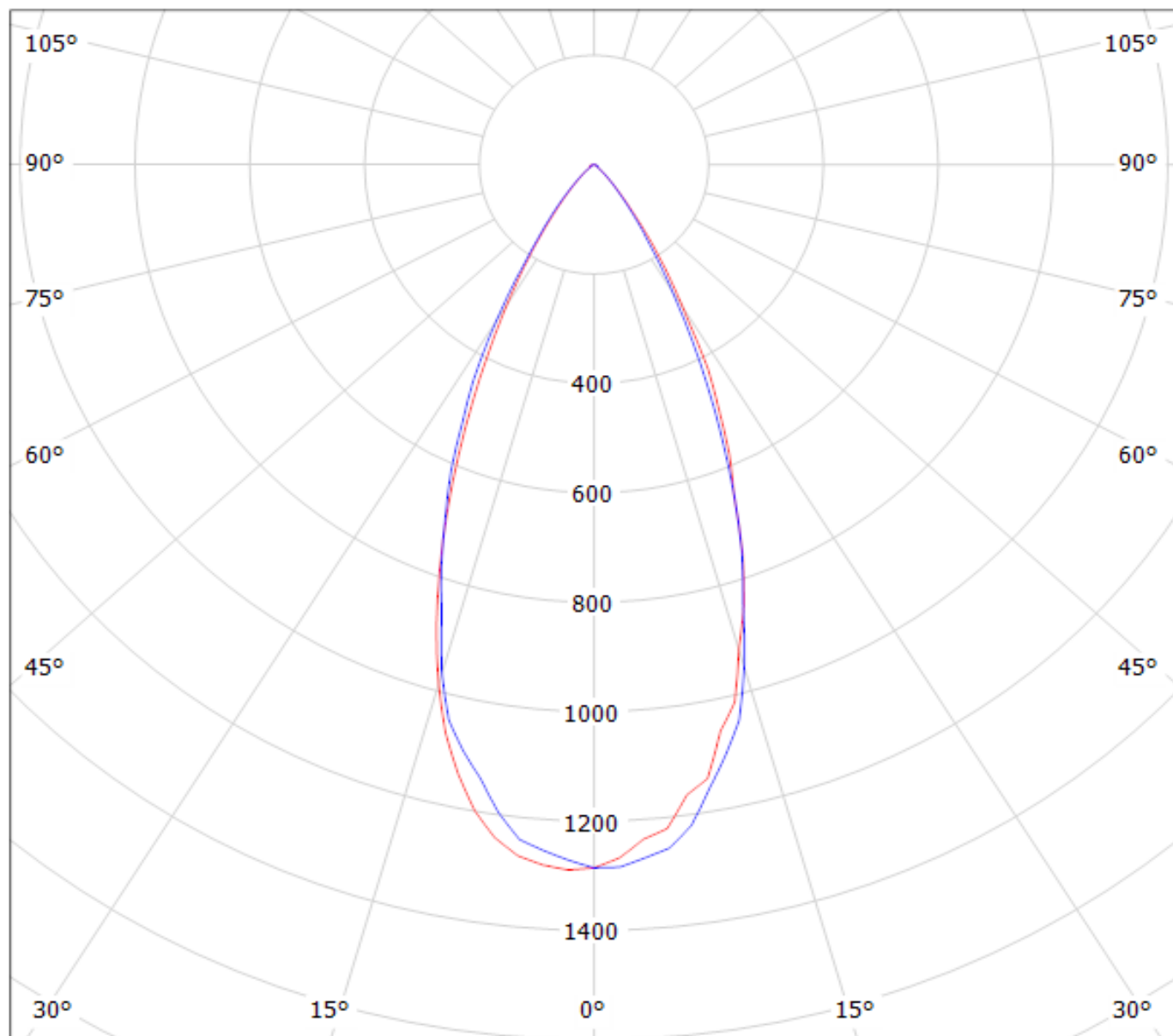

cd/klm

— C0 - C180

— C90 - C270

Luminaire: LEDil OY C10686_EVA-W_(Luxeon_MZ) Efficiency=81%
Lamps: 1 x Philips Lumileds Luxeon MZ (389lm @ 250mA) CCT=3800K P=2.8W I=250mA

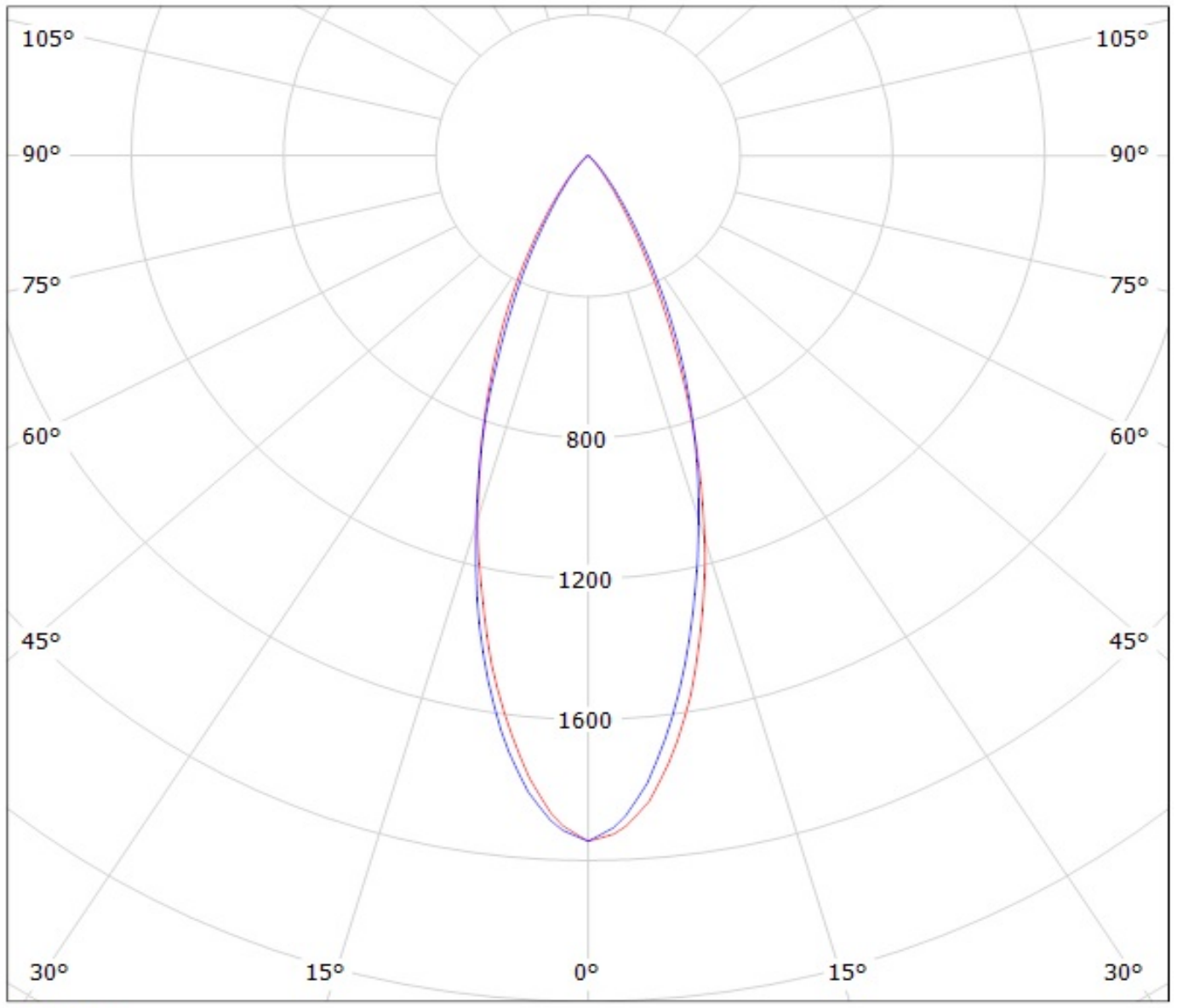

cd/klm
— C0 - C180 — C90 - C270

Luminaire: LEDiL Oy C10686_EVA-W_(Luxeon_5050)_(Luxeon_5050)

Lamps: 1 x Luxeon_5050_316.623lm@80mA_CCT=5700K_P=1.82294W_I=0.080A_70CRI

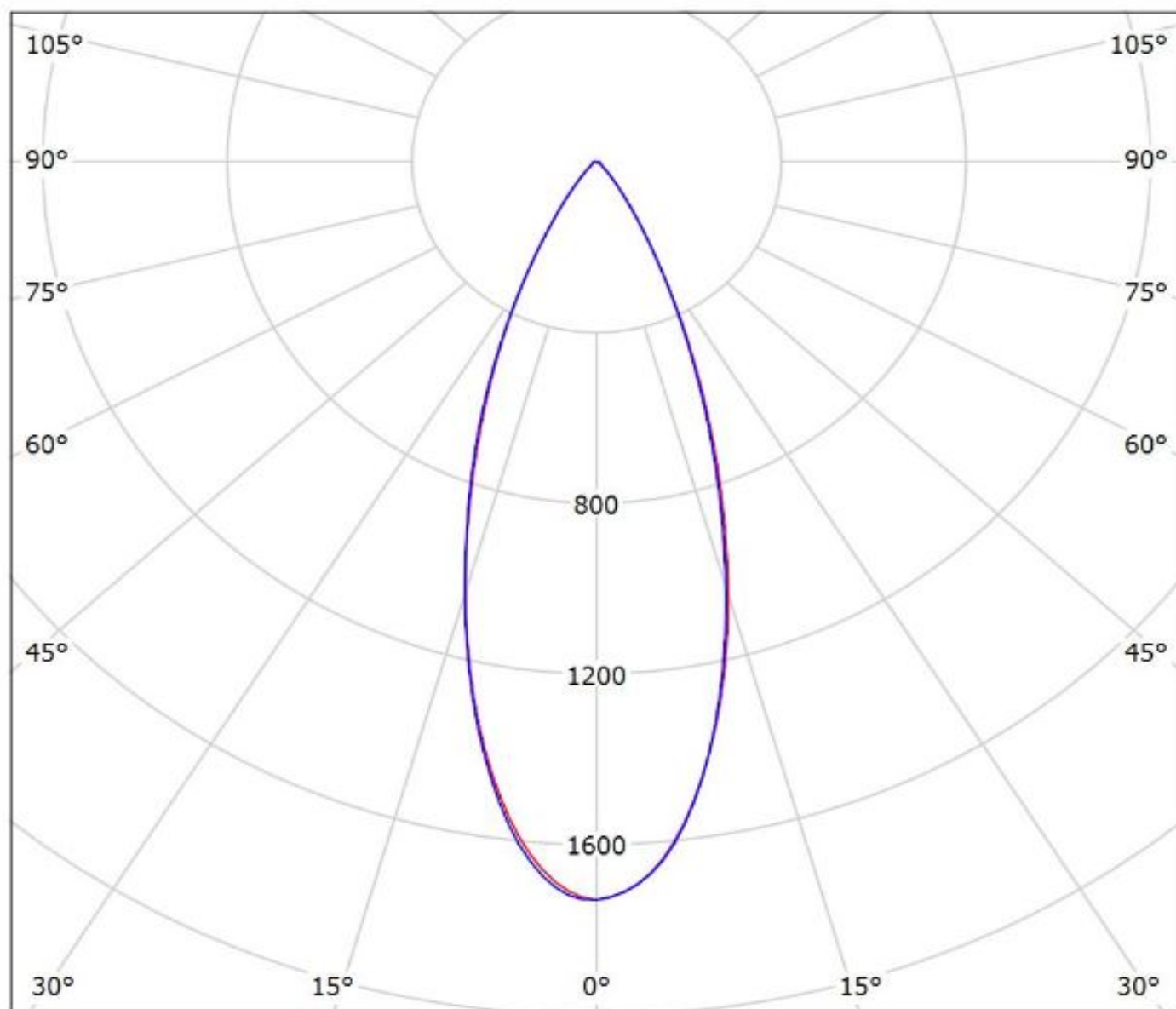

cd/klm

— C0 - C180 — C90 - C270

η = 83%

Luminaire: LEDiL Oy C10686_EVA-W (NS9x383) Eff.80.5%
Lamps: 1 x Nichia NS9x383 (107.656lm@250mA)

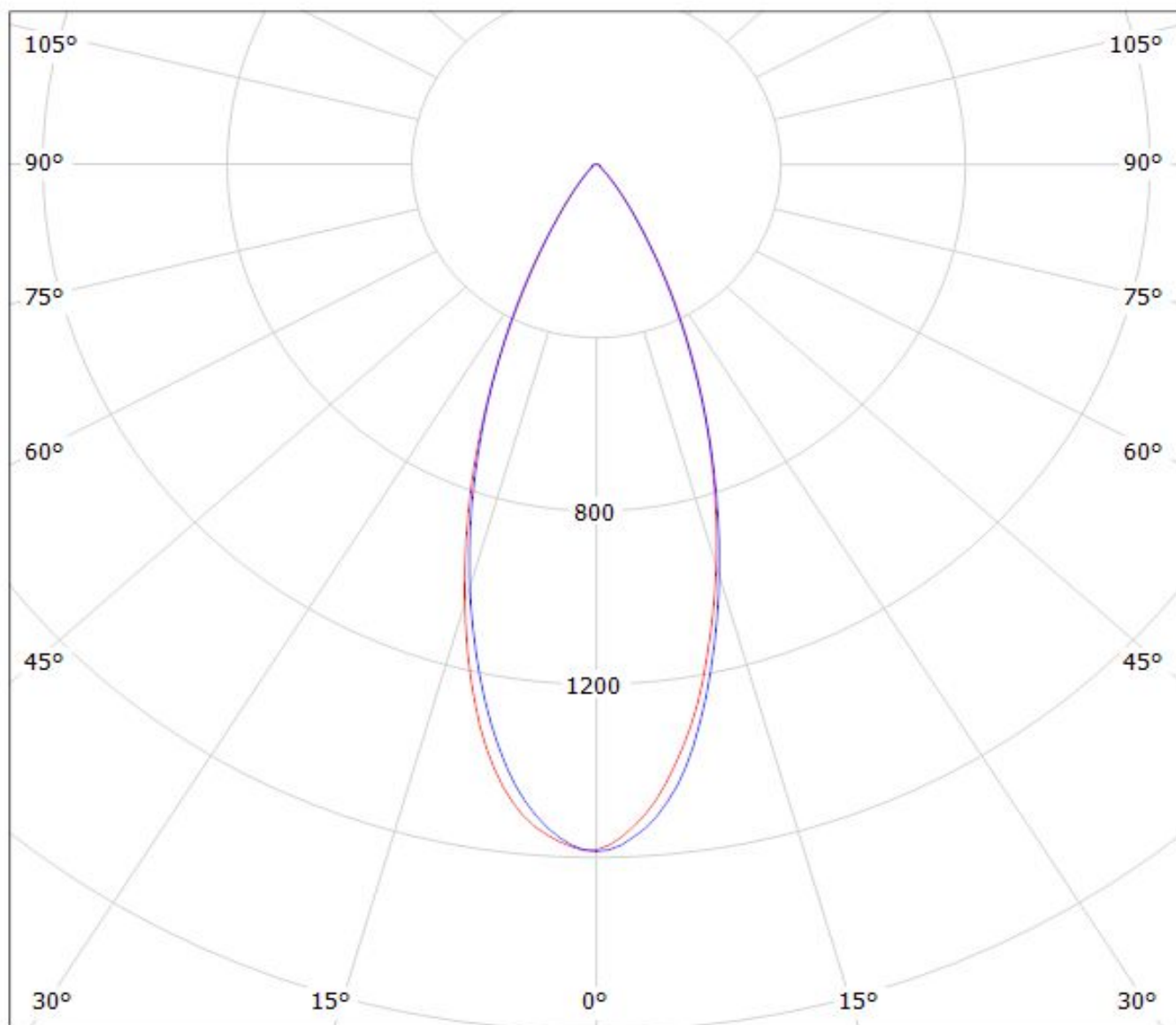

cd/klm

$\eta = 80\%$

— C0 - C180

— C90 - C270

Luminaire: LEDiL Oy C10686_EVA-W_(NICHIA_286) Eff.80%

Lamps: 1 x NICHIA_286_(NSML286ME) 322.274lm@100mA CCT=3000K P=3.42532W I=100.1mA

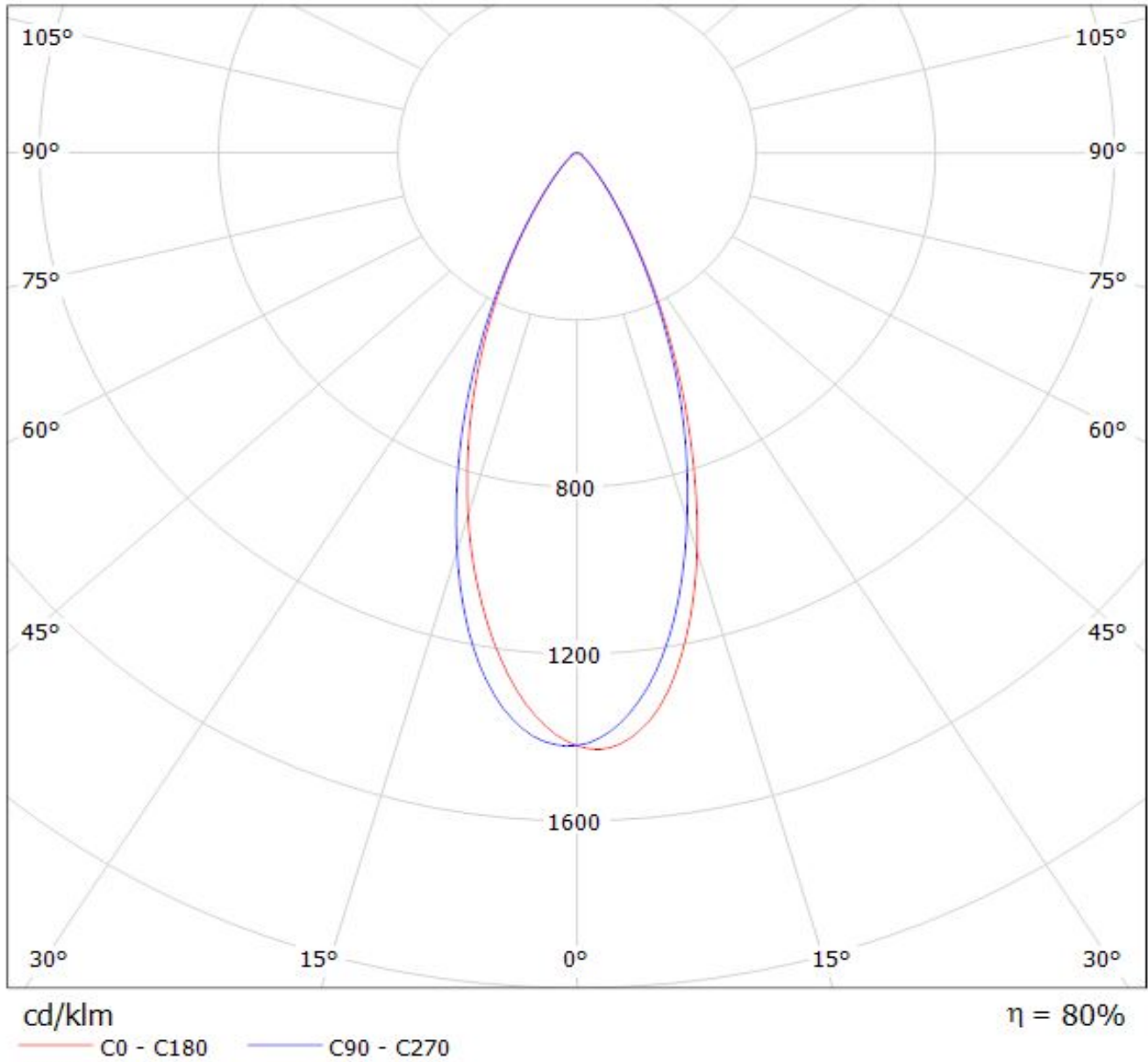

Luminaire: LEDil Oy C10686_EVA-W_(DURIS_S8) Efficiency=81%
Lamps: 1 x Osram DURIS S8 192lm @ 100mA CCT=2900K P=1.8W I=100mA

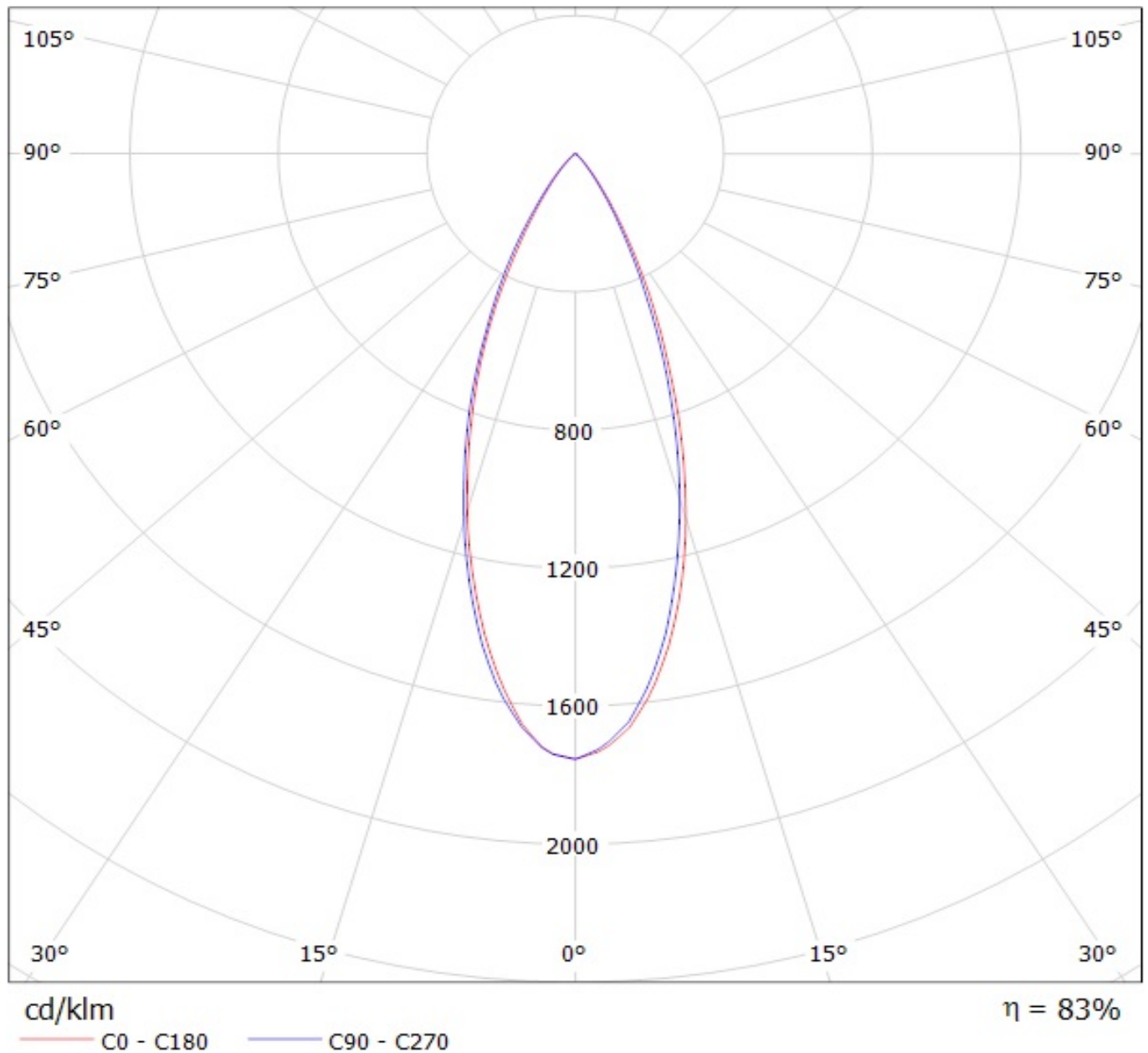

NOTE: The typical divergence will be changed by different color, chip size and chip position tolerance. The typical total divergence is the full angle measured where the luminous intensity is half of the peak value.