

# LM35

## Precision Centigrade Temperature Sensors

### General Description

The LM35 series are precision integrated-circuit temperature sensors, whose output voltage is linearly proportional to the Celsius (Centigrade) temperature. The LM35 thus has an advantage over linear temperature sensors calibrated in ° Kelvin, as the user is not required to subtract a large constant voltage from its output to obtain convenient Centigrade scaling. The LM35 does not require any external calibration or trimming to provide typical accuracies of  $\pm 1/4^\circ\text{C}$  at room temperature and  $\pm 3/4^\circ\text{C}$  over a full  $-55$  to  $+150^\circ\text{C}$  temperature range. Low cost is assured by trimming and calibration at the wafer level. The LM35's low output impedance, linear output, and precise inherent calibration make interfacing to readout or control circuitry especially easy. It can be used with single power supplies, or with plus and minus supplies. As it draws only  $60\ \mu\text{A}$  from its supply, it has very low self-heating, less than  $0.1^\circ\text{C}$  in still air. The LM35 is rated to operate over a  $-55^\circ$  to  $+150^\circ\text{C}$  temperature range, while the LM35C is rated for a  $-40^\circ$  to  $+110^\circ\text{C}$  range ( $-10^\circ$  with improved accuracy). The LM35 series is available pack-

aged in hermetic TO-46 transistor packages, while the LM35C, LM35CA, and LM35D are also available in the plastic TO-92 transistor package. The LM35D is also available in an 8-lead surface mount small outline package and a plastic TO-220 package.

### Features

- Calibrated directly in ° Celsius (Centigrade)
- Linear + 10.0 mV/°C scale factor
- 0.5°C accuracy guaranteeable (at +25°C)
- Rated for full  $-55^\circ$  to  $+150^\circ\text{C}$  range
- Suitable for remote applications
- Low cost due to wafer-level trimming
- Operates from 4 to 30 volts
- Less than  $60\ \mu\text{A}$  current drain
- Low self-heating,  $0.08^\circ\text{C}$  in still air
- Nonlinearity only  $\pm 1/4^\circ\text{C}$  typical
- Low impedance output,  $0.1\ \Omega$  for 1 mA load

### Typical Applications

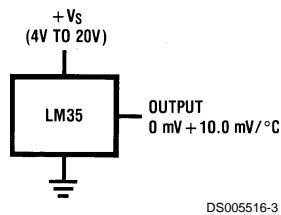

**FIGURE 1. Basic Centigrade Temperature Sensor (+2°C to +150°C)**

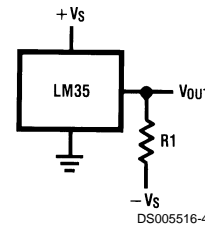

Choose  $R_1 = -V_S/50\ \mu\text{A}$   
 $V_{\text{OUT}} = +1,500\ \text{mV}$  at  $+150^\circ\text{C}$   
 $= +250\ \text{mV}$  at  $+25^\circ\text{C}$   
 $= -550\ \text{mV}$  at  $-55^\circ\text{C}$

**FIGURE 2. Full-Range Centigrade Temperature Sensor**

## Connection Diagrams

**TO-46**  
Metal Can Package\*

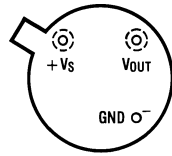

BOTTOM VIEW  
DS005516-1

\*Case is connected to negative pin (GND)

**Order Number LM35H, LM35AH, LM35CH, LM35CAH or LM35DH**

**See NS Package Number H03H**

**TO-92**  
Plastic Package

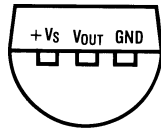

BOTTOM VIEW  
DS005516-2

**Order Number LM35CZ,  
LM35CAZ or LM35DZ**  
**See NS Package Number Z03A**

**SO-8**  
Small Outline Molded Package

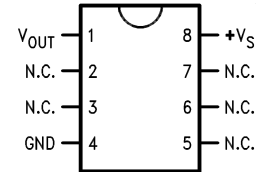

DS005516-21

N.C. = No Connection

**Top View**  
**Order Number LM35DM**  
**See NS Package Number M08A**

**TO-220**  
Plastic Package\*

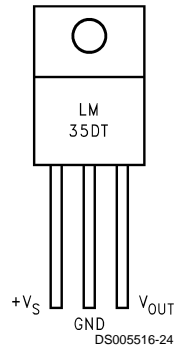

DS005516-24

\*Tab is connected to the negative pin (GND).

**Note:** The LM35DT pinout is different than the discontinued LM35DP.

**Order Number LM35DT**  
**See NS Package Number TA03F**

**Absolute Maximum Ratings** (Note 10)

If Military/Aerospace specified devices are required, please contact the National Semiconductor Sales Office/Distributors for availability and specifications.

Supply Voltage	+35V to -0.2V
Output Voltage	+6V to -1.0V
Output Current	10 mA
Storage Temp.;	
TO-46 Package,	-60°C to +180°C
TO-92 Package,	-60°C to +150°C
SO-8 Package,	-65°C to +150°C
TO-220 Package,	-65°C to +150°C
Lead Temp.:	
TO-46 Package,	
(Soldering, 10 seconds)	300°C

TO-92 and TO-220 Package, (Soldering, 10 seconds)	260°C
SO Package (Note 12)	
Vapor Phase (60 seconds)	215°C
Infrared (15 seconds)	220°C
ESD Susceptibility (Note 11)	2500V
Specified Operating Temperature Range: $T_{MIN}$ to $T_{MAX}$ (Note 2)	
LM35, LM35A	-55°C to +150°C
LM35C, LM35CA	-40°C to +110°C
LM35D	0°C to +100°C

**Electrical Characteristics**

(Notes 1, 6)

Parameter	Conditions	LM35A			LM35CA			Units (Max.)
		Typical	Tested Limit (Note 4)	Design Limit (Note 5)	Typical	Tested Limit (Note 4)	Design Limit (Note 5)	
Accuracy (Note 7)	$T_A = +25^\circ\text{C}$	$\pm 0.2$	$\pm 0.5$		$\pm 0.2$	$\pm 0.5$		°C
	$T_A = -10^\circ\text{C}$	$\pm 0.3$			$\pm 0.3$		$\pm 1.0$	°C
	$T_A = T_{MAX}$	$\pm 0.4$	$\pm 1.0$		$\pm 0.4$	$\pm 1.0$		°C
	$T_A = T_{MIN}$	$\pm 0.4$	$\pm 1.0$		$\pm 0.4$		$\pm 1.5$	°C
Nonlinearity (Note 8)	$T_{MIN} \leq T_A \leq T_{MAX}$	<b><math>\pm 0.18</math></b>		<b><math>\pm 0.35</math></b>	<b><math>\pm 0.15</math></b>		<b><math>\pm 0.3</math></b>	°C
Sensor Gain (Average Slope)	$T_{MIN} \leq T_A \leq T_{MAX}$	<b>+10.0</b>	<b>+9.9,</b> <b>+10.1</b>		<b>+10.0</b>		<b>+9.9,</b> <b>+10.1</b>	mV/°C
Load Regulation (Note 3) $0 \leq I_L \leq 1$ mA	$T_A = +25^\circ\text{C}$	$\pm 0.4$	$\pm 1.0$		$\pm 0.4$	$\pm 1.0$		mV/mA
	$T_{MIN} \leq T_A \leq T_{MAX}$	<b><math>\pm 0.5</math></b>		<b><math>\pm 3.0</math></b>	<b><math>\pm 0.5</math></b>		<b><math>\pm 3.0</math></b>	mV/mA
Line Regulation (Note 3)	$T_A = +25^\circ\text{C}$	$\pm 0.01$	$\pm 0.05$		$\pm 0.01$	$\pm 0.05$		mV/V
	$4V \leq V_S \leq 30V$	<b><math>\pm 0.02</math></b>		<b><math>\pm 0.1</math></b>	<b><math>\pm 0.02</math></b>		<b><math>\pm 0.1</math></b>	mV/V
Quiescent Current (Note 9)	$V_S = +5V, +25^\circ\text{C}$	56	67		56	67		μA
	$V_S = +5V$	<b>105</b>		<b>131</b>	<b>91</b>		<b>114</b>	μA
	$V_S = +30V, +25^\circ\text{C}$	56.2	68		56.2	68		μA
	$V_S = +30V$	<b>105.5</b>		<b>133</b>	<b>91.5</b>		<b>116</b>	μA
Change of Quiescent Current (Note 3)	$4V \leq V_S \leq 30V, +25^\circ\text{C}$	0.2	1.0		0.2	1.0		μA
	$4V \leq V_S \leq 30V$	<b>0.5</b>		<b>2.0</b>	<b>0.5</b>		<b>2.0</b>	μA
Temperature Coefficient of Quiescent Current		<b>+0.39</b>		<b>+0.5</b>	<b>+0.39</b>		<b>+0.5</b>	μA/°C
Minimum Temperature for Rated Accuracy	In circuit of <i>Figure 1</i> , $I_L = 0$	+1.5		+2.0	+1.5		+2.0	°C
Long Term Stability	$T_J = T_{MAX}$ , for 1000 hours	$\pm 0.08$			$\pm 0.08$			°C

## Electrical Characteristics

(Notes 1, 6)

Parameter	Conditions	LM35			LM35C, LM35D			Units (Max.)
		Typical	Tested Limit (Note 4)	Design Limit (Note 5)	Typical	Tested Limit (Note 4)	Design Limit (Note 5)	
Accuracy, LM35, LM35C (Note 7)	$T_A = +25^\circ\text{C}$	$\pm 0.4$	$\pm 1.0$		$\pm 0.4$	$\pm 1.0$		$^\circ\text{C}$
	$T_A = -10^\circ\text{C}$	$\pm 0.5$			$\pm 0.5$		$\pm 1.5$	$^\circ\text{C}$
	$T_A = T_{\text{MAX}}$	$\pm 0.8$	$\pm 1.5$		$\pm 0.8$		$\pm 1.5$	$^\circ\text{C}$
	$T_A = T_{\text{MIN}}$	$\pm 0.8$		$\pm 1.5$	$\pm 0.8$		$\pm 2.0$	$^\circ\text{C}$
Accuracy, LM35D (Note 7)	$T_A = +25^\circ\text{C}$				$\pm 0.6$	$\pm 1.5$		$^\circ\text{C}$
	$T_A = T_{\text{MAX}}$				$\pm 0.9$		$\pm 2.0$	$^\circ\text{C}$
	$T_A = T_{\text{MIN}}$				$\pm 0.9$		$\pm 2.0$	$^\circ\text{C}$
Nonlinearity (Note 8)	$T_{\text{MIN}} \leq T_A \leq T_{\text{MAX}}$	<b><math>\pm 0.3</math></b>		<b><math>\pm 0.5</math></b>	<b><math>\pm 0.2</math></b>		<b><math>\pm 0.5</math></b>	$^\circ\text{C}$
Sensor Gain (Average Slope)	$T_{\text{MIN}} \leq T_A \leq T_{\text{MAX}}$	<b>+10.0</b>	<b>+9.8,</b> <b>+10.2</b>		<b>+10.0</b>		<b>+9.8,</b> <b>+10.2</b>	mV/ $^\circ\text{C}$
Load Regulation (Note 3) $0 \leq I_L \leq 1 \text{ mA}$	$T_A = +25^\circ\text{C}$	$\pm 0.4$	$\pm 2.0$		$\pm 0.4$	$\pm 2.0$		mV/mA
	$T_{\text{MIN}} \leq T_A \leq T_{\text{MAX}}$	<b><math>\pm 0.5</math></b>		<b><math>\pm 5.0</math></b>	<b><math>\pm 0.5</math></b>		<b><math>\pm 5.0</math></b>	mV/mA
Line Regulation (Note 3)	$T_A = +25^\circ\text{C}$	$\pm 0.01$	$\pm 0.1$		$\pm 0.01$	$\pm 0.1$		mV/V
	$4\text{V} \leq V_S \leq 30\text{V}$	<b><math>\pm 0.02</math></b>		<b><math>\pm 0.2</math></b>	<b><math>\pm 0.02</math></b>		<b><math>\pm 0.2</math></b>	mV/V
Quiescent Current (Note 9)	$V_S = +5\text{V}, +25^\circ\text{C}$	56	80		56	80		$\mu\text{A}$
	$V_S = +5\text{V}$	<b>105</b>		<b>158</b>	<b>91</b>		<b>138</b>	$\mu\text{A}$
	$V_S = +30\text{V}, +25^\circ\text{C}$	56.2	82		56.2	82		$\mu\text{A}$
	$V_S = +30\text{V}$	<b>105.5</b>		<b>161</b>	<b>91.5</b>		<b>141</b>	$\mu\text{A}$
Change of Quiescent Current (Note 3)	$4\text{V} \leq V_S \leq 30\text{V}, +25^\circ\text{C}$	0.2	2.0		0.2	2.0		$\mu\text{A}$
	$4\text{V} \leq V_S \leq 30\text{V}$	<b>0.5</b>		<b>3.0</b>	<b>0.5</b>		<b>3.0</b>	$\mu\text{A}$
Temperature Coefficient of Quiescent Current		<b>+0.39</b>		<b>+0.7</b>	<b>+0.39</b>		<b>+0.7</b>	$\mu\text{A}/^\circ\text{C}$
Minimum Temperature for Rated Accuracy	In circuit of <i>Figure 1</i> , $I_L = 0$	+1.5		+2.0	+1.5		+2.0	$^\circ\text{C}$
Long Term Stability	$T_J = T_{\text{MAX}}$ , for 1000 hours	$\pm 0.08$			$\pm 0.08$			$^\circ\text{C}$

**Note 1:** Unless otherwise noted, these specifications apply:  $-55^\circ\text{C} \leq T_J \leq +150^\circ\text{C}$  for the LM35 and LM35A;  $-40^\circ\text{C} \leq T_J \leq +110^\circ\text{C}$  for the LM35C and LM35CA; and  $0^\circ\text{C} \leq T_J \leq +100^\circ\text{C}$  for the LM35D.  $V_S = +5\text{Vdc}$  and  $I_{\text{LOAD}} = 50 \mu\text{A}$ , in the circuit of *Figure 2*. These specifications also apply from  $+2^\circ\text{C}$  to  $T_{\text{MAX}}$  in the circuit of *Figure 1*. Specifications in **boldface** apply over the full rated temperature range.

**Note 2:** Thermal resistance of the TO-46 package is  $400^\circ\text{C}/\text{W}$ , junction to ambient, and  $24^\circ\text{C}/\text{W}$  junction to case. Thermal resistance of the TO-92 package is  $180^\circ\text{C}/\text{W}$  junction to ambient. Thermal resistance of the small outline molded package is  $220^\circ\text{C}/\text{W}$  junction to ambient. Thermal resistance of the TO-220 package is  $90^\circ\text{C}/\text{W}$  junction to ambient. For additional thermal resistance information see table in the Applications section.

**Note 3:** Regulation is measured at constant junction temperature, using pulse testing with a low duty cycle. Changes in output due to heating effects can be computed by multiplying the internal dissipation by the thermal resistance.

**Note 4:** Tested Limits are guaranteed and 100% tested in production.

**Note 5:** Design Limits are guaranteed (but not 100% production tested) over the indicated temperature and supply voltage ranges. These limits are not used to calculate outgoing quality levels.

**Note 6:** Specifications in **boldface** apply over the full rated temperature range.

**Note 7:** Accuracy is defined as the error between the output voltage and  $10\text{mv}/^\circ\text{C}$  times the device's case temperature, at specified conditions of voltage, current, and temperature (expressed in  $^\circ\text{C}$ ).

**Note 8:** Nonlinearity is defined as the deviation of the output-voltage-versus-temperature curve from the best-fit straight line, over the device's rated temperature range.

**Note 9:** Quiescent current is defined in the circuit of *Figure 1*.

**Note 10:** Absolute Maximum Ratings indicate limits beyond which damage to the device may occur. DC and AC electrical specifications do not apply when operating the device beyond its rated operating conditions. See Note 1.

**Note 11:** Human body model,  $100 \text{ pF}$  discharged through a  $1.5 \text{ k}\Omega$  resistor.

**Note 12:** See AN-450 "Surface Mounting Methods and Their Effect on Product Reliability" or the section titled "Surface Mount" found in a current National Semiconductor Linear Data Book for other methods of soldering surface mount devices.

# Typical Performance Characteristics

**Thermal Resistance Junction to Air**

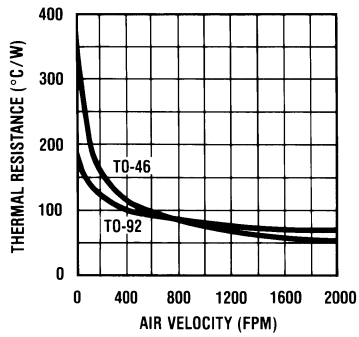

DS005516-25

**Thermal Time Constant**

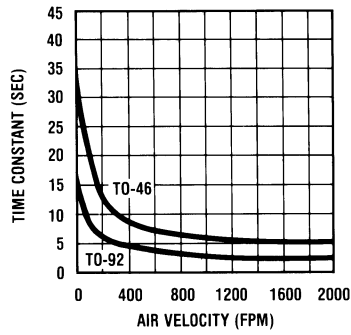

DS005516-26

**Thermal Response in Still Air**

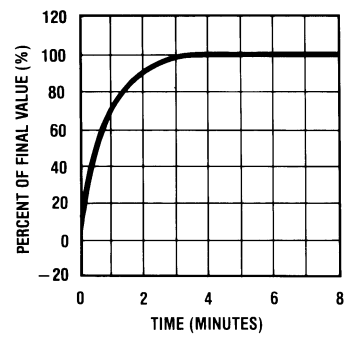

DS005516-27

**Thermal Response in Stirred Oil Bath**

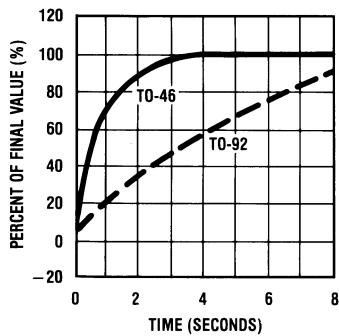

DS005516-28

**Minimum Supply Voltage vs. Temperature**

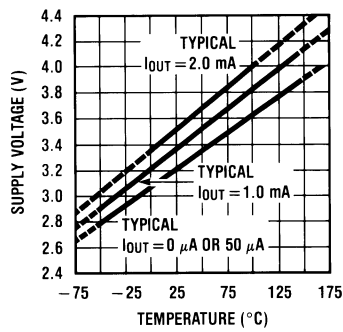

DS005516-29

**Quiescent Current vs. Temperature (In Circuit of Figure 1.)**

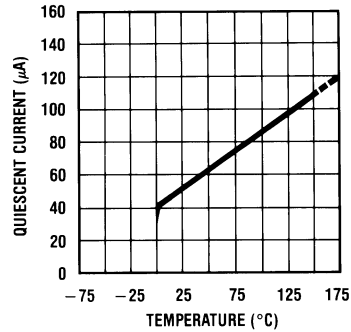

DS005516-30

**Quiescent Current vs. Temperature (In Circuit of Figure 2.)**

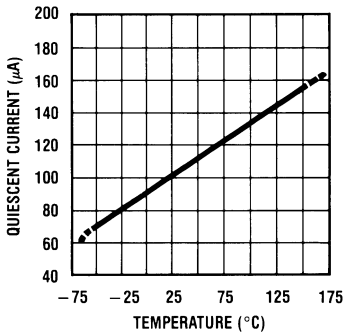

DS005516-31

**Accuracy vs. Temperature (Guaranteed)**

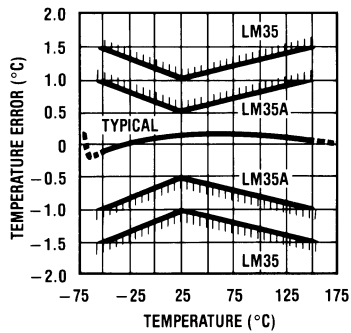

DS005516-32

**Accuracy vs. Temperature (Guaranteed)**

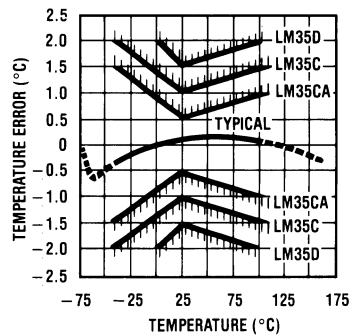

DS005516-33

## Typical Performance Characteristics (Continued)

**Noise Voltage**

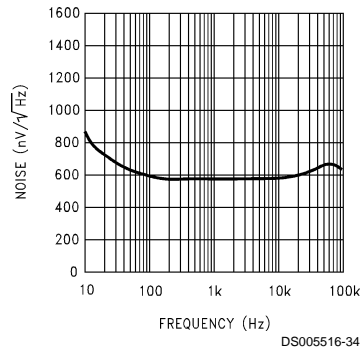

**Start-Up Response**

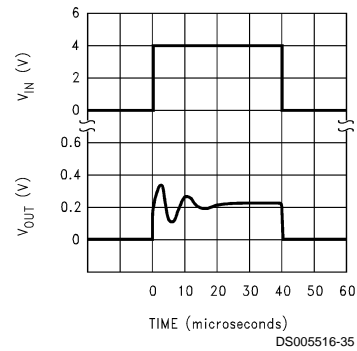

### Applications

The LM35 can be applied easily in the same way as other integrated-circuit temperature sensors. It can be glued or cemented to a surface and its temperature will be within about 0.01°C of the surface temperature.

This presumes that the ambient air temperature is almost the same as the surface temperature; if the air temperature were much higher or lower than the surface temperature, the actual temperature of the LM35 die would be at an intermediate temperature between the surface temperature and the air temperature. This is especially true for the TO-92 plastic package, where the copper leads are the principal thermal path to carry heat into the device, so its temperature might be closer to the air temperature than to the surface temperature.

To minimize this problem, be sure that the wiring to the LM35, as it leaves the device, is held at the same temperature as the surface of interest. The easiest way to do this is to cover up these wires with a bead of epoxy which will insure that the leads and wires are all at the same temperature as the surface, and that the LM35 die's temperature will not be affected by the air temperature.

The TO-46 metal package can also be soldered to a metal surface or pipe without damage. Of course, in that case the V- terminal of the circuit will be grounded to that metal. Alternatively, the LM35 can be mounted inside a sealed-end metal tube, and can then be dipped into a bath or screwed into a threaded hole in a tank. As with any IC, the LM35 and accompanying wiring and circuits must be kept insulated and dry, to avoid leakage and corrosion. This is especially true if the circuit may operate at cold temperatures where condensation can occur. Printed-circuit coatings and varnishes such as Humiseal and epoxy paints or dips are often used to insure that moisture cannot corrode the LM35 or its connections.

These devices are sometimes soldered to a small light-weight heat fin, to decrease the thermal time constant and speed up the response in slowly-moving air. On the other hand, a small thermal mass may be added to the sensor, to give the steadiest reading despite small deviations in the air temperature.

### Temperature Rise of LM35 Due To Self-heating (Thermal Resistance, $\theta_{JA}$ )

	TO-46, no heat sink	TO-46*, small heat fin	TO-92, no heat sink	TO-92**, small heat fin	SO-8 no heat sink	SO-8** small heat fin	TO-220 no heat sink
Still air	400°C/W	100°C/W	180°C/W	140°C/W	220°C/W	110°C/W	90°C/W
Moving air	100°C/W	40°C/W	90°C/W	70°C/W	105°C/W	90°C/W	26°C/W
Still oil	100°C/W	40°C/W	90°C/W	70°C/W			
Stirred oil	50°C/W	30°C/W	45°C/W	40°C/W			
(Clamped to metal, Infinite heat sink)		(24°C/W)				(55°C/W)	

\*Wakefield type 201, or 1" disc of 0.020" sheet brass, soldered to case, or similar.

\*\*TO-92 and SO-8 packages glued and leads soldered to 1" square of 1/16" printed circuit board with 2 oz. foil or similar.











**Physical Dimensions** inches (millimeters) unless otherwise noted

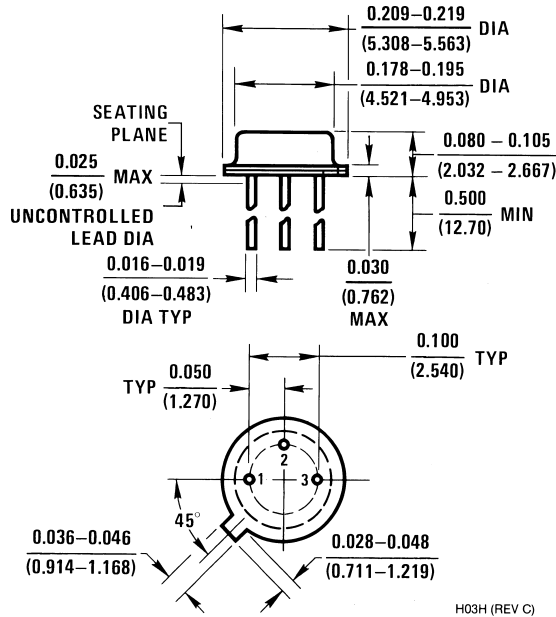

**TO-46 Metal Can Package (H)**  
 Order Number LM35H, LM35AH, LM35CH,  
 LM35CAH, or LM35DH  
 NS Package Number H03H

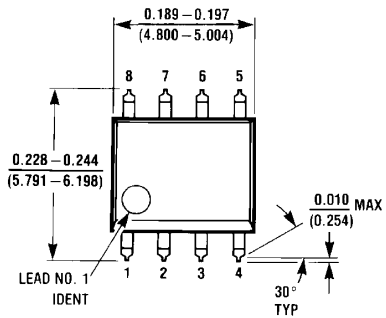

**SO-8 Molded Small Outline Package (M)**  
 Order Number LM35DM  
 NS Package Number M08A

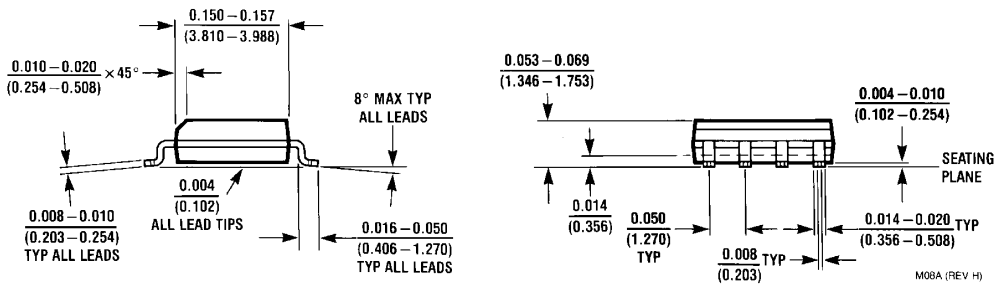

**Physical Dimensions** inches (millimeters) unless otherwise noted (Continued)

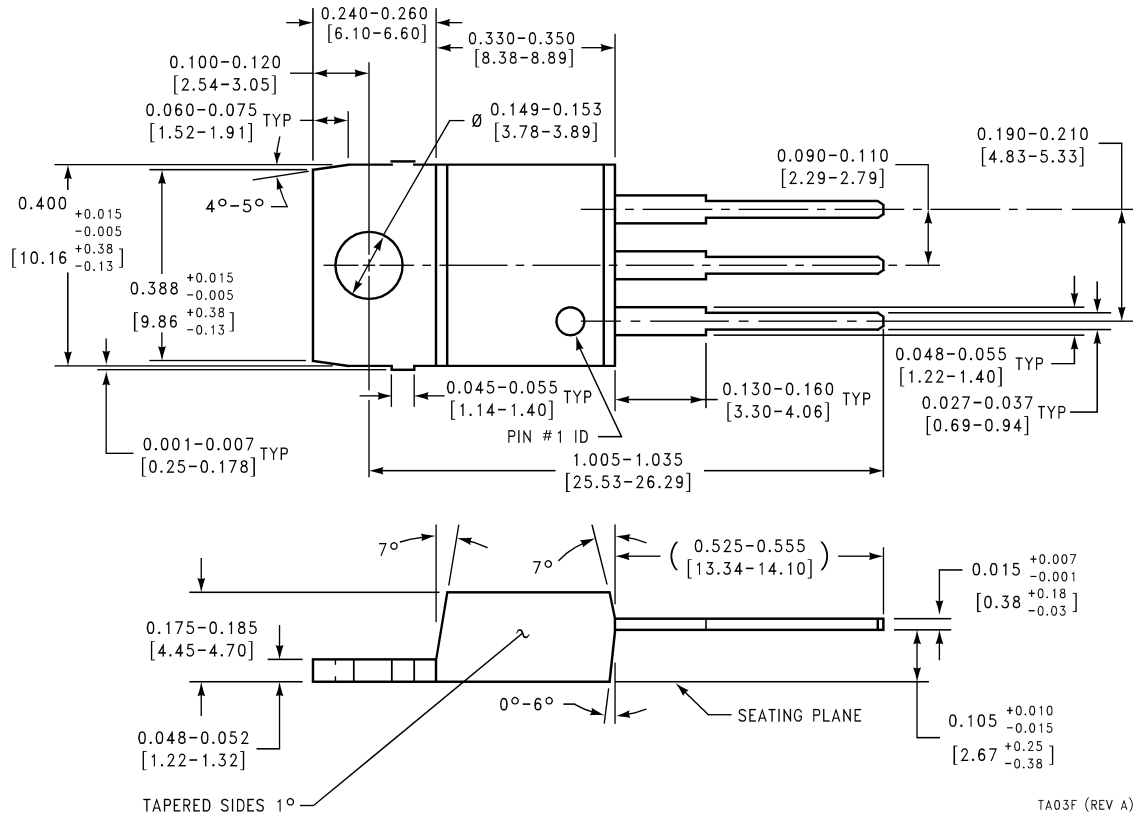

**Power Package TO-220 (T)**  
**Order Number LM35DT**  
**NS Package Number TA03F**

**Physical Dimensions** inches (millimeters) unless otherwise noted (Continued)

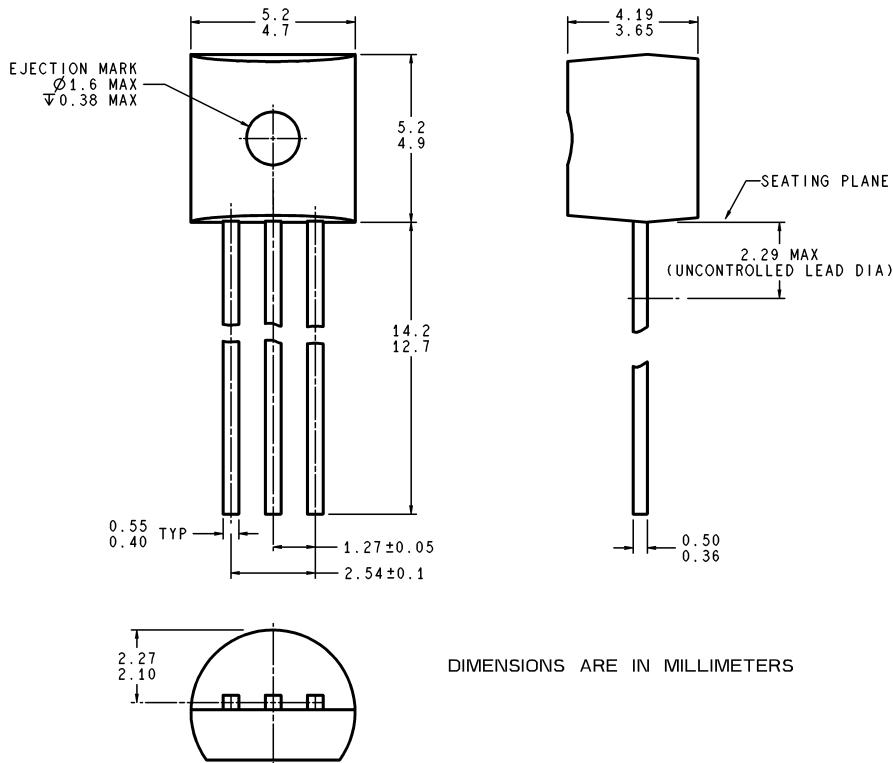

Z03A (Rev G)

**TO-92 Plastic Package (Z)**  
**Order Number LM35CZ, LM35CAZ or LM35DZ**  
**NS Package Number Z03A**

**LIFE SUPPORT POLICY**

NATIONAL'S PRODUCTS ARE NOT AUTHORIZED FOR USE AS CRITICAL COMPONENTS IN LIFE SUPPORT DEVICES OR SYSTEMS WITHOUT THE EXPRESS WRITTEN APPROVAL OF THE PRESIDENT AND GENERAL COUNSEL OF NATIONAL SEMICONDUCTOR CORPORATION. As used herein:

1. Life support devices or systems are devices or systems which, (a) are intended for surgical implant into the body, or (b) support or sustain life, and whose failure to perform when properly used in accordance with instructions for use provided in the labeling, can be reasonably expected to result in a significant injury to the user.
2. A critical component is any component of a life support device or system whose failure to perform can be reasonably expected to cause the failure of the life support device or system, or to affect its safety or effectiveness.

**National Semiconductor Corporation**  
Americas  
Tel: 1-800-272-9959  
Fax: 1-800-737-7018  
Email: support@nsc.com  
www.national.com

**National Semiconductor Europe**  
Fax: +49 (0) 180-530 85 86  
Email: europe.support@nsc.com  
Deutsch Tel: +49 (0) 69 9508 6208  
English Tel: +44 (0) 870 24 0 2171  
Français Tel: +33 (0) 1 41 91 8790

**National Semiconductor Asia Pacific Customer Response Group**  
Tel: 65-2544466  
Fax: 65-2504466  
Email: ap.support@nsc.com

**National Semiconductor Japan Ltd.**  
Tel: 81-3-5639-7560  
Fax: 81-3-5639-7507