

# **VECO** Foshan Vanson Electronics Co., Ltd.

168, Industrial Development Zone, Shitou Chun, Lanshi Zhen, Foshan, Guangdong, CHINA

TEL: +86-757- 8381 5788 FAX: +86-757- 8381 8577 E-mail: vecof@fs165.com

1.	<b>MODEL:</b>	<b>20CS08F-1-E50ND</b>	
2	Dimension & Weight	Outer Diameter <b>20<math>\phi</math></b> mm	Face side Dimension <b>19<math>\phi</math></b> mm
		Baffle Opening <b>19<math>\phi</math></b> mm	
		Height <b>Refer to drawing</b>	Weight <b>2.8</b> Grams
3	Magnet	Materials <b>Rare Earth</b>	Size <b><math>\phi</math>8.0 x1.0</b> mm
4.	Nominal Impedance	<b>8</b> $\Omega \pm 15 \%$ , At <b>1500</b> Hz.	
5.	Power Rating	Normal <b>0.5</b> Watts	Maximum <b>1.0</b> Watts Sine Wave.
		Normal Watts	Maximum Watts Square Wave.
6.	Resonant Frequency	<b>850</b> $\pm 20 \%$ Hz.	
7.	Output Sound Pressure Level (S.P.L.)	<b>82</b> $\pm 3$ db/ <b>0.5</b> Watt $\cdot$ 0.5 Meter	
		Average at <b>800, 1000, 1200, 1500</b> Hz.	
8.	Frequency Range	<b>500</b> $\sim$ <b>9000</b> Hz. Average SPL – 10 db.	
9.	Distortion	<b>5</b> % Maximum At <b>1000</b> Hz. <b>0.5</b> W.	
10	Abnormal Sound test	Must be Normal Tested By <b>2.0</b> Volts. Sine Wave.	
11	Load Test	White Noise <b>2.0</b> Volts. (RMS.) <b>96</b> Hours.	
12	Polarity	Diaphragm shall move Forward while Apply a Positive DC Signal to the " + " or " Marked " Terminal.	

Above Measuring condition under temperature : 25~35 $^{\circ}$ C R.H. 25 ~75%. According to standard GB/T9396-1996

## **Mechanical and vibration test**

13	High Temperature	+ 85 $\pm$ 2 $^{\circ}$ C	Humidity Random for 96 Hours. (GB2423.2-81)
14	Low Temperature	- 40 $\pm$ 2 $^{\circ}$ C	Humidity Random for 96 Hours. (GB2423.1-81)
15	Humidity	+ 40 $\pm$ 2 $^{\circ}$ C	Relative Humidity (RH) 90 ~ 95 % 96 Hours.
16	Vibration	Frequency 30 $\pm$ 15 Hz, Amplitude 1.5 mm for 3 Hours. (GB11606.8-89)	
17	Drop test	75 CM free falling on Concrete floor, 10 times. (GB2423. 8-81)	
After test leave speakers at room temperature for 1 hour, SPL shall not deviate by $\pm$ 3 db from pre-test			
18	Temperature Cycle test	- 40 ~ + 85 $^{\circ}$ C	4 Cycles Temperature test. (GB5170.18-87)

After test leave speakers at room temperature for 1 hour, SPL shall not deviate by  $\pm$  4 db from pre-test Measurement, and meet above spec. item 6. 7. 8. 9. 10.

Please refer to next pages for more detailed testing method.

## Test method and User precaution.

1. Characteristics measured according to standard GB/T 9396-1996
  - 1.1 Except other specified, measuring are under Temperature 25~35°C R.H. 25 ~75%
  - 1.2. Judgement condition Temperature 20 ±2 R.H. 63~67%
2. Output Sound Pressure Level (S.P.L.) and distortion testing setup

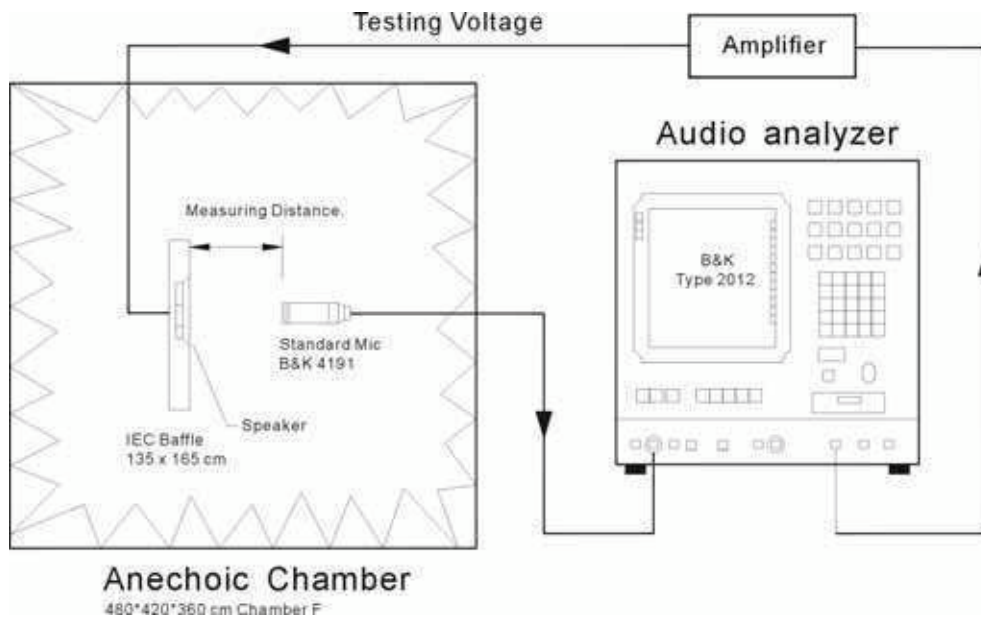

### 3. Environment & Mechanical test:

#### 3.1 High Temperature: GB2423.2-81

After exposure the speaker in the + 85 ± 2 °C chamber for 96 hours, then leave the speaker at room temperature for 1 hour, the SPL should not deviate by ± 3 db, and resonant frequency should not deviate by ± 50 Hz, compare with pre-test measurement.

#### 3.2 Low Temperature: GB2423.1-81

After exposure the speaker in the -40 ± 2 °C chamber for 96 hours, then leave the speaker at room temperature for 1 hour, the SPL should not deviate by ± 3 db, and resonant frequency should not deviate by ± 50 Hz, compare with pre-test measurement.

#### 3.3 Temperature cycle: GB5170.18-87

After exposure the speaker in the chamber, temperature cycle setting as below shows, SPL should not deviate by ± 4 db, and resonant frequency should not deviate by ± 80 Hz, compare with pre-test measurement.

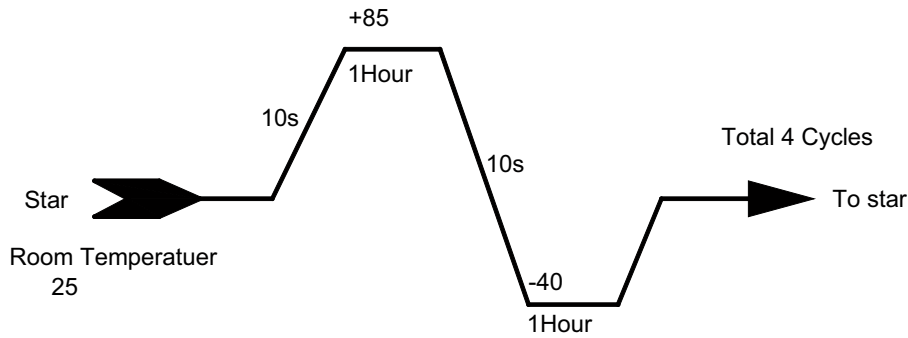

### 3.4 Humidity: GB5170.18-87

After exposure the speaker in the  $+40 \pm 2$  °C, relative humidity 90% ~ 95% chamber for 96 hours, then leave the speaker at room temperature for 6 hours, the SPL should not deviate by  $\pm 3$  db, and resonant frequency should not deviate by  $\pm 50$  Hz, compare with pre-test measurement.

### 3.5 Vibration: GB11606.8-89

Frequency  $30 \pm 15$  Hz, Amplitude 1.5 mm for 3 Hours. After test, SPL shall not deviate by  $\pm 3$  db from pre-test measurement,

### 3.6 Load test: GB/T 9396-1996

Speaker should not fail after apply 20 ~ 20K Hz white noise rated power input (RMS), 96 hours. After test, SPL shall not deviate by  $\pm 3$  db from pre-test measurement,

### 3.7 Drop test: GB2423. 8-81

75 cm free falling on concrete floor, 10 times. After test, SPL shall not deviate by  $\pm 3$  db from pre-test measurement,

## 4. Mounting **precaution**

In order to keep speaker work normally, there shall leave enough free space for diaphragm moving, minimum distance required is marked in speaker mechanical drawing.

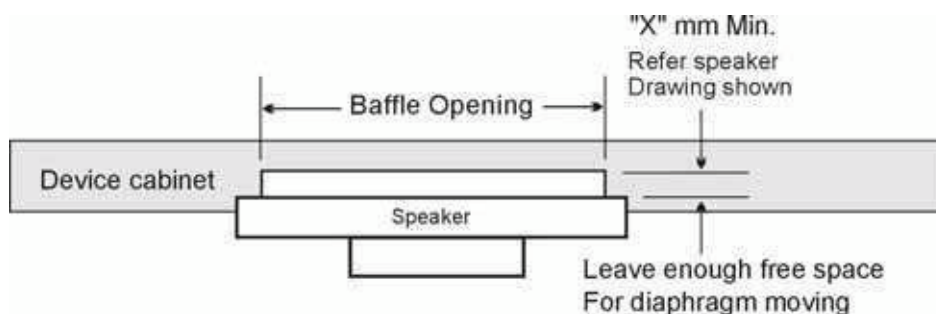

## 5. Measuring & standard referenced

Abstract from GB/T 9396-1996 and IEC 268-5:1989 methods of measurement for main characteristics of loud speakers.

### 5.1 Maximum input voltage

Maximum input voltage is in the shortest time. The speaker can bear simulation signal, that persist time is 1 second, interval 60 seconds, repeated 60 times, but the speaker wouldn't be damaged externally. The maximum signal voltage is the maximum input voltage in/the shortest time.

### 5.2 Rated sine voltage.

It is stipulated by manufacturer, sine signal voltage that make speaker work continuously in rated frequency range, but the speaker wouldn't be damaged heartily or mechanically. The persist time of the voltage is 1 hour.

### 5.3 The shortest time maximum power.

It is corresponding with the shortest time maximum input voltage, its definition is  $U_{st}^2/R$ ,  $U_{st}$  indicates the shortest input power, R indicates the rated impedance.

### 5.4 The long time maximum power.

The long time maximum power is corresponding with the long time maximum input voltage, Its definition is  $U_{lt}^2/R$ ,  $U_{lt}$  indicates the long time maximum input voltage, R indicates the rated impedance.

### 5.5 The rated sine power.

The rated sine power is corresponding with the rated sine voltage, its definition is  $U_s^2/R$ ,  $U_s$  indicates the maximum sin voltage, R indicates the rated impedance.

### 5.6 The rated noise power.

The rated noise power is corresponding with the rated noise voltage, its definition is  $U_n^2/R$ ,  $U_n$  indicates the rated noise voltage, R indicates the rated impedance.

20CS08F-1-E50ND/NT VOL:2.0V(0.5W) DIS:0.5M VANSONIC  
X:1.0000kHz \*Y:83.20dB ZA:Live Curve SSR Fund.

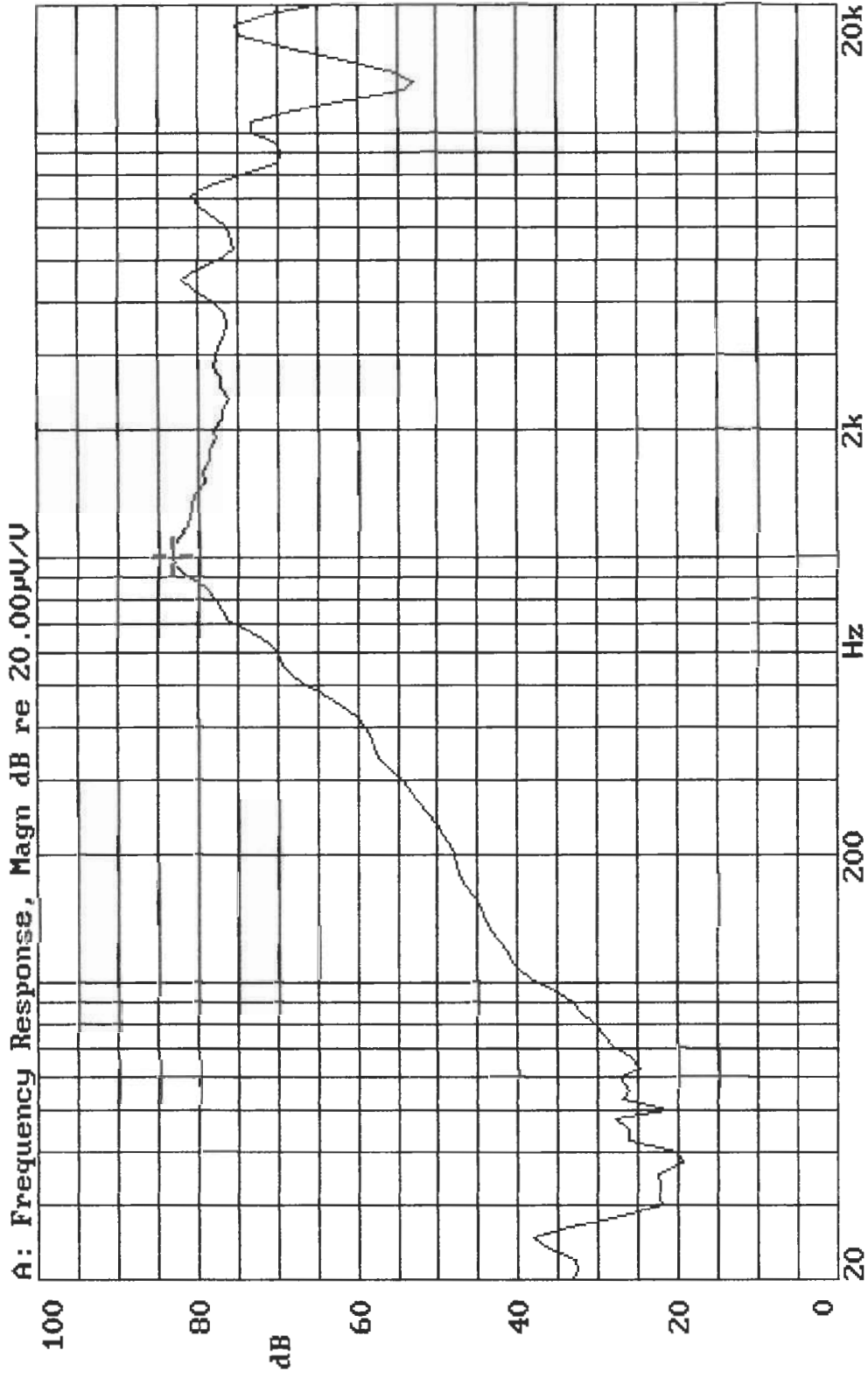

09-APR-2002 18:35:38

Mode: SSR

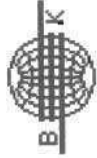

# MOUNTING NOTICE

1.8±0.3

1.0±0.3

At Least

0.5

For  
Diaphragm  
Moving

Baffle Opening

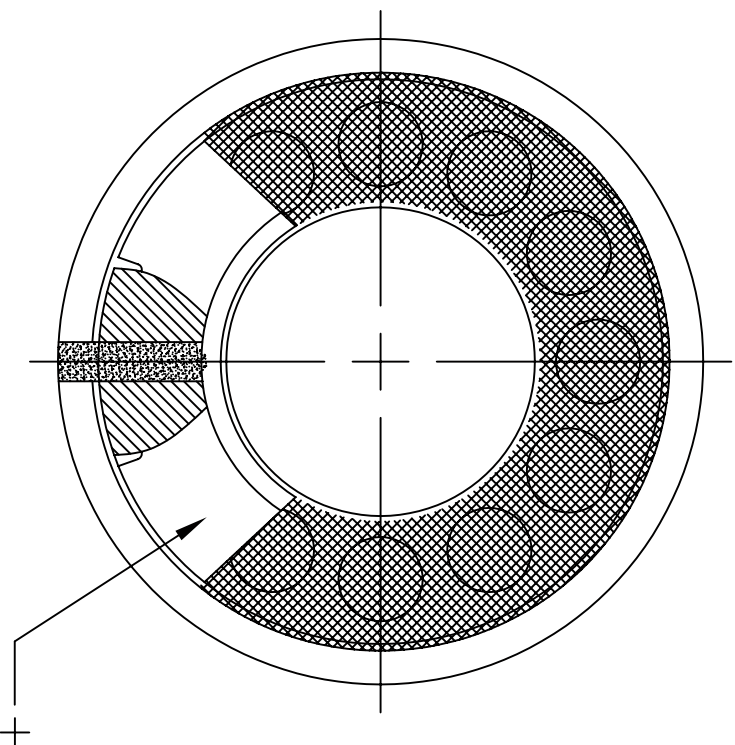
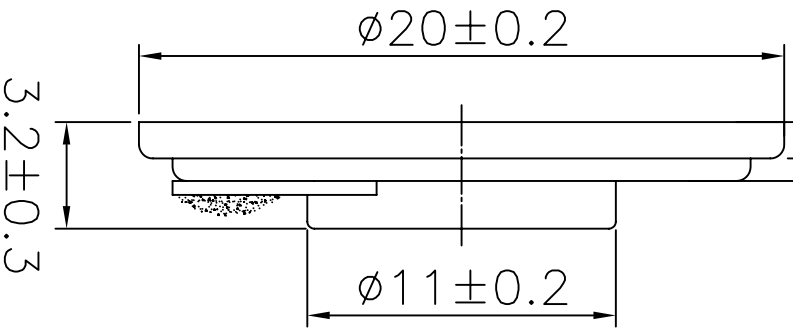
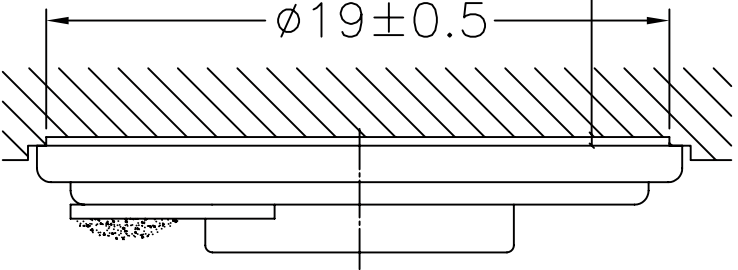

Foshan Vanson Enterprise CO., Ltd.

宏立電子

E-MAIL: VECOF@FS165.COM  
TEL: +86-757-83815788 FAX: +86-757-83818577

Title: P20CS08F-1-E50ND

F:\SPEC\THIN\20CF\P20CS08F-1-E50ND.DWG

VERSION	DATE	DESCRIPTION
V1.0	06.03.23	

Unit: mm	Scale:	Appr.: 高紅華
Tol.: 其餘±1/2IT13		CHK.: 劉雲華
		Dwg.: 廖繼茂