

XLamp® XP-G4 LEDs

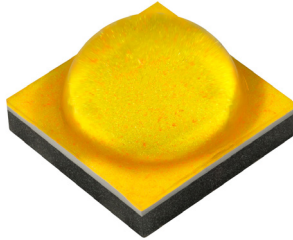

XP-G4 Standard

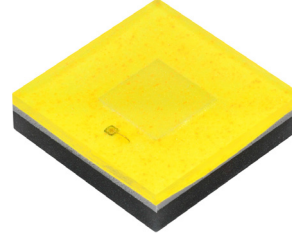

XP-G4 High Intensity

PRODUCT DESCRIPTION

XLamp® XP-G4 LEDs are the fourth generation of Cree LED's standard-setting XP-G product family, featuring both best-in-class efficacy and optical performance. New features in this generation include a higher maximum drive current of 3000 mA and an optimized optical profile that maximizes on-axis light output.

With the same mechanical dimensions as XP-G3, the XP-G4 is an easy upgrade path for many high-power LED designs. XP-G4 provides higher maximum current and lower thermal resistance than competing high-power LEDs, enabling new levels of output and reliability for many lighting applications.

XLamp XP-G4 LEDs are optimized for a wide range of directional lighting applications where light control and long lifetime are critical, including outdoor, indoor premium, architectural, portable and entertainment.

In this document, the term White denotes the white XP-G4 LED without regard to its Standard or High Intensity (HI) features. The terms Standard and HI are used when necessary to differentiate the performance of the Standard XP-G4 LED from the HI XP-G4 LED.

FEATURES

- Available in no CRI minimum white, 70-, 80- and 90-CRI white
- ANSI-compatible chromaticity bins
- Broadcast color option at 5700 K provides maximum performance for TV events that require extremely high TLCI
- 3-step and 5-step options
- Binned at 85 °C
- Maximum drive current: 3000 mA
- Low thermal resistance: 1.3 °C/W
- Wide viewing angle: 120° - 125°
- Unlimited floor life at ≤ 30 °C/85% RH
- Reflow solderable - JEDEC J-STD-020C
- Electrically neutral thermal path
- RoHS and REACH compliant
- UL® recognized component (E349212)



Cree LED / 4001 E. Hwy. 54, Suite 2000 / Durham, NC 27709 USA / +1.919.313.5330 / www.cree-led.com

TABLE OF CONTENTS

Characteristics	3
Flux Characteristics - Standard	4
Flux Characteristics - High Intensity	17
Flux Characteristics - Broadcast Order Codes and Bins	29
Relative Spectral Power Distribution	30
Relative Flux vs. Junction Temperature	31
Electrical Characteristics	32
Relative Luminous Flux vs. Current	33
Relative Chromaticity vs. Current and Temperature	34
Typical Spatial Distribution	36
Thermal Design	37
Performance Groups - Luminous Flux	38
Performance Groups - Chromaticity	39
Cree LED’s Standard Cool White Kits Plotted on ANSI Standard Chromaticity Regions	43
Cree LED’s Standard Warm and Neutral White Kits Plotted on ANSI Standard Chromaticity Regions	44
Cree LED’s EasyWhite® White Kits Plotted on ANSI Standard Chromaticity Regions	45
Cree LED’s Standard Chromaticity Kits	46
Bin and Order Code Formats	47
Reflow Soldering Characteristics	48
Notes	49
Mechanical Dimensions	51
Tape and Reel	54
Packaging	56

CHARACTERISTICS

Characteristics	Unit	Minimum	Typical	Maximum
Thermal resistance, junction to solder point ⁹	°C/W		1.3	
Viewing angle (FWHM) - Standard	degrees		120	
Viewing angle (FWHM) - High Intensity	degrees		125	
Temperature coefficient of voltage	mV/°C		-1.3	
ESD withstand voltage (HBM per Mil-Std-883D)			Class 3B	
DC forward current	mA			3000
Reverse voltage	V			5
Forward voltage (@ 700 mA, 85 °C)	V		2.8	3.3
Forward voltage (@ 1000 mA, 85 °C) - Standard	V		2.92	
Forward voltage (@ 1050 mA, 85 °C) - High Intensity	V		2.88	
Forward voltage (@ 2000 mA, 85 °C) - Standard	V		3.14	
Forward voltage (@ 2000 mA, 85 °C) - High Intensity	V		3.07	
Forward voltage (@ 3000 mA, 85 °C) - Standard	V		3.32	
Forward voltage (@ 3000 mA, 85 °C) - High Intensity	V		3.23	
CRI R9 (70 CRI minimum)		-40		
CRI R9 (80 CRI minimum)		0		
CRI R9 (90 CRI minimum)		50		
LED junction temperature	°C			150

Note:

- ◇ Thermal resistance measurement was performed per the JEDEC JESD51-14 standard. See the [Thermal Resistance Measurement application note](#) for more details.

FLUX CHARACTERISTICS - STANDARD (T_j = 85 °C)

The following table provides order codes for XLamp XP-G4 Standard LEDs. For a complete description of the order code nomenclature, please see the Bin and Order Code Formats section (page 47). For definitions of the chromaticity kits, please see the Cree LED's Standard Chromaticity Kits section (page 46).

Chromaticity		Minimum Luminous Flux (lm) @ 700 mA			Order Codes			
Kit	CCT	Code	Flux (lm) @ 85 °C	Flux (lm) @ 25 °C*	70 CRI Typical	70 CRI Minimum	80 CRI Minimum	90 CRI Minimum
DT	7000 K	C5	340	371	XPGEWT-01-0000-00000QDT	XPGEWT-01-0000-00000BQDT		
		C4	330	360	XPGEWT-01-0000-00000PDT	XPGEWT-01-0000-00000BPDT		
		C3	320	349	XPGEWT-01-0000-00000NDT	XPGEWT-01-0000-00000BNDT	XPGEWT-01-0000-00000HNDT	
		C2	310	338		XPGEWT-01-0000-00000BMDT	XPGEWT-01-0000-00000HMDT	
		C1	300	327			XPGEWT-01-0000-00000HLDT	
		B5	290	316			XPGEWT-01-0000-00000HKDT	
E0	>6500 K	C5	340	371		XPGEWT-01-0000-00000BQEO		
		C4	330	360		XPGEWT-01-0000-00000BPEO		
		C3	320	349		XPGEWT-01-0000-00000BNEO		
		C2	310	338			XPGEWT-01-0000-00000HME0	
		C1	300	327			XPGEWT-01-0000-00000HLE0	
		B5	290	316			XPGEWT-01-0000-00000HKE0	
E1	6500 K	D1	350	382	XPGEWT-01-0000-00000RE1	XPGEWT-01-0000-00000BRE1		
		C5	340	371	XPGEWT-01-0000-00000QE1	XPGEWT-01-0000-00000BQE1		
		C4	330	360	XPGEWT-01-0000-00000PE1	XPGEWT-01-0000-00000BPE1		
		C3	320	349			XPGEWT-01-0000-00000HNE1	
		C2	310	338			XPGEWT-01-0000-00000HME1	
		C1	300	327			XPGEWT-01-0000-00000HLE1	
		B5	290	316			XPGEWT-01-0000-00000HKE1	

Notes

- Cree LED maintains a tolerance of ±7% on flux and power measurements, ±0.005 on chromaticity (CCx, CCy) measurements and a tolerance of ±2 on CRI measurements. See the Measurements section (page 49).
- XLamp XP-G4 LED order codes specify only a minimum flux bin and not a maximum. Cree LED may ship reels in flux bins higher than the minimum specified by the order code without advance notice. Shipments will always adhere to the chromaticity bin restrictions specified by the order code.
- * Flux values @ 25 °C are calculated and for reference only.

FLUX CHARACTERISTICS - STANDARD (T_j = 85 °C) - CONTINUED

Chromaticity		Minimum Luminous Flux (lm) @ 700 mA			Order Codes			
Kit	CCT	Code	Flux (lm) @ 85 °C	Flux (lm) @ 25 °C*	70 CRI Typical	70 CRI Minimum	80 CRI Minimum	90 CRI Minimum
DV	6000 K	D1	350	382	XPGEWT-01-0000-000000RDV	XPGEWT-01-0000-000000BRDV		
		C5	340	371	XPGEWT-01-0000-000000QDV	XPGEWT-01-0000-000000BQDV		
		C4	330	360	XPGEWT-01-0000-000000PDV	XPGEWT-01-0000-000000BPDV		
		C3	320	349			XPGEWT-01-0000-000000HNDV	
		C2	310	338			XPGEWT-01-0000-000000HMDV	
		C1	300	327			XPGEWT-01-0000-000000HLDV	
		B5	290	316			XPGEWT-01-0000-000000HKDV	
50	6000 K	D1	350	382	XPGEWT-01-0000-000000R50	XPGEWT-01-0000-000000BR50		
		C5	340	371	XPGEWT-01-0000-000000Q50	XPGEWT-01-0000-000000BQ50		
		C4	330	360	XPGEWT-01-0000-000000P50	XPGEWT-01-0000-000000BP50		
		C3	320	349			XPGEWT-01-0000-000000HN50	
		C2	310	338			XPGEWT-01-0000-000000HM50	
		C1	300	327			XPGEWT-01-0000-000000HL50	
		B5	290	316			XPGEWT-01-0000-000000HK50	

Notes

- Cree LED maintains a tolerance of ±7% on flux and power measurements, ±0.005 on chromaticity (CCx, CCy) measurements and a tolerance of ±2 on CRI measurements. See the Measurements section (page 49).
- XLamp XP-G4 LED order codes specify only a minimum flux bin and not a maximum. Cree LED may ship reels in flux bins higher than the minimum specified by the order code without advance notice. Shipments will always adhere to the chromaticity bin restrictions specified by the order code.
- * Flux values @ 25 °C are calculated and for reference only.

FLUX CHARACTERISTICS - STANDARD (T_j = 85 °C) - CONTINUED

Chromaticity		Minimum Luminous Flux (lm) @ 700 mA			Order Codes			
Kit	CCT	Code	Flux (lm) @ 85 °C	Flux (lm) @ 25 °C*	70 CRI Typical	70 CRI Minimum	80 CRI Minimum	90 CRI Minimum
2E	5700 K	D1	350	382		XPGEWT-01-0000-00000BR2E		
		C5	340	371		XPGEWT-01-0000-00000BQ2E		
		C4	330	360		XPGEWT-01-0000-00000BP2E		
		C3	320	349			XPGEWT-01-0000-00000HN2E	
		C2	310	338			XPGEWT-01-0000-00000HM2E	
		C1	300	327			XPGEWT-01-0000-00000HL2E	
		B5	290	316				
		B4	280	305				XPGEWT-01-0000-00000UJ2E
		B3	270	294				XPGEWT-01-0000-00000UH2E
		B2	260	284				XPGEWT-01-0000-00000UG2E
E2	5700 K	D1	350	382	XPGEWT-01-0000-00000RE2	XPGEWT-01-0000-00000BRE2		
		C5	340	371	XPGEWT-01-0000-00000QE2	XPGEWT-01-0000-00000BQE2		
		C4	330	360	XPGEWT-01-0000-00000PE2	XPGEWT-01-0000-00000BPE2		
		C3	320	349		XPGEWT-01-0000-00000BNE2	XPGEWT-01-0000-00000HNE2	
		C2	310	338			XPGEWT-01-0000-00000HME2	
		C1	300	327			XPGEWT-01-0000-00000HLE2	
		B5	290	316			XPGEWT-01-0000-00000HKE2	
		B4	280	305				XPGEWT-01-0000-00000UJE2
		B3	270	294				XPGEWT-01-0000-00000UHE2
		B2	260	284				XPGEWT-01-0000-00000UGE2

Notes

- Cree LED maintains a tolerance of ±7% on flux and power measurements, ±0.005 on chromaticity (CCx, CCy) measurements and a tolerance of ±2 on CRI measurements. See the Measurements section (page 49).
- XLamp XP-G4 LED order codes specify only a minimum flux bin and not a maximum. Cree LED may ship reels in flux bins higher than the minimum specified by the order code without advance notice. Shipments will always adhere to the chromaticity bin restrictions specified by the order code.
- * Flux values @ 25 °C are calculated and for reference only.

FLUX CHARACTERISTICS - STANDARD (T_j = 85 °C) - CONTINUED

Chromaticity		Minimum Luminous Flux (lm) @ 700 mA			Order Codes			
Kit	CCT	Code	Flux (lm) @ 85 °C	Flux (lm) @ 25 °C*	70 CRI Typical	70 CRI Minimum	80 CRI Minimum	90 CRI Minimum
3E	5000 K	D2	360	393		XPGEWT-01-0000-00000BS3E		
		D1	350	382		XPGEWT-01-0000-00000BR3E		
		C5	340	371		XPGEWT-01-0000-00000BQ3E		
		C4	330	360		XPGEWT-01-0000-00000BP3E		
		C3	320	349			XPGEWT-01-0000-00000HN3E	
		C2	310	338			XPGEWT-01-0000-00000HM3E	
		C1	300	327			XPGEWT-01-0000-00000HL3E	
		B5	290	316				
		B4	280	305				XPGEWT-01-0000-00000UJ3E
		B3	270	294				XPGEWT-01-0000-00000UH3E
		B2	260	284				XPGEWT-01-0000-00000UG3E
E3	5000 K	D2	360	393	XPGEWT-01-0000-00000SE3	XPGEWT-01-0000-00000BSE3		
		D1	350	382	XPGEWT-01-0000-00000RE3	XPGEWT-01-0000-00000BRE3		
		C5	340	371	XPGEWT-01-0000-00000QE3	XPGEWT-01-0000-00000BQE3		
		C4	330	360	XPGEWT-01-0000-00000PE3	XPGEWT-01-0000-00000BPE3		
		C3	320	349			XPGEWT-01-0000-00000HNE3	
		C2	310	338			XPGEWT-01-0000-00000HME3	
		C1	300	327			XPGEWT-01-0000-00000HLE3	
		B5	290	316				
		B4	280	305				XPGEWT-01-0000-00000UJE3
		B3	270	294				XPGEWT-01-0000-00000UHE3
		B2	260	284				XPGEWT-01-0000-00000UGE3

Notes

- Cree LED maintains a tolerance of ±7% on flux and power measurements, ±0.005 on chromaticity (CCx, CCy) measurements and a tolerance of ±2 on CRI measurements. See the Measurements section (page 49).
- XLamp XP-G4 LED order codes specify only a minimum flux bin and not a maximum. Cree LED may ship reels in flux bins higher than the minimum specified by the order code without advance notice. Shipments will always adhere to the chromaticity bin restrictions specified by the order code.
- * Flux values @ 25 °C are calculated and for reference only.

FLUX CHARACTERISTICS - STANDARD (T_j = 85 °C) - CONTINUED

Chromaticity		Minimum Luminous Flux (lm) @ 700 mA			Order Codes			
Kit	CCT	Code	Flux (lm) @ 85 °C	Flux (lm) @ 25 °C*	70 CRI Typical	70 CRI Minimum	80 CRI Minimum	90 CRI Minimum
F4	4750 K	D1	350	382	XPGEWT-01-0000-000000RF4	XPGEWT-01-0000-000000BRF4		
		C5	340	371	XPGEWT-01-0000-000000QF4	XPGEWT-01-0000-000000BQF4		
		C4	330	360	XPGEWT-01-0000-000000PF4	XPGEWT-01-0000-000000BPF4		
		C3	320	349			XPGEWT-01-0000-000000HNF4	
		C2	310	338			XPGEWT-01-0000-000000HMF4	
		C1	300	327			XPGEWT-01-0000-000000HLF4	
		B5	290	316				
		B4	280	305				
		B3	270	294				XPGEWT-01-0000-000000UHF4
		B2	260	284				XPGEWT-01-0000-000000UGF4
4E	4500K	D1	350	382		XPGEWT-01-0000-000000BR4E		
		C5	340	371		XPGEWT-01-0000-000000BQ4E		
		C4	330	360		XPGEWT-01-0000-000000BP4E		
		C3	320	349			XPGEWT-01-0000-000000HN4E	
		C2	310	338			XPGEWT-01-0000-000000HM4E	
		C1	300	327			XPGEWT-01-0000-000000HL4E	
		B5	290	316				
		B4	280	305				
		B3	270	294				XPGEWT-01-0000-000000UH4E
		B2	260	284				XPGEWT-01-0000-000000UG4E

Notes

- Cree LED maintains a tolerance of ±7% on flux and power measurements, ±0.005 on chromaticity (CCx, CCy) measurements and a tolerance of ±2 on CRI measurements. See the Measurements section (page 49).
- XLamp XP-G4 LED order codes specify only a minimum flux bin and not a maximum. Cree LED may ship reels in flux bins higher than the minimum specified by the order code without advance notice. Shipments will always adhere to the chromaticity bin restrictions specified by the order code.
- * Flux values @ 25 °C are calculated and for reference only.

FLUX CHARACTERISTICS - STANDARD (T_j = 85 °C) - CONTINUED

Chromaticity		Minimum Luminous Flux (lm) @ 700 mA			Order Codes				
Kit	CCT	Code	Flux (lm) @ 85 °C	Flux (lm) @ 25 °C*	70 CRI Typical	70 CRI Minimum	80 CRI Minimum	90 CRI Minimum	
E4	4500 K	D1	350	382	XPGEWT-01-0000-000000RE4	XPGEWT-01-0000-000000BRE4			
		C5	340	371	XPGEWT-01-0000-000000QE4	XPGEWT-01-0000-000000BQE4			
		C4	330	360	XPGEWT-01-0000-000000PE4	XPGEWT-01-0000-000000BPE4			
		C3	320	349			XPGEWT-01-0000-000000HNE4		
		C2	310	338			XPGEWT-01-0000-000000HME4		
		C1	300	327			XPGEWT-01-0000-000000HLE4		
		B5	290	316					
		B4	280	305					
		B3	270	294					XPGEWT-01-0000-000000UHE4
		B2	260	284					XPGEWT-01-0000-000000UGE4
F5	4200 K	D1	350	382	XPGEWT-01-0000-000000RF5	XPGEWT-01-0000-000000BRF5			
		C5	340	371	XPGEWT-01-0000-000000QF5	XPGEWT-01-0000-000000BQF5			
		C4	330	360	XPGEWT-01-0000-000000PF5	XPGEWT-01-0000-000000BPF5			
		C3	320	349			XPGEWT-01-0000-000000HNF5		
		C2	310	338			XPGEWT-01-0000-000000HMF5		
		C1	300	327			XPGEWT-01-0000-000000HLF5		
		B5	290	316			XPGEWT-01-0000-000000HKF5		
		B4	280	305					
		B3	270	294					XPGEWT-01-0000-000000UHF5
		B2	260	284					XPGEWT-01-0000-000000UGF5

Notes

- Cree LED maintains a tolerance of ±7% on flux and power measurements, ±0.005 on chromaticity (CCx, CCy) measurements and a tolerance of ±2 on CRI measurements. See the Measurements section (page 49).
- XLamp XP-G4 LED order codes specify only a minimum flux bin and not a maximum. Cree LED may ship reels in flux bins higher than the minimum specified by the order code without advance notice. Shipments will always adhere to the chromaticity bin restrictions specified by the order code.
- * Flux values @ 25 °C are calculated and for reference only.

FLUX CHARACTERISTICS - STANDARD (T_j = 85 °C) - CONTINUED

Chromaticity		Minimum Luminous Flux (lm) @ 700 mA			Order Codes			
Kit	CCT	Code	Flux (lm) @ 85 °C	Flux (lm) @ 25 °C*	70 CRI Typical	70 CRI Minimum	80 CRI Minimum	90 CRI Minimum
5E	4000 K	D1	350	382		XPGEWT-01-0000-00000BR5E		
		C5	340	371		XPGEWT-01-0000-00000BQ5E		
		C4	330	360		XPGEWT-01-0000-00000BP5E		
		C3	320	349			XPGEWT-01-0000-00000HN5E	
		C2	310	338			XPGEWT-01-0000-00000HM5E	
		C1	300	327			XPGEWT-01-0000-00000HL5E	
		B5	290	316			XPGEWT-01-0000-00000HK5E	
		B4	280	305				
		B3	270	294				XPGEWT-01-0000-00000UH5E
		B2	260	284				XPGEWT-01-0000-00000UG5E
E5	4000 K	D1	350	382	XPGEWT-01-0000-00000RE5	XPGEWT-01-0000-00000BRE5		
		C5	340	371	XPGEWT-01-0000-00000QE5	XPGEWT-01-0000-00000BQE5		
		C4	330	360	XPGEWT-01-0000-00000PE5	XPGEWT-01-0000-00000BPE5		
		C3	320	349			XPGEWT-01-0000-00000HNE5	
		C2	310	338			XPGEWT-01-0000-00000HME5	
		C1	300	327			XPGEWT-01-0000-00000HLE5	
		B5	290	316			XPGEWT-01-0000-00000HKE5	
		B4	280	305				
		B3	270	294				XPGEWT-01-0000-00000UHE5
		B2	260	284				XPGEWT-01-0000-00000UGE5

Notes

- Cree LED maintains a tolerance of ±7% on flux and power measurements, ±0.005 on chromaticity (CCx, CCy) measurements and a tolerance of ±2 on CRI measurements. See the Measurements section (page 49).
- XLamp XP-G4 LED order codes specify only a minimum flux bin and not a maximum. Cree LED may ship reels in flux bins higher than the minimum specified by the order code without advance notice. Shipments will always adhere to the chromaticity bin restrictions specified by the order code.
- * Flux values @ 25 °C are calculated and for reference only.

FLUX CHARACTERISTICS - STANDARD (T_j = 85 °C) - CONTINUED

Chromaticity		Minimum Luminous Flux (lm) @ 700 mA			Order Codes			
Kit	CCT	Code	Flux (lm) @ 85 °C	Flux (lm) @ 25 °C*	70 CRI Typical	70 CRI Minimum	80 CRI Minimum	90 CRI Minimum
F6	3700 K	C5	340	371	XPGEWT-01-0000-000000QF6	XPGEWT-01-0000-00000BQF6		
		C4	330	360	XPGEWT-01-0000-000000PF6	XPGEWT-01-0000-00000BPF6		
		C3	320	349	XPGEWT-01-0000-000000NF6	XPGEWT-01-0000-00000BNF6		
		C2	310	338			XPGEWT-01-0000-00000HMF6	
		C1	300	327			XPGEWT-01-0000-00000HLF6	
		B5	290	316			XPGEWT-01-0000-00000HKF6	
		B4	280	305				
		B3	270	294				
		B2	260	284				XPGEWT-01-0000-00000UGF6
		B1	250	273				XPGEWT-01-0000-00000UFF6
6E	3500 K	C5	340	371		XPGEWT-01-0000-00000BQ6E		
		C4	330	360		XPGEWT-01-0000-00000BP6E		
		C3	320	349		XPGEWT-01-0000-00000BN6E		
		C2	310	338			XPGEWT-01-0000-00000HM6E	
		C1	300	327			XPGEWT-01-0000-00000HL6E	
		B5	290	316			XPGEWT-01-0000-00000HK6E	
		B4	280	305				
		B3	270	294				
		B2	260	284				XPGEWT-01-0000-00000UG6E
		B1	250	273				XPGEWT-01-0000-00000UF6E
6G	3500 K	B2	260	284				XPGEWT-01-0000-00000UG6G
		B1	250	273				XPGEWT-01-0000-00000UF6G

Notes

- Cree LED maintains a tolerance of ±7% on flux and power measurements, ±0.005 on chromaticity (CCx, CCy) measurements and a tolerance of ±2 on CRI measurements. See the Measurements section (page 49).
- XLamp XP-G4 LED order codes specify only a minimum flux bin and not a maximum. Cree LED may ship reels in flux bins higher than the minimum specified by the order code without advance notice. Shipments will always adhere to the chromaticity bin restrictions specified by the order code.
- * Flux values @ 25 °C are calculated and for reference only.

FLUX CHARACTERISTICS - STANDARD (T_j = 85 °C) - CONTINUED

Chromaticity		Minimum Luminous Flux (lm) @ 700 mA			Order Codes				
Kit	CCT	Code	Flux (lm) @ 85 °C	Flux (lm) @ 25 °C*	70 CRI Typical	70 CRI Minimum	80 CRI Minimum	90 CRI Minimum	
E6	3500 K	C5	340	371	XPGEWT-01-0000-000000QE6	XPGEWT-01-0000-000000BQE6			
		C4	330	360	XPGEWT-01-0000-000000PE6	XPGEWT-01-0000-000000BPE6			
		C3	320	349	XPGEWT-01-0000-000000NE6	XPGEWT-01-0000-000000BNE6			
		C2	310	338			XPGEWT-01-0000-000000HME6		
		C1	300	327			XPGEWT-01-0000-000000HLE6		
		B5	290	316			XPGEWT-01-0000-000000HKE6		
		B4	280	305					
		B3	270	294					
		B2	260	284					XPGEWT-01-0000-000000UGE6
		B1	250	273					XPGEWT-01-0000-000000UFE6
F7	3200K	C5	340	371	XPGEWT-01-0000-000000QF7	XPGEWT-01-0000-000000BQF7			
		C4	330	360	XPGEWT-01-0000-000000PF7	XPGEWT-01-0000-000000BPF7			
		C3	320	349	XPGEWT-01-0000-000000NF7	XPGEWT-01-0000-000000BNF7			
		C2	310	338	XPGEWT-01-0000-000000MF7	XPGEWT-01-0000-000000BMF7			
		C1	300	327			XPGEWT-01-0000-000000HLF7		
		B5	290	316			XPGEWT-01-0000-000000HKF7		
		B4	280	305			XPGEWT-01-0000-000000HJF7		
		B3	270	294			XPGEWT-01-0000-000000HHF7		
		B2	260	284					
		B1	250	273					XPGEWT-01-0000-000000UFF7
		A5	240	262					XPGEWT-01-0000-000000UEF7
		A4	230	251					XPGEWT-01-0000-000000UDF7

Notes

- Cree LED maintains a tolerance of ±7% on flux and power measurements, ±0.005 on chromaticity (CCx, CCy) measurements and a tolerance of ±2 on CRI measurements. See the Measurements section (page 49).
- XLamp XP-G4 LED order codes specify only a minimum flux bin and not a maximum. Cree LED may ship reels in flux bins higher than the minimum specified by the order code without advance notice. Shipments will always adhere to the chromaticity bin restrictions specified by the order code.
- * Flux values @ 25 °C are calculated and for reference only.

FLUX CHARACTERISTICS - STANDARD (T_j = 85 °C) - CONTINUED

Chromaticity		Minimum Luminous Flux (lm) @ 700 mA			Order Codes				
Kit	CCT	Code	Flux (lm) @ 85 °C	Flux (lm) @ 25 °C*	70 CRI Typical	70 CRI Minimum	80 CRI Minimum	90 CRI Minimum	
7E	3000 K	C5	340	371		XPGEWT-01-0000-00000BQ7E			
		C4	330	360		XPGEWT-01-0000-00000BP7E			
		C3	320	349		XPGEWT-01-0000-00000BN7E			
		C2	310	338		XPGEWT-01-0000-00000BM7E			
		C1	300	327			XPGEWT-01-0000-00000HL7E		
		B5	290	316			XPGEWT-01-0000-00000HK7E		
		B4	280	305			XPGEWT-01-0000-00000HJ7E		
		B3	270	294			XPGEWT-01-0000-00000HH7E		
		B2	260	284					
		B1	250	273					XPGEWT-01-0000-00000UF7E
		A5	240	262					XPGEWT-01-0000-00000UE7E
		A4	230	251					XPGEWT-01-0000-00000UD7E
7G	3000 K	B1	250	273				XPGEWT-01-0000-00000UF7G	
		A5	240	262				XPGEWT-01-0000-00000UE7G	
		A4	230	251				XPGEWT-01-0000-00000UD7G	

Notes

- Cree LED maintains a tolerance of ±7% on flux and power measurements, ±0.005 on chromaticity (CCx, CCy) measurements and a tolerance of ±2 on CRI measurements. See the Measurements section (page 49).
- XLamp XP-G4 LED order codes specify only a minimum flux bin and not a maximum. Cree LED may ship reels in flux bins higher than the minimum specified by the order code without advance notice. Shipments will always adhere to the chromaticity bin restrictions specified by the order code.
- * Flux values @ 25 °C are calculated and for reference only.

FLUX CHARACTERISTICS - STANDARD (T_j = 85 °C) - CONTINUED

Chromaticity		Minimum Luminous Flux (lm) @ 700 mA			Order Codes				
Kit	CCT	Code	Flux (lm) @ 85 °C	Flux (lm) @ 25 °C*	70 CRI Typical	70 CRI Minimum	80 CRI Minimum	90 CRI Minimum	
E7	3000 K	C5	340	371	XPGEWT-01-0000-000000QE7	XPGEWT-01-0000-000000BQE7			
		C4	330	360	XPGEWT-01-0000-000000PE7	XPGEWT-01-0000-000000BPE7			
		C3	320	349	XPGEWT-01-0000-000000NE7	XPGEWT-01-0000-000000BNE7			
		C2	310	338	XPGEWT-01-0000-000000ME7	XPGEWT-01-0000-000000BME7			
		C1	300	327			XPGEWT-01-0000-000000HLE7		
		B5	290	316			XPGEWT-01-0000-000000HKE7		
		B4	280	305			XPGEWT-01-0000-000000HJE7		
		B3	270	294			XPGEWT-01-0000-000000HHE7		
		B2	260	284					
		B1	250	273					XPGEWT-01-0000-000000UFE7
		A5	240	262					XPGEWT-01-0000-000000UEE7
		A4	230	251					XPGEWT-01-0000-000000UDE7
F8	2850 K	C3	320	349	XPGEWT-01-0000-000000NF8	XPGEWT-01-0000-000000BNF8			
		C2	310	338	XPGEWT-01-0000-000000MF8	XPGEWT-01-0000-000000BMF8			
		C1	300	327	XPGEWT-01-0000-000000LF8	XPGEWT-01-0000-000000BLF8	XPGEWT-01-0000-000000HLF8		
		B5	290	316			XPGEWT-01-0000-000000HKF8		
		B4	280	305			XPGEWT-01-0000-000000HJF8		
		B3	270	294			XPGEWT-01-0000-000000HHF8		
		B2	260	284					
		B1	250	273					
		A5	240	262					
		A4	230	251					XPGEWT-01-0000-000000UDF8
		A3	220	240					XPGEWT-01-0000-000000UCF8

Notes

- Cree LED maintains a tolerance of ±7% on flux and power measurements, ±0.005 on chromaticity (CCx, CCy) measurements and a tolerance of ±2 on CRI measurements. See the Measurements section (page 49).
- XLamp XP-G4 LED order codes specify only a minimum flux bin and not a maximum. Cree LED may ship reels in flux bins higher than the minimum specified by the order code without advance notice. Shipments will always adhere to the chromaticity bin restrictions specified by the order code.
- * Flux values @ 25 °C are calculated and for reference only.

FLUX CHARACTERISTICS - STANDARD (T_j = 85 °C) - CONTINUED

Chromaticity		Minimum Luminous Flux (lm) @ 700 mA			Order Codes			
Kit	CCT	Code	Flux (lm) @ 85 °C	Flux (lm) @ 25 °C*	70 CRI Typical	70 CRI Minimum	80 CRI Minimum	90 CRI Minimum
8E	2700 K	C3	320	349		XPGEWT-01-0000-00000BN8E		
		C2	310	338		XPGEWT-01-0000-00000BM8E		
		C1	300	327		XPGEWT-01-0000-00000BL8E	XPGEWT-01-0000-00000HL8E	
		B5	290	316			XPGEWT-01-0000-00000HK8E	
		B4	280	305			XPGEWT-01-0000-00000HJ8E	
		B3	270	294			XPGEWT-01-0000-00000HH8E	
		B2	260	284				
		B1	250	273				
		A5	240	262				
		A4	230	251				
		A3	220	240				XPGEWT-01-0000-00000UC8E
8G	2700 K	A4	230	251				XPGEWT-01-0000-00000UD8G
		A3	220	240				XPGEWT-01-0000-00000UC8G

Notes

- Cree LED maintains a tolerance of ±7% on flux and power measurements, ±0.005 on chromaticity (CCx, CCy) measurements and a tolerance of ±2 on CRI measurements. See the Measurements section (page 49).
- XLamp XP-G4 LED order codes specify only a minimum flux bin and not a maximum. Cree LED may ship reels in flux bins higher than the minimum specified by the order code without advance notice. Shipments will always adhere to the chromaticity bin restrictions specified by the order code.
- * Flux values @ 25 °C are calculated and for reference only.

FLUX CHARACTERISTICS - STANDARD (T_j = 85 °C) - CONTINUED

Chromaticity		Minimum Luminous Flux (lm) @ 700 mA			Order Codes			
Kit	CCT	Code	Flux (lm) @ 85 °C	Flux (lm) @ 25 °C*	70 CRI Typical	70 CRI Minimum	80 CRI Minimum	90 CRI Minimum
E8	2700K	C3	320	349	XPGEWT-01-0000-00000NE8	XPGEWT-01-0000-00000BNE8		
		C2	310	338	XPGEWT-01-0000-00000ME8	XPGEWT-01-0000-00000BME8		
		C1	300	327	XPGEWT-01-0000-00000LE8	XPGEWT-01-0000-00000BLE8	XPGEWT-01-0000-00000HLE8	
		B5	290	316			XPGEWT-01-0000-00000HKE8	
		B4	280	305			XPGEWT-01-0000-00000HJE8	
		B3	270	294			XPGEWT-01-0000-00000HHE8	
		B2	260	284				
		B1	250	273				
		A5	240	262				
		A4	230	251				
A3	220	240						XPGEWT-01-0000-00000UCE8
EA	2200 K	B4	280	305	XPGEWT-01-0000-00000JEA	XPGEWT-01-0000-00000BJEA		
		B3	270	294	XPGEWT-01-0000-00000HEA	XPGEWT-01-0000-00000BHEA		
		B2	260	284	XPGEWT-01-0000-00000GEA	XPGEWT-01-0000-00000BGEA		
		B1	250	273	XPGEWT-01-0000-00000FEA	XPGEWT-01-0000-00000BFEA		
AE	2200 K	B4	280	305		XPGEWT-01-0000-00000BJAE		
		B3	270	294		XPGEWT-01-0000-00000BHAE		
		B2	260	284		XPGEWT-01-0000-00000BGAE		
		B1	250	273		XPGEWT-01-0000-00000BFAE		
BE	1800 K	A5	240	262	XPGEWT-01-0000-00000EBE	XPGEWT-01-0000-00000BEBE		
		A4	230	251	XPGEWT-01-0000-00000DBE	XPGEWT-01-0000-00000BDBE		
		A3	220	240	XPGEWT-01-0000-00000CBE	XPGEWT-01-0000-00000BCBE		

Notes

- Cree LED maintains a tolerance of ±7% on flux and power measurements, ±0.005 on chromaticity (CCx, CCy) measurements and a tolerance of ±2 on CRI measurements. See the Measurements section (page 49).
- XLamp XP-G4 LED order codes specify only a minimum flux bin and not a maximum. Cree LED may ship reels in flux bins higher than the minimum specified by the order code without advance notice. Shipments will always adhere to the chromaticity bin restrictions specified by the order code.
- * Flux values @ 25 °C are calculated and for reference only.

FLUX CHARACTERISTICS - HIGH INTENSITY (T_j = 85 °C)

The following table provides order codes for XLamp XP-G4 High Intensity LEDs. For a complete description of the order code nomenclature, please see the Bin and Order Code Formats section (page 47). For definitions of the chromaticity kits, please see the Cree LED’s Standard Chromaticity Kits section (page 46).

Chromaticity		Minimum Luminous Flux (lm) @ 700 mA			Order Codes			
Kit	CCT	Code	Flux (lm) @ 85 °C	Flux (lm) @ 25 °C*	70 CRI Typical	70 CRI Minimum	80 CRI Minimum	90 CRI Minimum
DT	7000 K	C2	310	338	XPGEWT-H1-0000-000000MDT	XPGEWT-H1-0000-000000BMDT		
		C1	300	327	XPGEWT-H1-0000-000000LDT	XPGEWT-H1-0000-000000BLDT		
		B5	290	316	XPGEWT-H1-0000-000000KDT	XPGEWT-H1-0000-000000BKDT	XPGEWT-H1-0000-000000HKDT	
		B4	280	305			XPGEWT-H1-0000-000000HJDT	
		B3	270	294			XPGEWT-H1-0000-000000HHDT	
E0	>6500 K	C1	300	327	XPGEWT-H1-0000-000000LE0	XPGEWT-H1-0000-000000BLE0		
		B5	290	316	XPGEWT-H1-0000-000000KE0	XPGEWT-H1-0000-000000BKE0	XPGEWT-H1-0000-000000HKE0	
		B4	280	305			XPGEWT-H1-0000-000000HJE0	
		B3	270	294			XPGEWT-H1-0000-000000HHE0	
E1	6500 K	C2	310	338	XPGEWT-H1-0000-000000ME1	XPGEWT-H1-0000-000000BME1		
		C1	300	327	XPGEWT-H1-0000-000000LE1	XPGEWT-H1-0000-000000BLE1		
		B5	290	316	XPGEWT-H1-0000-000000KE1	XPGEWT-H1-0000-000000BKE1	XPGEWT-H1-0000-000000HKE1	
		B4	280	305			XPGEWT-H1-0000-000000HJE1	
		B3	270	294			XPGEWT-H1-0000-000000HHE1	
		B2	260	284				
		B1	250	273				XPGEWT-H1-0000-000000UFE1
		A5	240	262				XPGEWT-H1-0000-000000UEE1

Notes

- Cree LED maintains a tolerance of ±7% on flux and power measurements, ±0.005 on chromaticity (CCx, CCy) measurements and a tolerance of ±2 on CRI measurements. See the Measurements section (page 49).
- XLamp XP-G4 LED order codes specify only a minimum flux bin and not a maximum. Cree LED may ship reels in flux bins higher than the minimum specified by the order code without advance notice. Shipments will always adhere to the chromaticity bin restrictions specified by the order code.
- * Flux values @ 25 °C are calculated and for reference only.

FLUX CHARACTERISTICS - HIGH INTENSITY (T_j = 85 °C) - CONTINUED

Chromaticity		Minimum Luminous Flux (lm) @ 700 mA			Order Codes			
Kit	CCT	Code	Flux (lm) @ 85 °C	Flux (lm) @ 25 °C*	70 CRI Typical	70 CRI Minimum	80 CRI Minimum	90 CRI Minimum
DV	6000 K	C2	310	338	XPGEWT-H1-0000-000000MDV	XPGEWT-H1-0000-000000BMDV		
		C1	300	327	XPGEWT-H1-0000-000000LDV	XPGEWT-H1-0000-000000BLDV		
		B5	290	316	XPGEWT-H1-0000-000000KDV	XPGEWT-H1-0000-000000BKDV	XPGEWT-H1-0000-000000HKDV	
		B4	280	305			XPGEWT-H1-0000-000000HJDV	
		B3	270	294			XPGEWT-H1-0000-000000HHDV	
50	6000 K	C2	310	338	XPGEWT-H1-0000-000000M50	XPGEWT-H1-0000-000000BM50		
		C1	300	327	XPGEWT-H1-0000-000000L50	XPGEWT-H1-0000-000000BL50		
		B5	290	316	XPGEWT-H1-0000-000000K50	XPGEWT-H1-0000-000000BK50	XPGEWT-H1-0000-000000HK50	
		B4	280	305			XPGEWT-H1-0000-000000HJ50	
		B3	270	294			XPGEWT-H1-0000-000000HH50	
E2	5700 K	C3	320	349	XPGEWT-H1-0000-000000NE2	XPGEWT-H1-0000-000000BNE2		
		C2	310	338	XPGEWT-H1-0000-000000ME2	XPGEWT-H1-0000-000000BME2		
		C1	300	327	XPGEWT-H1-0000-000000LE2	XPGEWT-H1-0000-000000BLE2		
		B5	290	316			XPGEWT-H1-0000-000000HKE2	
		B4	280	305			XPGEWT-H1-0000-000000HJE2	
		B3	270	294			XPGEWT-H1-0000-000000HHE2	
		B2	260	284				
		B1	250	273				XPGEWT-H1-0000-000000UFE2
		A5	240	262				XPGEWT-H1-0000-000000UEE2

Notes

- Cree LED maintains a tolerance of ±7% on flux and power measurements, ±0.005 on chromaticity (CCx, CCy) measurements and a tolerance of ±2 on CRI measurements. See the Measurements section (page 49).
- XLamp XP-G4 LED order codes specify only a minimum flux bin and not a maximum. Cree LED may ship reels in flux bins higher than the minimum specified by the order code without advance notice. Shipments will always adhere to the chromaticity bin restrictions specified by the order code.
- * Flux values @ 25 °C are calculated and for reference only.

FLUX CHARACTERISTICS - HIGH INTENSITY (T_j = 85 °C) - CONTINUED

Chromaticity		Minimum Luminous Flux (lm) @ 700 mA			Order Codes			
Kit	CCT	Code	Flux (lm) @ 85 °C	Flux (lm) @ 25 °C*	70 CRI Typical	70 CRI Minimum	80 CRI Minimum	90 CRI Minimum
3E	5000 K	C2	310	338	XPGEWT-H1-0000-000000M3E	XPGEWT-H1-0000-000000BM3E		
		C1	300	327	XPGEWT-H1-0000-000000L3E	XPGEWT-H1-0000-000000BL3E		
		B5	290	316	XPGEWT-H1-0000-000000K3E	XPGEWT-H1-0000-000000BK3E	XPGEWT-H1-0000-000000HK3E	
		B4	280	305			XPGEWT-H1-0000-000000HJ3E	
		B3	270	294			XPGEWT-H1-0000-000000HH3E	
		B2	260	284				
		B1	250	273				XPGEWT-H1-0000-000000UF3E
		A5	240	262				XPGEWT-H1-0000-000000UE3E
E3	5000 K	C2	310	338	XPGEWT-H1-0000-000000ME3	XPGEWT-H1-0000-000000BME3		
		C1	300	327	XPGEWT-H1-0000-000000LE3	XPGEWT-H1-0000-000000BLE3		
		B5	290	316	XPGEWT-H1-0000-000000KE3	XPGEWT-H1-0000-000000BKE3	XPGEWT-H1-0000-000000HKE3	
		B4	280	305			XPGEWT-H1-0000-000000HJE3	
		B3	270	294			XPGEWT-H1-0000-000000HHE3	
		B2	260	284				
		B1	250	273				XPGEWT-H1-0000-000000UFE3
		A5	240	262				XPGEWT-H1-0000-000000UEE3

Notes

- Cree LED maintains a tolerance of ±7% on flux and power measurements, ±0.005 on chromaticity (CCx, CCy) measurements and a tolerance of ±2 on CRI measurements. See the Measurements section (page 49).
- XLamp XP-G4 LED order codes specify only a minimum flux bin and not a maximum. Cree LED may ship reels in flux bins higher than the minimum specified by the order code without advance notice. Shipments will always adhere to the chromaticity bin restrictions specified by the order code.
- * Flux values @ 25 °C are calculated and for reference only.

FLUX CHARACTERISTICS - HIGH INTENSITY (T_j = 85 °C) - CONTINUED

Chromaticity		Minimum Luminous Flux (lm) @ 700 mA			Order Codes			
Kit	CCT	Code	Flux (lm) @ 85 °C	Flux (lm) @ 25 °C*	70 CRI Typical	70 CRI Minimum	80 CRI Minimum	90 CRI Minimum
F4	4750 K	C2	310	338	XPGEWT-H1-0000-000000MF4	XPGEWT-H1-0000-000000BMF4		
		C1	300	327	XPGEWT-H1-0000-000000LF4	XPGEWT-H1-0000-000000BLF4		
		B5	290	316	XPGEWT-H1-0000-000000KF4	XPGEWT-H1-0000-000000BKF4		
		B4	280	305			XPGEWT-H1-0000-000000HJF4	
		B3	270	294			XPGEWT-H1-0000-000000HHF4	
		B2	260	284			XPGEWT-H1-0000-000000HGF4	
		B1	250	273				
		A5	240	262				XPGEWT-H1-0000-000000UEF4
		A4	230	251				XPGEWT-H1-0000-000000UDF4
4E	4500K	C2	310	338	XPGEWT-H1-0000-000000M4E	XPGEWT-H1-0000-000000BM4E		
		C1	300	327	XPGEWT-H1-0000-000000L4E	XPGEWT-H1-0000-000000BL4E		
		B5	290	316	XPGEWT-H1-0000-000000K4E	XPGEWT-H1-0000-000000BK4E		
		B4	280	305			XPGEWT-H1-0000-000000HJ4E	
		B3	270	294			XPGEWT-H1-0000-000000HH4E	
		B2	260	284			XPGEWT-H1-0000-000000HG4E	
		B1	250	273				
		A5	240	262				XPGEWT-H1-0000-000000UE4E
		A4	230	251				XPGEWT-H1-0000-000000UD4E

Notes

- Cree LED maintains a tolerance of ±7% on flux and power measurements, ±0.005 on chromaticity (CCx, CCy) measurements and a tolerance of ±2 on CRI measurements. See the Measurements section (page 49).
- XLamp XP-G4 LED order codes specify only a minimum flux bin and not a maximum. Cree LED may ship reels in flux bins higher than the minimum specified by the order code without advance notice. Shipments will always adhere to the chromaticity bin restrictions specified by the order code.
- * Flux values @ 25 °C are calculated and for reference only.

FLUX CHARACTERISTICS - HIGH INTENSITY (T_J = 85 °C) - CONTINUED

Chromaticity		Minimum Luminous Flux (lm) @ 700 mA			Order Codes			
Kit	CCT	Code	Flux (lm) @ 85 °C	Flux (lm) @ 25 °C*	70 CRI Typical	70 CRI Minimum	80 CRI Minimum	90 CRI Minimum
E4	4500 K	C2	310	338	XPGEWT-H1-0000-000000ME4	XPGEWT-H1-0000-000000BME4		
		C1	300	327	XPGEWT-H1-0000-000000LE4	XPGEWT-H1-0000-000000BLE4		
		B5	290	316	XPGEWT-H1-0000-000000KE4	XPGEWT-H1-0000-000000BKE4		
		B4	280	305			XPGEWT-H1-0000-000000HJE4	
		B3	270	294			XPGEWT-H1-0000-000000HHE4	
		B2	260	284			XPGEWT-H1-0000-000000HGE4	
		B1	250	273				
		A5	240	262				XPGEWT-H1-0000-000000UEE4
		A4	230	251				XPGEWT-H1-0000-000000UDE4
F5	4200 K	C2	310	338	XPGEWT-H1-0000-000000MF5	XPGEWT-H1-0000-000000BMF5		
		C1	300	327	XPGEWT-H1-0000-000000LF5	XPGEWT-H1-0000-000000BLF5		
		B5	290	316	XPGEWT-H1-0000-000000KF5	XPGEWT-H1-0000-000000BKF5		
		B4	280	305			XPGEWT-H1-0000-000000HJF5	
		B3	270	294			XPGEWT-H1-0000-000000HHF5	
		B2	260	284			XPGEWT-H1-0000-000000HGF5	
		B1	250	273				
		A5	240	262				XPGEWT-H1-0000-000000UEF5
		A4	230	251				XPGEWT-H1-0000-000000UDF5

Notes

- Cree LED maintains a tolerance of ±7% on flux and power measurements, ±0.005 on chromaticity (CCx, CCy) measurements and a tolerance of ±2 on CRI measurements. See the Measurements section (page 49).
- XLamp XP-G4 LED order codes specify only a minimum flux bin and not a maximum. Cree LED may ship reels in flux bins higher than the minimum specified by the order code without advance notice. Shipments will always adhere to the chromaticity bin restrictions specified by the order code.
- * Flux values @ 25 °C are calculated and for reference only.

FLUX CHARACTERISTICS - HIGH INTENSITY (T_j = 85 °C) - CONTINUED

Chromaticity		Minimum Luminous Flux (lm) @ 700 mA			Order Codes			
Kit	CCT	Code	Flux (lm) @ 85 °C	Flux (lm) @ 25 °C*	70 CRI Typical	70 CRI Minimum	80 CRI Minimum	90 CRI Minimum
5E	4000 K	C2	310	338	XPGEWT-H1-0000-000000M5E	XPGEWT-H1-0000-000000BM5E		
		C1	300	327	XPGEWT-H1-0000-000000L5E	XPGEWT-H1-0000-000000BL5E		
		B5	290	316	XPGEWT-H1-0000-000000K5E	XPGEWT-H1-0000-000000BK5E		
		B4	280	305			XPGEWT-H1-0000-000000HJ5E	
		B3	270	294			XPGEWT-H1-0000-000000HH5E	
		B2	260	284			XPGEWT-H1-0000-000000HG5E	
		B1	250	273				
		A5	240	262				XPGEWT-H1-0000-000000UE5E
		A4	230	251				XPGEWT-H1-0000-000000UD5E
5G	4000 K	A5	240	262				XPGEWT-H1-0000-000000UE5G
		A4	230	251				XPGEWT-H1-0000-000000UD5G
E5	4000 K	C2	310	338	XPGEWT-H1-0000-000000ME5	XPGEWT-H1-0000-000000BME5		
		C1	300	327	XPGEWT-H1-0000-000000LE5	XPGEWT-H1-0000-000000BLE5		
		B5	290	316	XPGEWT-H1-0000-000000KE5	XPGEWT-H1-0000-000000BKE5		
		B4	280	305			XPGEWT-H1-0000-000000HJE5	
		B3	270	294			XPGEWT-H1-0000-000000HHE5	
		B2	260	284			XPGEWT-H1-0000-000000HGE5	
		B1	250	273				
		A5	240	262				XPGEWT-H1-0000-000000UEE5
		A4	230	251				XPGEWT-H1-0000-000000UDE5

Notes

- Cree LED maintains a tolerance of ±7% on flux and power measurements, ±0.005 on chromaticity (CCx, CCy) measurements and a tolerance of ±2 on CRI measurements. See the Measurements section (page 49).
- XLamp XP-G4 LED order codes specify only a minimum flux bin and not a maximum. Cree LED may ship reels in flux bins higher than the minimum specified by the order code without advance notice. Shipments will always adhere to the chromaticity bin restrictions specified by the order code.
- * Flux values @ 25 °C are calculated and for reference only.

FLUX CHARACTERISTICS - HIGH INTENSITY (T_j = 85 °C) - CONTINUED

Chromaticity		Minimum Luminous Flux (lm) @ 700 mA			Order Codes				
Kit	CCT	Code	Flux (lm) @ 85 °C	Flux (lm) @ 25 °C*	70 CRI Typical	70 CRI Minimum	80 CRI Minimum	90 CRI Minimum	
F6	3700 K	C2	310	338	XPGEWT-H1-0000-000000MF6	XPGEWT-H1-0000-000000BMF6			
		C1	300	327	XPGEWT-H1-0000-000000LF6	XPGEWT-H1-0000-000000BLF6			
		B5	290	316	XPGEWT-H1-0000-000000KF6	XPGEWT-H1-0000-000000BKF6			
		B4	280	305					
		B3	270	294			XPGEWT-H1-0000-000000HHF6		
		B2	260	284			XPGEWT-H1-0000-000000HGF6		
		B1	250	273					
		A5	240	262					
		A4	230	251					XPGEWT-H1-0000-000000UDF6
		A3	220	240					XPGEWT-H1-0000-000000UCF6
6E	3500 K	C2	310	338	XPGEWT-H1-0000-000000M6E	XPGEWT-H1-0000-000000BM6E			
		C1	300	327	XPGEWT-H1-0000-000000L6E	XPGEWT-H1-0000-000000BL6E			
		B5	290	316	XPGEWT-H1-0000-000000K6E	XPGEWT-H1-0000-000000BK6E			
		B4	280	305					
		B3	270	294			XPGEWT-H1-0000-000000HH6E		
		B2	260	284			XPGEWT-H1-0000-000000HG6E		
		B1	250	273					
		A5	240	262					
		A4	230	251					XPGEWT-H1-0000-000000UD6E
		A3	220	240					XPGEWT-H1-0000-000000UC6E
6G	3500 K	A4	230	251				XPGEWT-H1-0000-000000UD6G	
		A3	220	240				XPGEWT-H1-0000-000000UC6G	

Notes

- Cree LED maintains a tolerance of ±7% on flux and power measurements, ±0.005 on chromaticity (CCx, CCy) measurements and a tolerance of ±2 on CRI measurements. See the Measurements section (page 49).
- XLamp XP-G4 LED order codes specify only a minimum flux bin and not a maximum. Cree LED may ship reels in flux bins higher than the minimum specified by the order code without advance notice. Shipments will always adhere to the chromaticity bin restrictions specified by the order code.
- * Flux values @ 25 °C are calculated and for reference only.

FLUX CHARACTERISTICS - HIGH INTENSITY (T_j = 85 °C) - CONTINUED

Chromaticity		Minimum Luminous Flux (lm) @ 700 mA			Order Codes				
Kit	CCT	Code	Flux (lm) @ 85 °C	Flux (lm) @ 25 °C*	70 CRI Typical	70 CRI Minimum	80 CRI Minimum	90 CRI Minimum	
E6	3500 K	C2	310	338	XPGEWT-H1-0000-000000ME6	XPGEWT-H1-0000-000000BME6			
		C1	300	327	XPGEWT-H1-0000-000000LE6	XPGEWT-H1-0000-000000BLE6			
		B5	290	316	XPGEWT-H1-0000-000000KE6	XPGEWT-H1-0000-000000BKE6			
		B4	280	305					
		B3	270	294			XPGEWT-H1-0000-000000HHE6		
		B2	260	284			XPGEWT-H1-0000-000000HGE6		
		B1	250	273					
		A5	240	262					
		A4	230	251					XPGEWT-H1-0000-000000UDE6
		A3	220	240					XPGEWT-H1-0000-000000UCE6
F7	3200K	C1	300	327	XPGEWT-H1-0000-000000LF7	XPGEWT-H1-0000-000000BLF7			
		B5	290	316	XPGEWT-H1-0000-000000KF7	XPGEWT-H1-0000-000000BKF7			
		B4	280	305	XPGEWT-H1-0000-000000JF7	XPGEWT-H1-0000-000000BJF7			
		B3	270	294					
		B2	260	284			XPGEWT-H1-0000-000000HGF7		
		B1	250	273			XPGEWT-H1-0000-000000HFF7		
		A5	240	262			XPGEWT-H1-0000-000000HEF7		
		A4	230	251					
		A3	220	240					
		A2	210	229					XPGEWT-H1-0000-000000UBF7
		A1	200	218					XPGEWT-H1-0000-000000UAF7

Notes

- Cree LED maintains a tolerance of ±7% on flux and power measurements, ±0.005 on chromaticity (CCx, CCy) measurements and a tolerance of ±2 on CRI measurements. See the Measurements section (page 49).
- XLamp XP-G4 LED order codes specify only a minimum flux bin and not a maximum. Cree LED may ship reels in flux bins higher than the minimum specified by the order code without advance notice. Shipments will always adhere to the chromaticity bin restrictions specified by the order code.
- * Flux values @ 25 °C are calculated and for reference only.

FLUX CHARACTERISTICS - HIGH INTENSITY (T_J = 85 °C) - CONTINUED

Chromaticity		Minimum Luminous Flux (lm) @ 700 mA			Order Codes			
Kit	CCT	Code	Flux (lm) @ 85 °C	Flux (lm) @ 25 °C*	70 CRI Typical	70 CRI Minimum	80 CRI Minimum	90 CRI Minimum
7E	3000 K	C1	300	327	XPGEWT-H1-0000-000000L7E	XPGEWT-H1-0000-000000BL7E		
		B5	290	316	XPGEWT-H1-0000-000000K7E	XPGEWT-H1-0000-000000BK7E		
		B4	280	305	XPGEWT-H1-0000-000000J7E	XPGEWT-H1-0000-000000BJ7E		
		B3	270	294				
		B2	260	284			XPGEWT-H1-0000-000000HG7E	
		B1	250	273			XPGEWT-H1-0000-000000HF7E	
		A5	240	262			XPGEWT-H1-0000-000000HE7E	
		A4	230	251				
		A3	220	240				
		A2	210	229				
		A1	200	218				XPGEWT-H1-0000-000000UA7E
7G	3000 K	A2	210	229				XPGEWT-H1-0000-000000UB7G
		A1	200	218				XPGEWT-H1-0000-000000UA7G

Notes

- Cree LED maintains a tolerance of ±7% on flux and power measurements, ±0.005 on chromaticity (CCx, CCy) measurements and a tolerance of ±2 on CRI measurements. See the Measurements section (page 49).
- XLamp XP-G4 LED order codes specify only a minimum flux bin and not a maximum. Cree LED may ship reels in flux bins higher than the minimum specified by the order code without advance notice. Shipments will always adhere to the chromaticity bin restrictions specified by the order code.
- * Flux values @ 25 °C are calculated and for reference only.

FLUX CHARACTERISTICS - HIGH INTENSITY (T_J = 85 °C) - CONTINUED

Chromaticity		Minimum Luminous Flux (lm) @ 700 mA			Order Codes			
Kit	CCT	Code	Flux (lm) @ 85 °C	Flux (lm) @ 25 °C*	70 CRI Typical	70 CRI Minimum	80 CRI Minimum	90 CRI Minimum
E7	3000 K	C1	300	327	XPGEWT-H1-0000-00000LE7	XPGEWT-H1-0000-00000BLE7		
		B5	290	316	XPGEWT-H1-0000-00000KE7	XPGEWT-H1-0000-00000BKE7		
		B4	280	305	XPGEWT-H1-0000-00000JE7	XPGEWT-H1-0000-00000BJE7		
		B3	270	294				
		B2	260	284			XPGEWT-H1-0000-00000HGE7	
		B1	250	273			XPGEWT-H1-0000-00000HFE7	
		A5	240	262			XPGEWT-H1-0000-00000HEE7	
		A4	230	251				
		A3	220	240				
		A2	210	229				XPGEWT-H1-0000-00000UBE7
		A1	200	218				XPGEWT-H1-0000-00000UAE7
F8	2850 K	C1	300	327	XPGEWT-H1-0000-00000LF8	XPGEWT-H1-0000-00000BLF8		
		B5	290	316	XPGEWT-H1-0000-00000KF8	XPGEWT-H1-0000-00000BKF8		
		B4	280	305	XPGEWT-H1-0000-00000JF8	XPGEWT-H1-0000-00000BJF8		
		B3	270	294				
		B2	260	284			XPGEWT-H1-0000-00000HGF8	
		B1	250	273			XPGEWT-H1-0000-00000HFF8	
		A5	240	262			XPGEWT-H1-0000-00000HEF8	
		A4	230	251				
		A3	220	240				
		A2	210	229				XPGEWT-H1-0000-00000UBF8
		A1	200	218				XPGEWT-H1-0000-00000UAF8

Notes

- Cree LED maintains a tolerance of ±7% on flux and power measurements, ±0.005 on chromaticity (CCx, CCy) measurements and a tolerance of ±2 on CRI measurements. See the Measurements section (page 49).
- XLamp XP-G4 LED order codes specify only a minimum flux bin and not a maximum. Cree LED may ship reels in flux bins higher than the minimum specified by the order code without advance notice. Shipments will always adhere to the chromaticity bin restrictions specified by the order code.
- * Flux values @ 25 °C are calculated and for reference only.

FLUX CHARACTERISTICS - HIGH INTENSITY (T_J = 85 °C) - CONTINUED

Chromaticity		Minimum Luminous Flux (lm) @ 700 mA			Order Codes			
Kit	CCT	Code	Flux (lm) @ 85 °C	Flux (lm) @ 25 °C*	70 CRI Typical	70 CRI Minimum	80 CRI Minimum	90 CRI Minimum
8E	2700 K	C1	300	327	XPGEWT-H1-0000-00000L8E	XPGEWT-H1-0000-00000BL8E		
		B5	290	316	XPGEWT-H1-0000-00000K8E	XPGEWT-H1-0000-00000BK8E		
		B4	280	305	XPGEWT-H1-0000-00000J8E	XPGEWT-H1-0000-00000BJ8E		
		B3	270	294				
		B2	260	284			XPGEWT-H1-0000-00000HG8E	
		B1	250	273			XPGEWT-H1-0000-00000HF8E	
		A5	240	262			XPGEWT-H1-0000-00000HE8E	
		A4	230	251				
		A3	220	240				
		A2	210	229				XPGEWT-H1-0000-00000UB8E
		A1	200	218				XPGEWT-H1-0000-00000UA8E
8G	2700 K	A2	210	229				XPGEWT-H1-0000-00000UB8G
		A1	200	218				XPGEWT-H1-0000-00000UA8G

Notes

- Cree LED maintains a tolerance of ±7% on flux and power measurements, ±0.005 on chromaticity (CCx, CCy) measurements and a tolerance of ±2 on CRI measurements. See the Measurements section (page 49).
- XLamp XP-G4 LED order codes specify only a minimum flux bin and not a maximum. Cree LED may ship reels in flux bins higher than the minimum specified by the order code without advance notice. Shipments will always adhere to the chromaticity bin restrictions specified by the order code.
- * Flux values @ 25 °C are calculated and for reference only.

FLUX CHARACTERISTICS - HIGH INTENSITY (T_J = 85 °C) - CONTINUED

Chromaticity		Minimum Luminous Flux (lm) @ 700 mA			Order Codes			
Kit	CCT	Code	Flux (lm) @ 85 °C	Flux (lm) @ 25 °C*	70 CRI Typical	70 CRI Minimum	80 CRI Minimum	90 CRI Minimum
E8	2700K	Ce81	300	327	XPGEWT-H1-0000-000000LE8	XPGEWT-H1-0000-00000BLE8		
		B5	290	316	XPGEWT-H1-0000-000000KE8	XPGEWT-H1-0000-00000BKE8		
		B4	280	305	XPGEWT-H1-0000-000000JE8	XPGEWT-H1-0000-00000BJE8		
		B3	270	294				
		B2	260	284			XPGEWT-H1-0000-00000HGE8	
		B1	250	273			XPGEWT-H1-0000-00000HFE8	
		A5	240	262			XPGEWT-H1-0000-00000HEE8	
		A4	230	251				
		A3	220	240				
		A2	210	229				
A1	200	218						XPGEWT-H1-0000-00000UAE8

Notes

- Cree LED maintains a tolerance of ±7% on flux and power measurements, ±0.005 on chromaticity (CCx, CCy) measurements and a tolerance of ±2 on CRI measurements. See the Measurements section (page 49).
- XLamp XP-G4 LED order codes specify only a minimum flux bin and not a maximum. Cree LED may ship reels in flux bins higher than the minimum specified by the order code without advance notice. Shipments will always adhere to the chromaticity bin restrictions specified by the order code.
- * Flux values @ 25 °C are calculated and for reference only.

FLUX CHARACTERISTICS - BROADCAST ORDER CODES AND BINS ($T_j = 85\text{ }^\circ\text{C}$)

The following table provides order codes for XLamp XP-G4 Broadcast LEDs. For a complete description of the order code nomenclature, please see the Bin and Order Code Formats section (page 47). For definitions of the chromaticity kits, please see the Standard Chromaticity Kits section (page 46).

Chromaticity		Minimum Luminous Flux (lm) @ 700 mA			Order Codes	
Kit	CCT	Flux Bin	Flux (lm) @ 85 °C	Flux (lm) @ 25 °C*	90 CRI Minimum 90 TLCI Minimum	95 CRI Minimum 95 TLCI Minimum
E2	5700 K	B4	280	305	XPGEWT-01-0000-0T000UJE2	
		B3	270	294	XPGEWT-01-0000-0T000UHE2	XPGEWT-01-0000-0T000ZHE2
		B2	260	284	XPGEWT-01-0000-0T000UGE2	XPGEWT-01-0000-0T000ZGE2
		B1	250	273		XPGEWT-01-0000-0T000ZFE2

Notes

- TLCI refers to the [European Broadcast Union's Television Lighting Consistency Index 2012](#), which aids broadcasters in assessing the colorimetric quality of lighting in their production environment. Cree LED maintains a tolerance of ± 2 on TLCI measurements. See the Measurements section (page 49).
- Cree LED maintains a tolerance of $\pm 7\%$ on flux and power measurements, ± 0.005 on chromaticity (CCx, CCy) measurements and a tolerance of ± 2 on CRI. See the Measurements section (page 49).
- XLamp XP-G4 LED order codes specify only a minimum flux bin and not a maximum. Cree LED may ship reels in flux bins higher than the minimum specified by the order code without advance notice. Shipments will always adhere to the chromaticity bin restrictions specified by the order code.
- * Flux values @ 25 °C are calculated and for reference only.

RELATIVE SPECTRAL POWER DISTRIBUTION

XP-G4 Standard

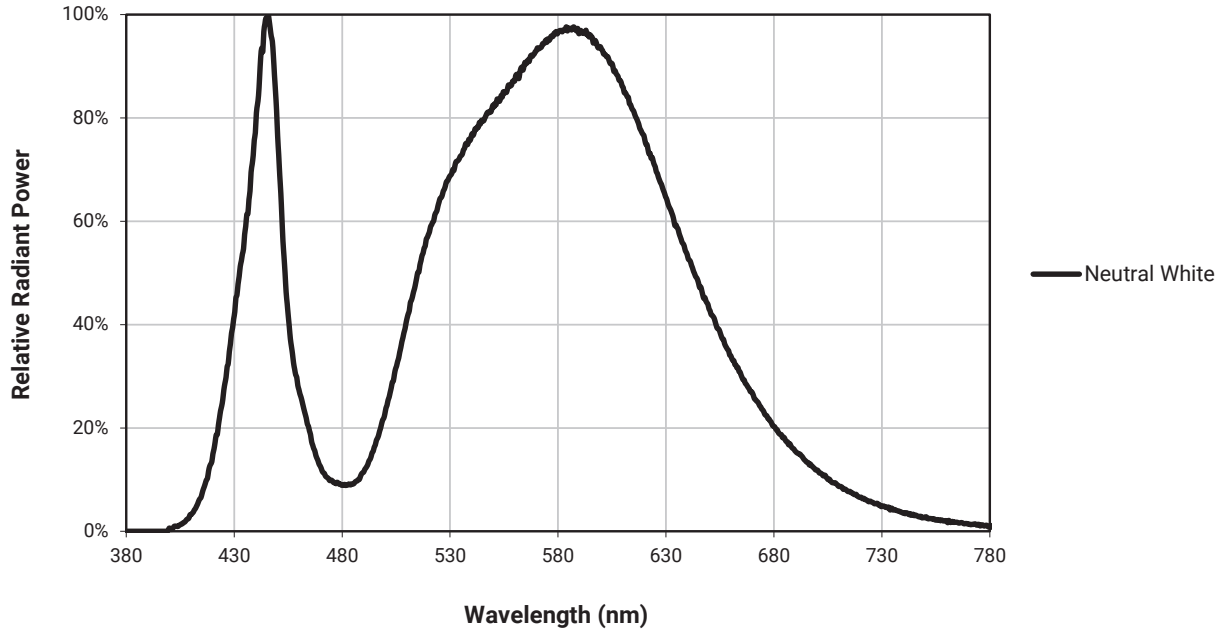

XP-G4 High Intensity

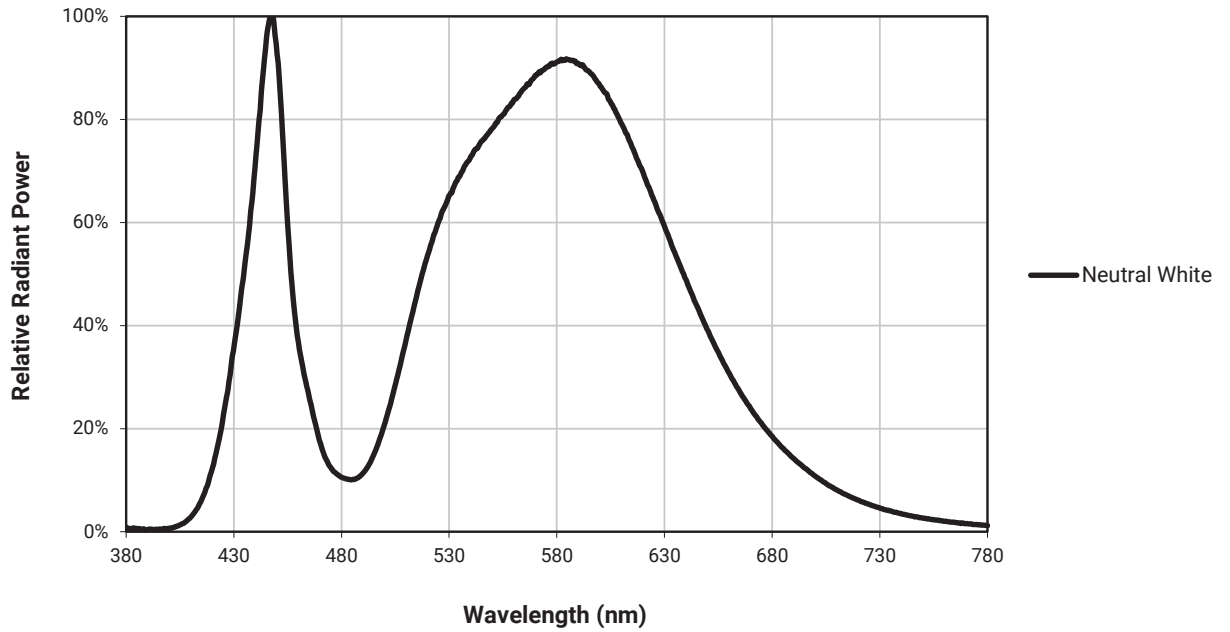

RELATIVE FLUX VS. JUNCTION TEMPERATURE ($I_f = 700 \text{ mA}$)

XP-G4 Standard

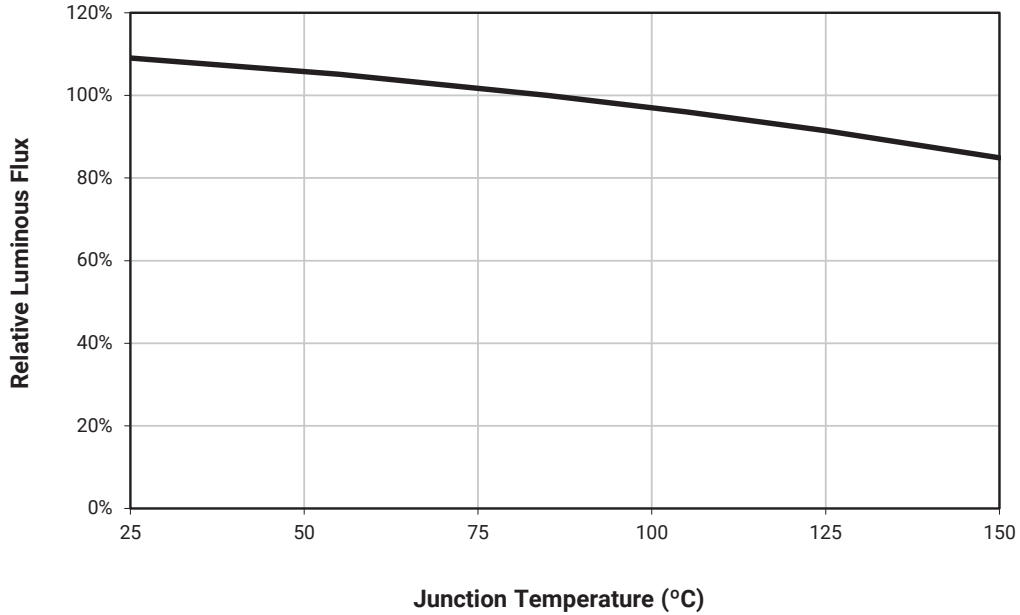

XP-G4 High Intensity

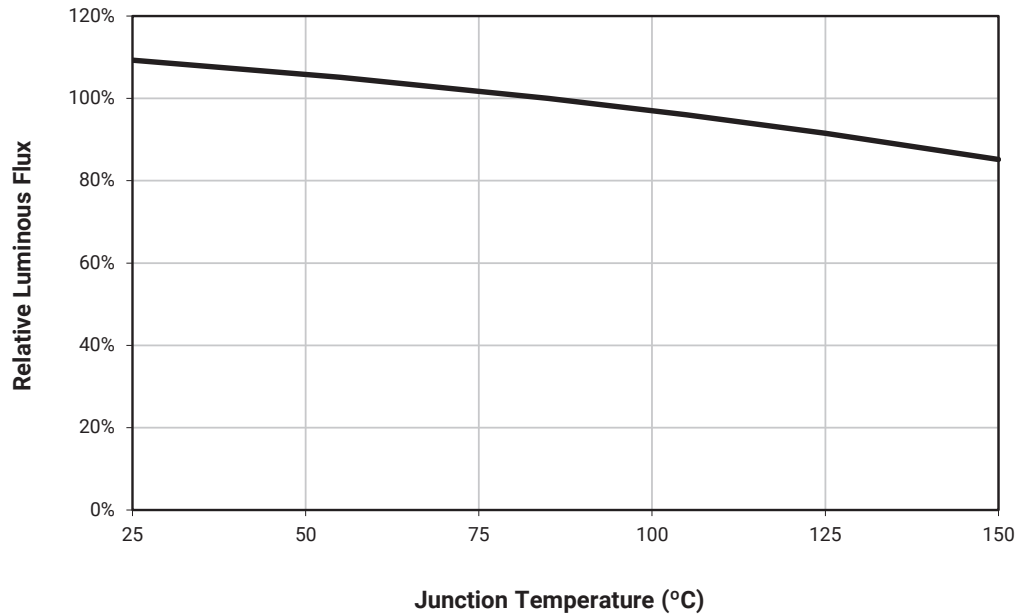

ELECTRICAL CHARACTERISTICS ($T_j = 85^\circ\text{C}$)

XP-G4 Standard

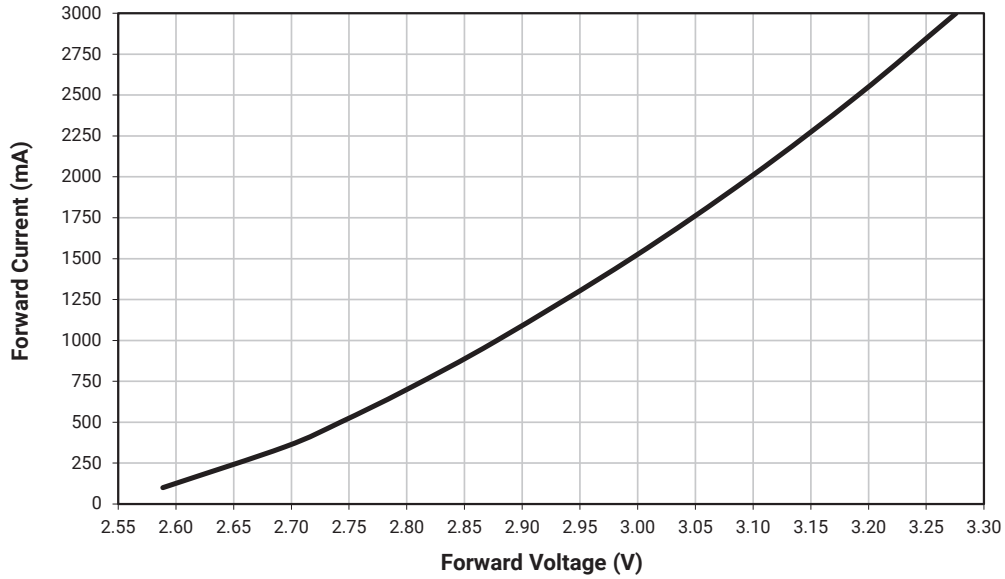

XP-G4 High Intensity

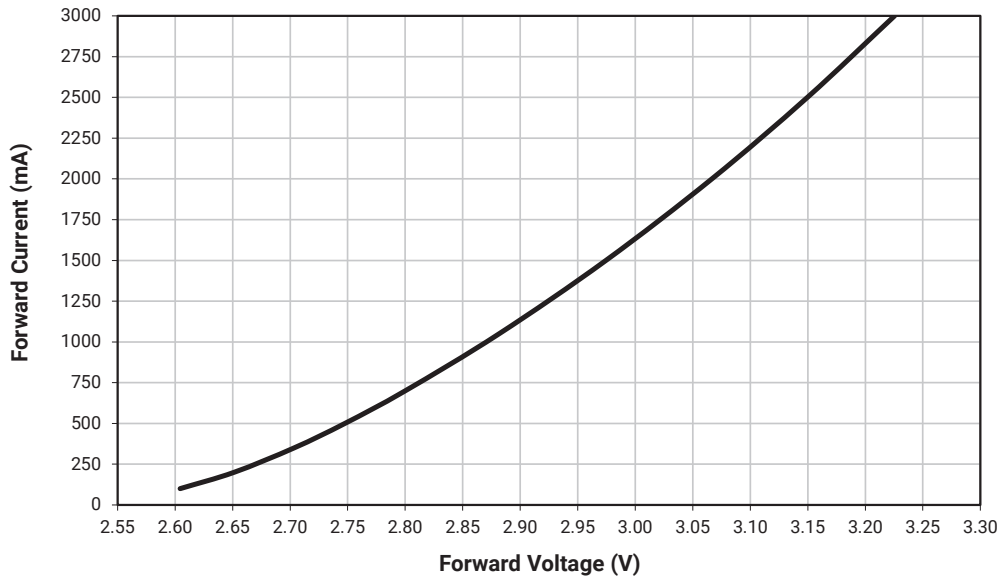

RELATIVE LUMINOUS FLUX VS. CURRENT ($T_j = 85\text{ }^\circ\text{C}$)

XP-G4 Standard

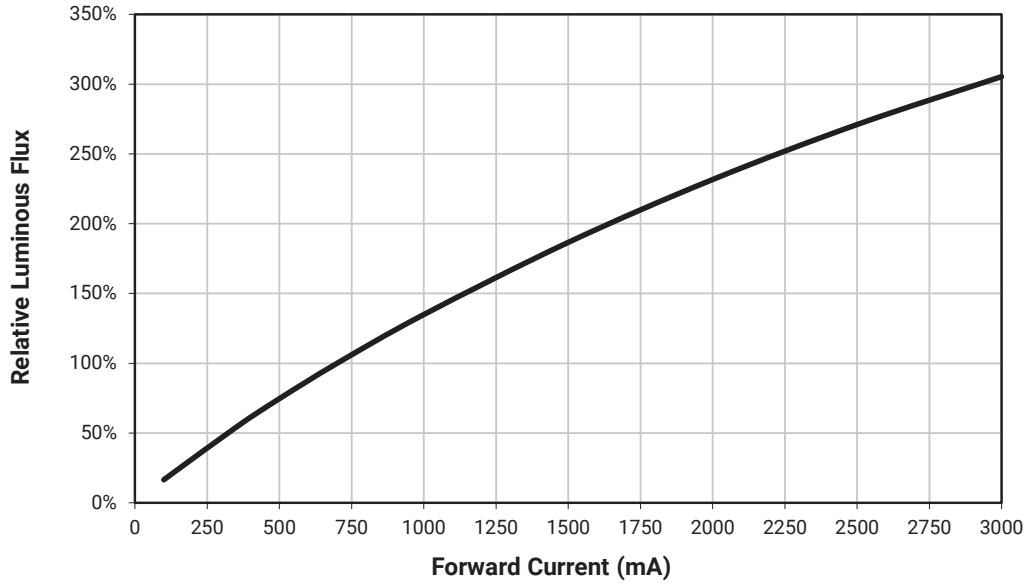

XP-G4 High Intensity

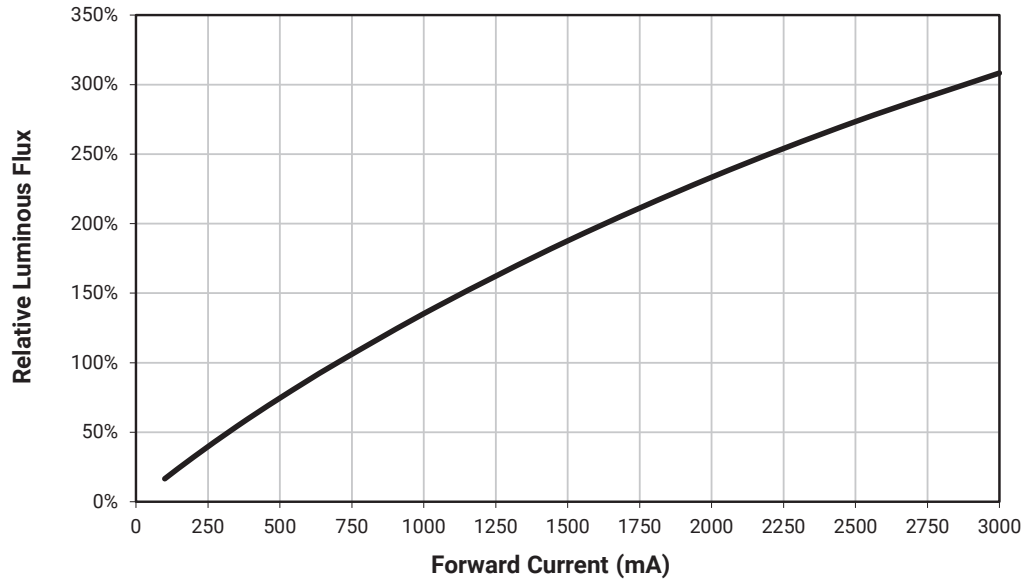

RELATIVE CHROMATICITY VS. CURRENT AND TEMPERATURE

Data shown is representative of typical XP-G4 70 CRI performance.

XP-G4 Standard

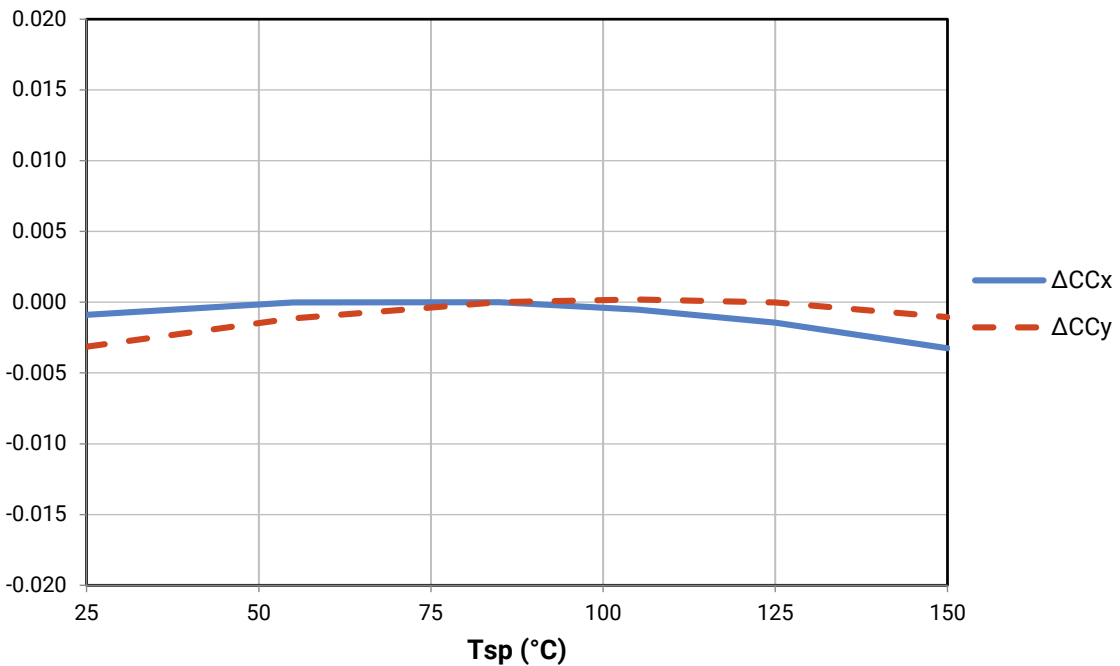
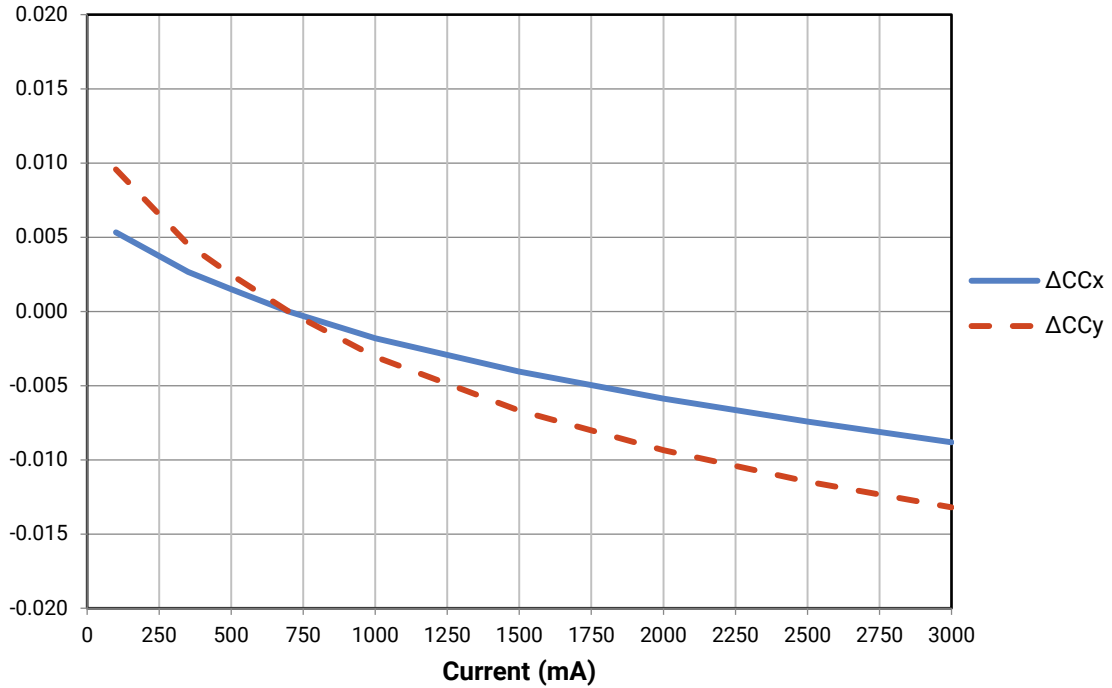

RELATIVE CHROMATICITY VS. CURRENT AND TEMPERATURE - CONTINUED

XP-G4 High Intensity

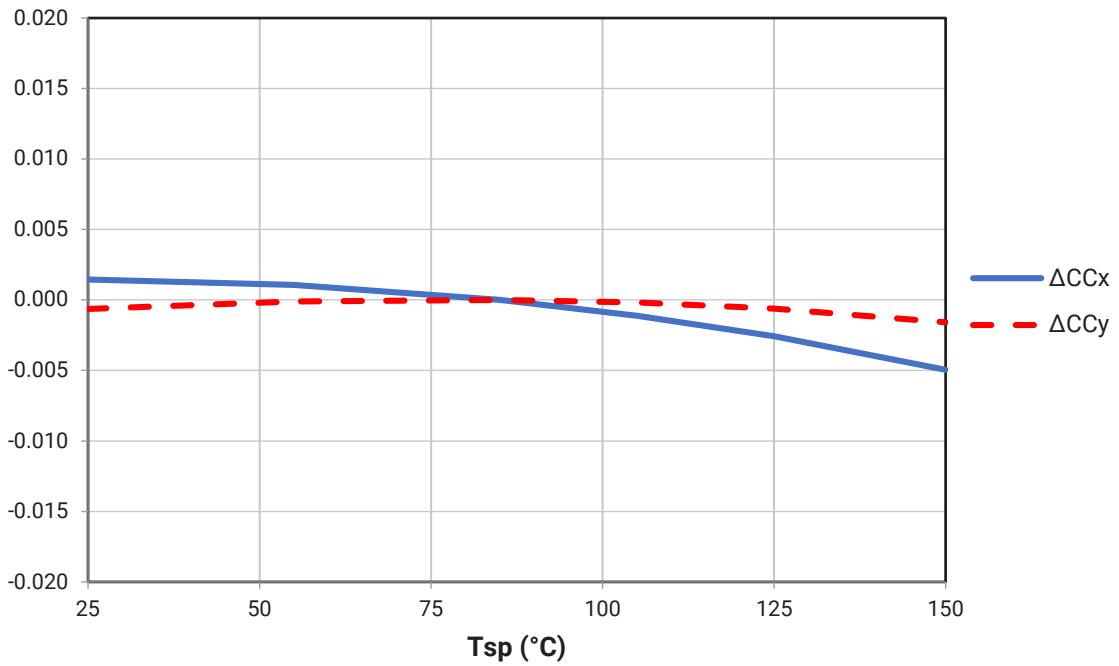
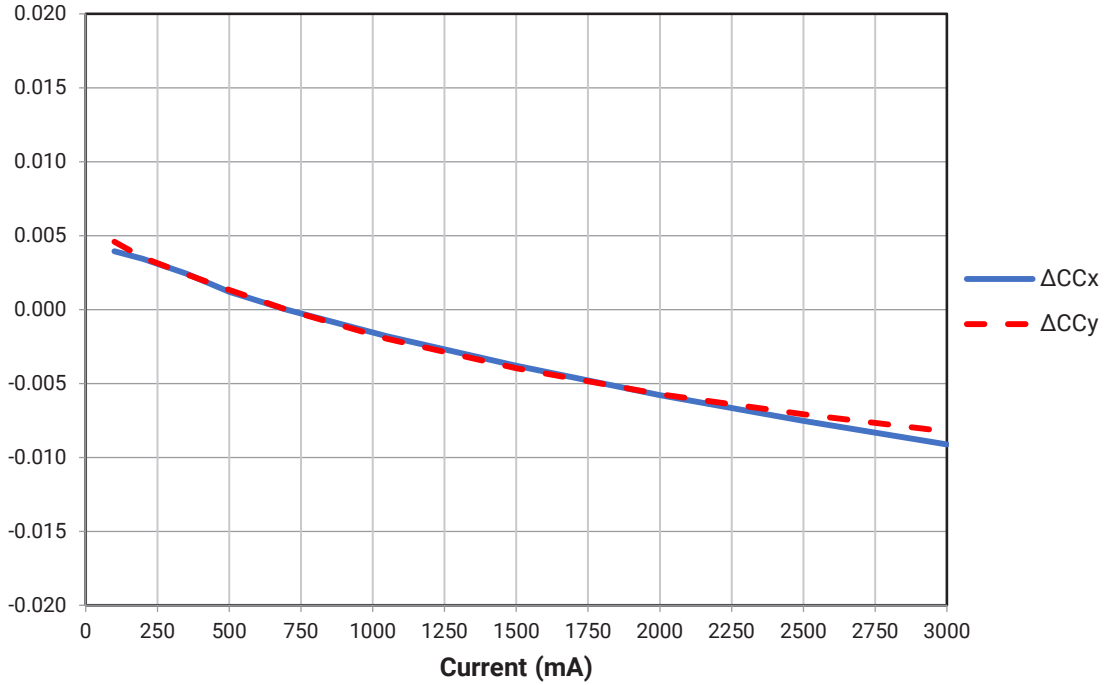

TYPICAL SPATIAL DISTRIBUTION

XP-G4 Standard

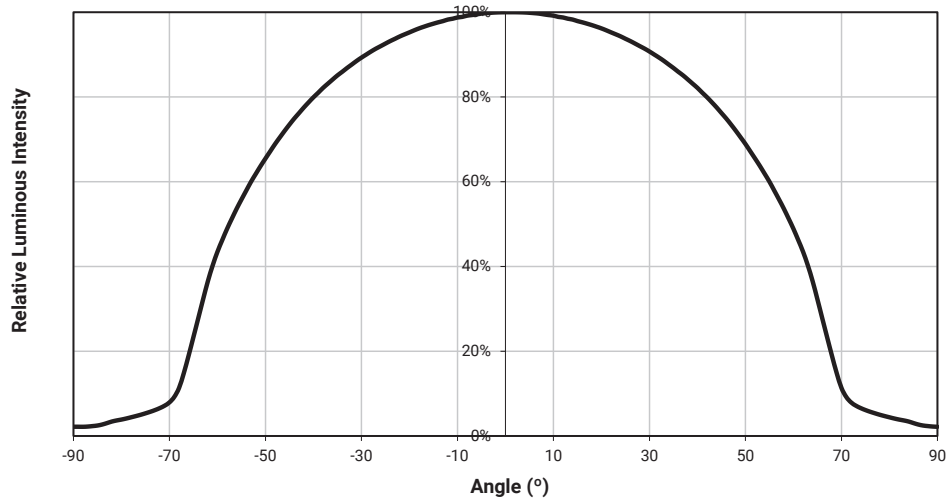

XP-G4 High Intensity

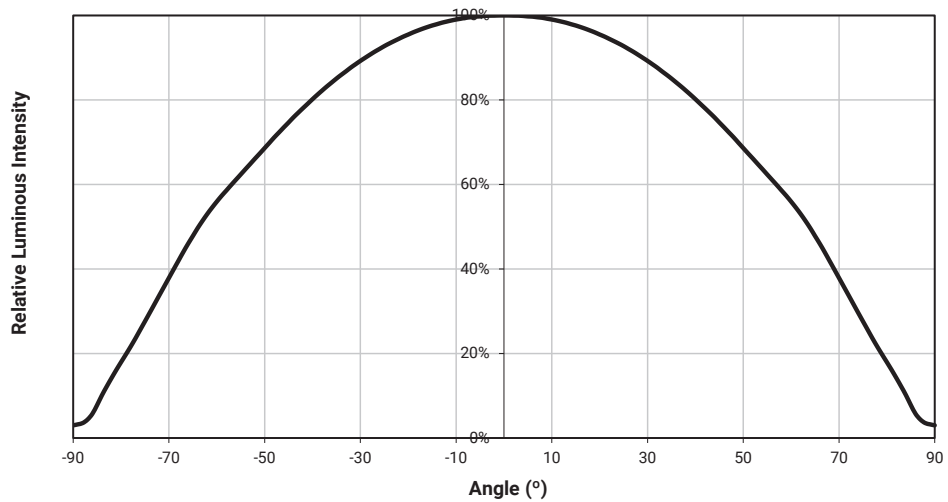

THERMAL DESIGN

The maximum forward current is determined by the thermal resistance between the LED junction and ambient. It is crucial for the end product to be designed in a manner that minimizes the thermal resistance from the solder point to ambient in order to optimize lamp life and optical characteristics.

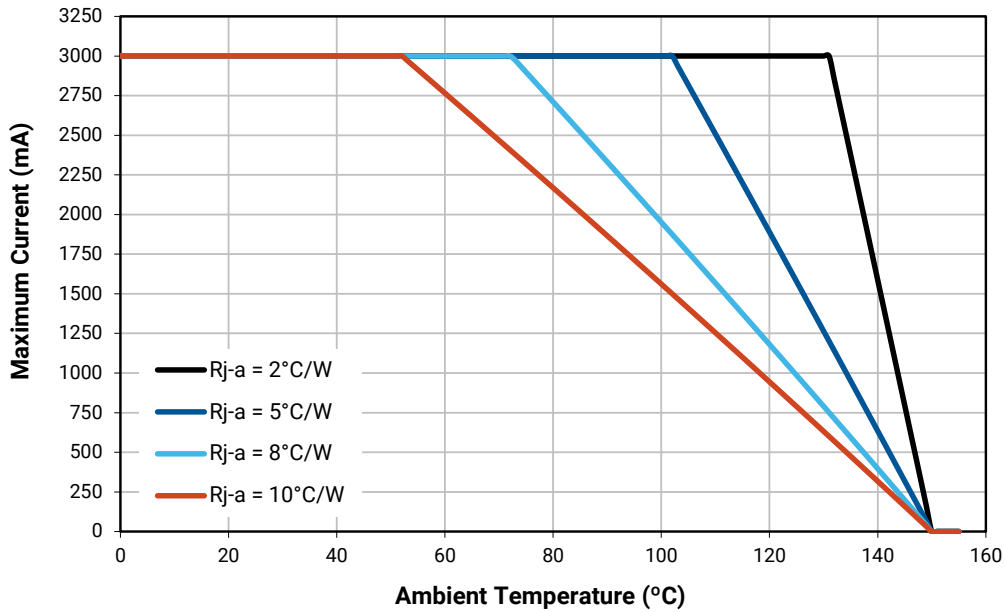

PERFORMANCE GROUPS - LUMINOUS FLUX

XLamp XP-G4 LEDs are tested for luminous flux and placed into one of the following luminous-flux groups.

Group Code	Minimum Luminous Flux (lm) @ 700 mA	Maximum Luminous Flux (lm) @ 700 mA
A1	200	210
A2	210	220
A3	220	230
A4	230	240
A5	240	250
B1	250	260
B2	260	270
B3	270	280
B4	280	290
B5	290	300
C1	300	310
C2	310	320
C3	320	330
C4	330	340
C5	340	350
D1	350	360
D2	360	370
D3	370	380

PERFORMANCE GROUPS - CHROMATICITY

Region	x	y	Region	x	y	Region	x	y	Region	x	y
0A	0.2950	0.2970	0B	0.2920	0.3060	0C	0.2984	0.3133	0D	0.2984	0.3133
	0.2920	0.3060		0.2895	0.3135		0.2962	0.3220		0.3048	0.3207
	0.2984	0.3133		0.2962	0.3220		0.3028	0.3304		0.3068	0.3113
	0.3009	0.3042		0.2984	0.3133		0.3048	0.3207		0.3009	0.3042
0R	0.2980	0.2880	0S	0.2895	0.3135	0T	0.2962	0.3220	0U	0.3037	0.2937
	0.2950	0.2970		0.2870	0.3210		0.2937	0.3312		0.3009	0.3042
	0.3009	0.3042		0.2937	0.3312		0.3005	0.3415		0.3068	0.3113
	0.3037	0.2937		0.2962	0.3220		0.3028	0.3304		0.3093	0.2993
1A	0.3048	0.3207	1B	0.3028	0.3304	1C	0.3115	0.3391	1D	0.3130	0.3290
	0.3130	0.3290		0.3115	0.3391		0.3205	0.3481		0.3213	0.3373
	0.3144	0.3186		0.3130	0.3290		0.3213	0.3373		0.3221	0.3261
	0.3068	0.3113		0.3048	0.3207		0.3130	0.3290		0.3144	0.3186
1R	0.3068	0.3113	1S	0.3005	0.3415	1T	0.3099	0.3509	1U	0.3144	0.3186
	0.3144	0.3186		0.3099	0.3509		0.3196	0.3602		0.3221	0.3261
	0.3161	0.3059		0.3115	0.3391		0.3205	0.3481		0.3231	0.3120
	0.3093	0.2993		0.3028	0.3304		0.3115	0.3391		0.3161	0.3059
2A	0.3215	0.3350	2B	0.3207	0.3462	2C	0.3290	0.3538	2D	0.3290	0.3417
	0.3290	0.3417		0.3290	0.3538		0.3376	0.3616		0.3371	0.3490
	0.3290	0.3300		0.3290	0.3417		0.3371	0.3490		0.3366	0.3369
	0.3222	0.3243		0.3215	0.3350		0.3290	0.3417		0.3290	0.3300
2R	0.3222	0.3243	2S	0.3196	0.3602	2T	0.3290	0.3690	2U	0.3290	0.3300
	0.3290	0.3300		0.3290	0.3690		0.3381	0.3762		0.3366	0.3369
	0.3290	0.3180		0.3290	0.3538		0.3376	0.3616		0.3361	0.3245
	0.3231	0.3120		0.3207	0.3462		0.3290	0.3538		0.3290	0.3180
3A	0.3371	0.3490	3B	0.3376	0.3616	3C	0.3463	0.3687	3D	0.3451	0.3554
	0.3451	0.3554		0.3463	0.3687		0.3551	0.3760		0.3533	0.3620
	0.3440	0.3427		0.3451	0.3554		0.3533	0.3620		0.3515	0.3487
	0.3366	0.3369		0.3371	0.3490		0.3451	0.3554		0.3440	0.3427
4A	0.3530	0.3597	4B	0.3548	0.3736	4C	0.3641	0.3804	4D	0.3615	0.3659
	0.3615	0.3659		0.3641	0.3804		0.3736	0.3874		0.3702	0.3722
	0.3590	0.3521		0.3615	0.3659		0.3702	0.3722		0.3670	0.3578
	0.3512	0.3465		0.3530	0.3597		0.3615	0.3659		0.3590	0.3521
5A1	0.3670	0.3578	5A2	0.3686	0.3649	5A3	0.3744	0.3685	5A4	0.3726	0.3612
	0.3686	0.3649		0.3702	0.3722		0.3763	0.3760		0.3744	0.3685
	0.3744	0.3685		0.3763	0.3760		0.3825	0.3798		0.3804	0.3721
	0.3726	0.3612		0.3744	0.3685		0.3804	0.3721		0.3783	0.3646

PERFORMANCE GROUPS - CHROMATICITY (CONTINUED)

Region	x	y	Region	x	y	Region	x	y	Region	x	y
5B1	0.3702	0.3722	5B2	0.3719	0.3797	5B3	0.3782	0.3837	5B4	0.3763	0.3760
	0.3719	0.3797		0.3736	0.3874		0.3802	0.3916		0.3782	0.3837
	0.3782	0.3837		0.3802	0.3916		0.3869	0.3958		0.3847	0.3877
	0.3763	0.3760		0.3782	0.3837		0.3847	0.3877		0.3825	0.3798
5C1	0.3825	0.3798	5C2	0.3847	0.3877	5C3	0.3912	0.3917	5C4	0.3887	0.3836
	0.3847	0.3877		0.3869	0.3958		0.3937	0.4001		0.3912	0.3917
	0.3912	0.3917		0.3937	0.4001		0.4006	0.4044		0.3978	0.3958
	0.3887	0.3836		0.3912	0.3917		0.3978	0.3958		0.3950	0.3875
5D1	0.3783	0.3646	5D2	0.3804	0.3721	5D3	0.3863	0.3758	5D4	0.3840	0.3681
	0.3804	0.3721		0.3825	0.3798		0.3887	0.3836		0.3863	0.3758
	0.3863	0.3758		0.3887	0.3836		0.3950	0.3875		0.3924	0.3794
	0.3840	0.3681		0.3863	0.3758		0.3924	0.3794		0.3898	0.3716
6A1	0.3889	0.3690	6A2	0.3915	0.3768	6A3	0.3981	0.3800	6A4	0.3953	0.3720
	0.3915	0.3768		0.3941	0.3848		0.4010	0.3882		0.3981	0.3800
	0.3981	0.3800		0.4010	0.3882		0.4080	0.3916		0.4048	0.3832
	0.3953	0.3720		0.3981	0.3800		0.4048	0.3832		0.4017	0.3751
6B1	0.3941	0.3848	6B2	0.3968	0.3930	6B3	0.4040	0.3966	6B4	0.4010	0.3882
	0.3968	0.3930		0.3996	0.4015		0.4071	0.4052		0.4040	0.3966
	0.4040	0.3966		0.4071	0.4052		0.4146	0.4089		0.4113	0.4001
	0.4010	0.3882		0.4040	0.3966		0.4113	0.4001		0.4080	0.3916
6C1	0.4080	0.3916	6C2	0.4113	0.4001	6C3	0.4186	0.4037	6C4	0.4150	0.3950
	0.4113	0.4001		0.4146	0.4089		0.4222	0.4127		0.4186	0.4037
	0.4186	0.4037		0.4222	0.4127		0.4299	0.4165		0.4259	0.4073
	0.4150	0.3950		0.4186	0.4037		0.4259	0.4073		0.4221	0.3984
6D1	0.4017	0.3751	6D2	0.4048	0.3832	6D3	0.4116	0.3865	6D4	0.4082	0.3782
	0.4048	0.3832		0.4080	0.3916		0.4150	0.3950		0.4116	0.3865
	0.4116	0.3865		0.4150	0.3950		0.4221	0.3984		0.4183	0.3898
	0.4082	0.3782		0.4116	0.3865		0.4183	0.3898		0.4147	0.3814
7A1	0.4147	0.3814	7A2	0.4183	0.3898	7A3	0.4242	0.3919	7A4	0.4203	0.3833
	0.4183	0.3898		0.4221	0.3984		0.4281	0.4006		0.4242	0.3919
	0.4242	0.3919		0.4281	0.4006		0.4342	0.4028		0.4300	0.3939
	0.4203	0.3833		0.4242	0.3919		0.4300	0.3939		0.4259	0.3853
7B1	0.4221	0.3984	7B2	0.4259	0.4073	7B3	0.4322	0.4096	7B4	0.4281	0.4006
	0.4259	0.4073		0.4299	0.4165		0.4364	0.4188		0.4322	0.4096
	0.4322	0.4096		0.4364	0.4188		0.4430	0.4212		0.4385	0.4119
	0.4281	0.4006		0.4322	0.4096		0.4385	0.4119		0.4342	0.4028

PERFORMANCE GROUPS - CHROMATICITY (CONTINUED)

Region	x	y	Region	x	y	Region	x	y	Region	x	y
7C1	0.4342	0.4028	7C2	0.4385	0.4119	7C3	0.4449	0.4141	7C4	0.4403	0.4049
	0.4385	0.4119		0.4430	0.4212		0.4496	0.4236		0.4449	0.4141
	0.4449	0.4141		0.4496	0.4236		0.4562	0.4260		0.4513	0.4164
	0.4403	0.4049		0.4449	0.4141		0.4513	0.4164		0.4465	0.4071
7D1	0.4259	0.3853	7D2	0.4300	0.3939	7D3	0.4359	0.3960	7D4	0.4316	0.3873
	0.4300	0.3939		0.4342	0.4028		0.4403	0.4049		0.4359	0.3960
	0.4359	0.3960		0.4403	0.4049		0.4465	0.4071		0.4418	0.3981
	0.4316	0.3873		0.4359	0.3960		0.4418	0.3981		0.4373	0.3893
8A1	0.4373	0.3893	8A2	0.4418	0.3981	8A3	0.4475	0.3994	8A4	0.4428	0.3906
	0.4418	0.3981		0.4465	0.4071		0.4523	0.4085		0.4475	0.3994
	0.4475	0.3994		0.4523	0.4085		0.4582	0.4099		0.4532	0.4008
	0.4428	0.3906		0.4475	0.3994		0.4532	0.4008		0.4483	0.3919
8B1	0.4465	0.4071	8B2	0.4513	0.4164	8B3	0.4573	0.4178	8B4	0.4523	0.4085
	0.4513	0.4164		0.4562	0.4260		0.4624	0.4274		0.4573	0.4178
	0.4573	0.4178		0.4624	0.4274		0.4687	0.4289		0.4634	0.4193
	0.4523	0.4085		0.4573	0.4178		0.4634	0.4193		0.4582	0.4099
8C1	0.4582	0.4099	8C2	0.4634	0.4193	8C3	0.4695	0.4207	8C4	0.4641	0.4112
	0.4634	0.4193		0.4687	0.4289		0.4750	0.4304		0.4695	0.4207
	0.4695	0.4207		0.4750	0.4304		0.4813	0.4319		0.4756	0.4221
	0.4641	0.4112		0.4695	0.4207		0.4756	0.4221		0.4700	0.4126
8D1	0.4483	0.3919	8D2	0.4532	0.4008	8D3	0.4589	0.4021	8D4	0.4538	0.3931
	0.4532	0.4008		0.4582	0.4099		0.4641	0.4112		0.4589	0.4021
	0.4589	0.4021		0.4641	0.4112		0.4700	0.4126		0.4646	0.4034
	0.4538	0.3931		0.4589	0.4021		0.4646	0.4034		0.4593	0.3944
AA1	0.4822	0.3973	AA2	0.4884	0.4067	AA3	0.4942	0.4066	AA4	0.4879	0.3972
	0.4884	0.4067		0.4946	0.4162		0.5006	0.4160		0.4942	0.4066
	0.4942	0.4066		0.5006	0.4160		0.5066	0.4158		0.5001	0.4064
	0.4879	0.3972		0.4942	0.4066		0.5001	0.4064		0.4936	0.3970
AB1	0.4946	0.4162	AB2	0.5008	0.4256	AB3	0.5069	0.4254	AB4	0.5006	0.4160
	0.5008	0.4256		0.5070	0.4350		0.5133	0.4348		0.5069	0.4254
	0.5069	0.4254		0.5133	0.4348		0.5196	0.4346		0.5131	0.4252
	0.5006	0.4160		0.5069	0.4254		0.5131	0.4252		0.5066	0.4158
AC1	0.5066	0.4158	AC2	0.5131	0.4252	AC3	0.5192	0.4250	AC4	0.5126	0.4156
	0.5131	0.4252		0.5196	0.4346		0.5258	0.4343		0.5192	0.4250
	0.5192	0.4250		0.5258	0.4343		0.5321	0.4341		0.5253	0.4248
	0.5126	0.4156		0.5192	0.4250		0.5253	0.4248		0.5186	0.4154

PERFORMANCE GROUPS - CHROMATICITY (CONTINUED)

Region	x	y	Region	x	y	Region	x	y	Region	x	y
AD1	0.4936	0.3970	AD2	0.5001	0.4064	AD3	0.5059	0.4062	AD4	0.4993	0.3969
	0.5001	0.4064		0.5066	0.4158		0.5126	0.4156		0.5059	0.4062
	0.5059	0.4062		0.5126	0.4156		0.5186	0.4154		0.5118	0.4061
	0.4993	0.3969		0.5059	0.4062		0.5118	0.4061		0.5050	0.3967

XLamp XP-G4 LEDs are tested for chromaticity and placed into one of the regions defined by the following bounding coordinates.

EasyWhite Color Temperatures – 3-Step Ellipse						
Bin Code	CCT	Center Point		Major Axis	Minor Axis	Rotation Angle (°)
		x	y	a	b	
6G	3500 K	0.4073	0.3917	0.00927	0.00414	54.0
7G	3000 K	0.4338	0.4030	0.00834	0.00408	53.2
8G	2700 K	0.4577	0.4099	0.00834	0.00420	48.5

EasyWhite Color Temperatures – 5-Step Ellipse						
Bin Code	CCT	Center Point		Major Axis	Minor Axis	Rotation Angle (°)
		x	y	a	b	
2E	5700 K	0.3287	0.3417	0.01230	0.00600	72.0
3E	5000 K	0.3447	0.3553	0.01400	0.00520	65.0
4E	4500 K	0.3611	0.3658	0.01420	0.00550	61.5
5E	4000 K	0.3818	0.3797	0.01565	0.00670	53.7
6E	3500 K	0.4073	0.3917	0.01545	0.00690	54.0
7E	3000 K	0.4338	0.4030	0.01390	0.00680	53.2
8E	2700 K	0.4577	0.4099	0.01350	0.00700	48.5
AE	2200 K	0.5066	0.4158	0.01633	0.00800	45.5
BE	1800 K	0.5492	0.4082	0.00683	0.01546	40.0

CREE LED'S STANDARD COOL WHITE KITS PLOTTED ON ANSI STANDARD CHROMATICITY REGIONS

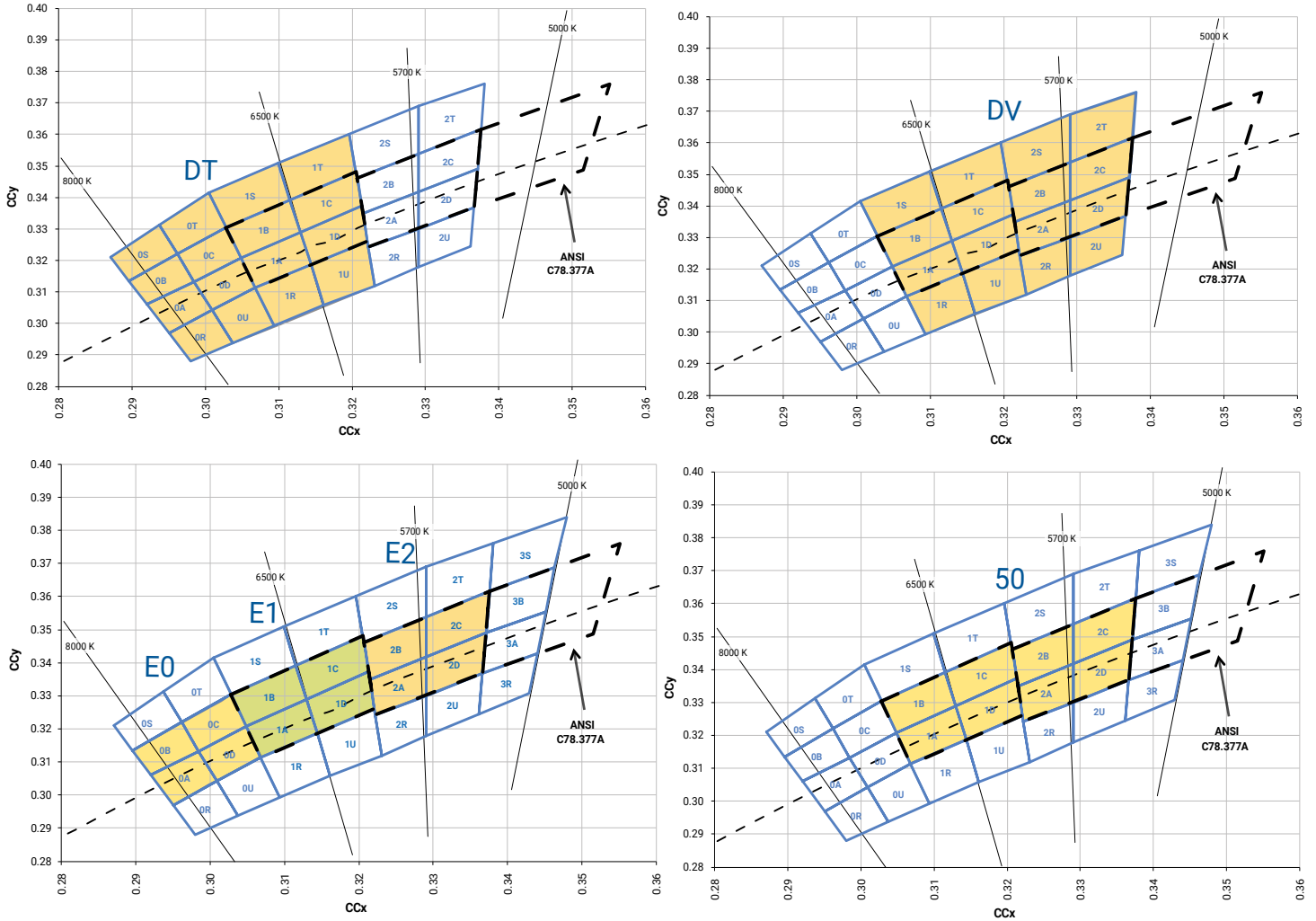

CREE LED'S STANDARD WARM AND NEUTRAL WHITE KITS PLOTTED ON ANSI STANDARD CHROMATICITY REGIONS

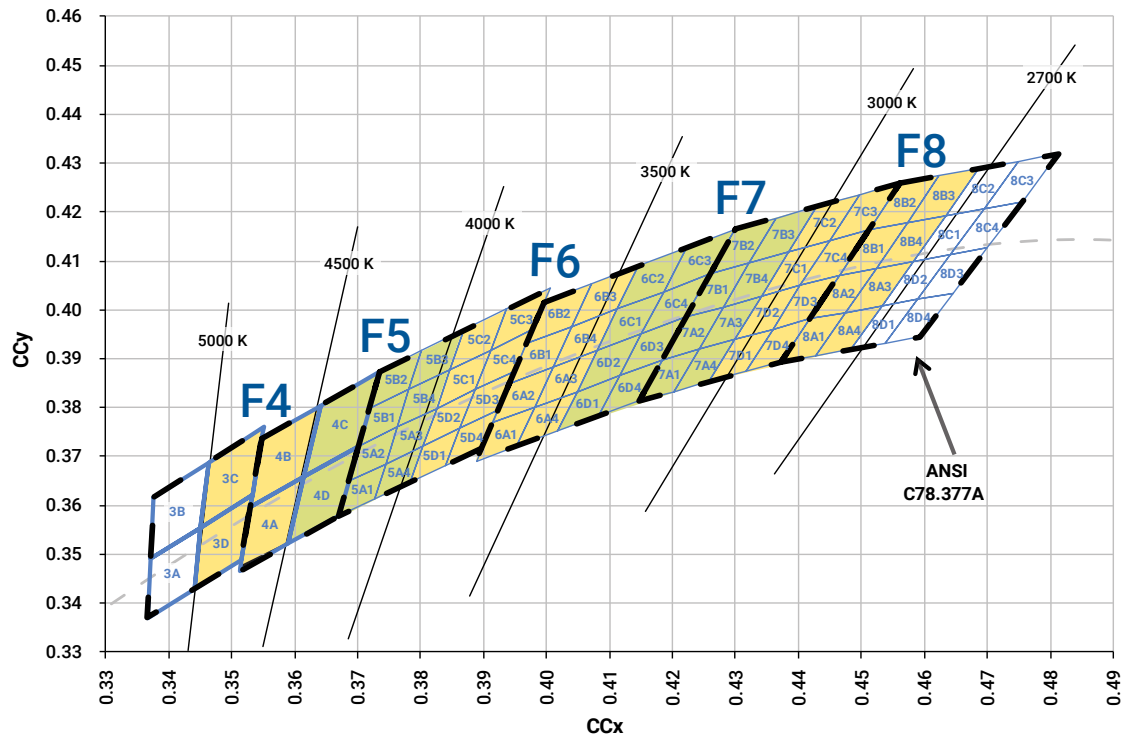
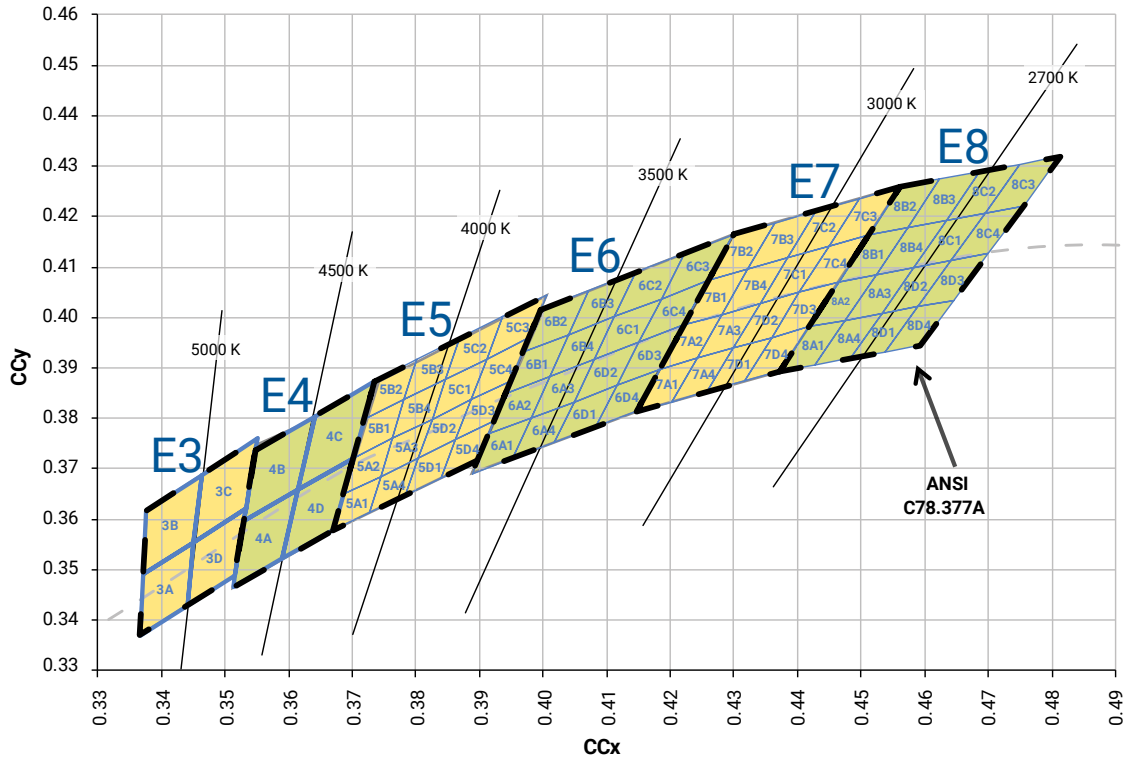

CREE LED'S STANDARD WARM AND NEUTRAL WHITE KITS PLOTTED ON ANSI STANDARD CHROMATICITY REGIONS - CONTINUED

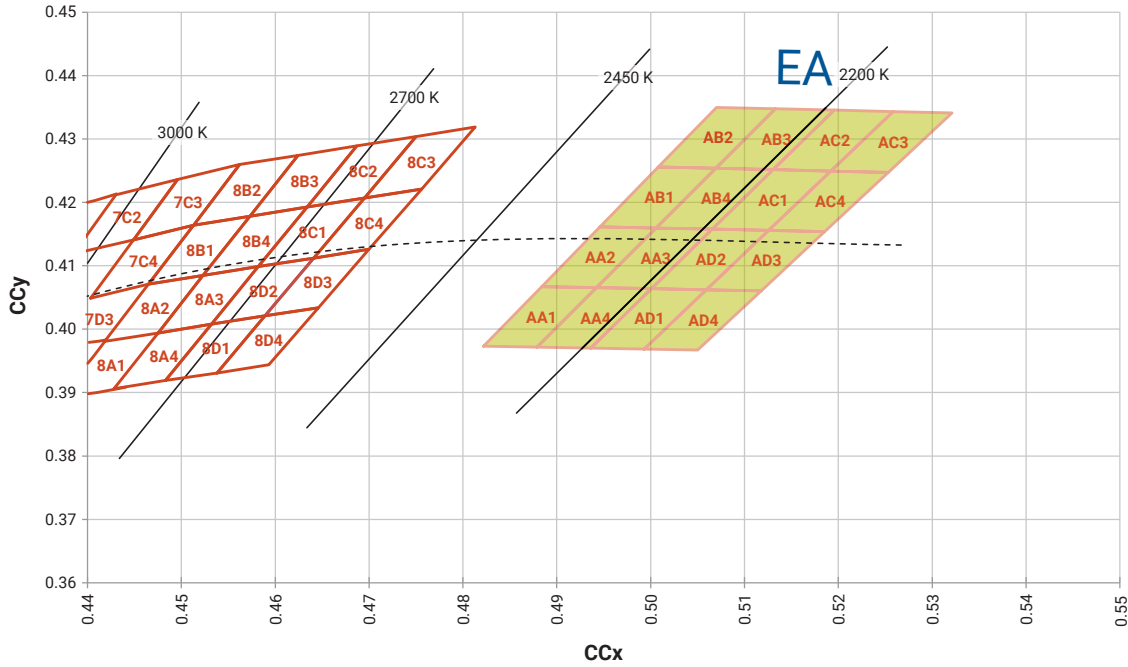

CREE LED'S EASYWHITE® WHITE KITS PLOTTED ON ANSI STANDARD CHROMATICITY REGIONS

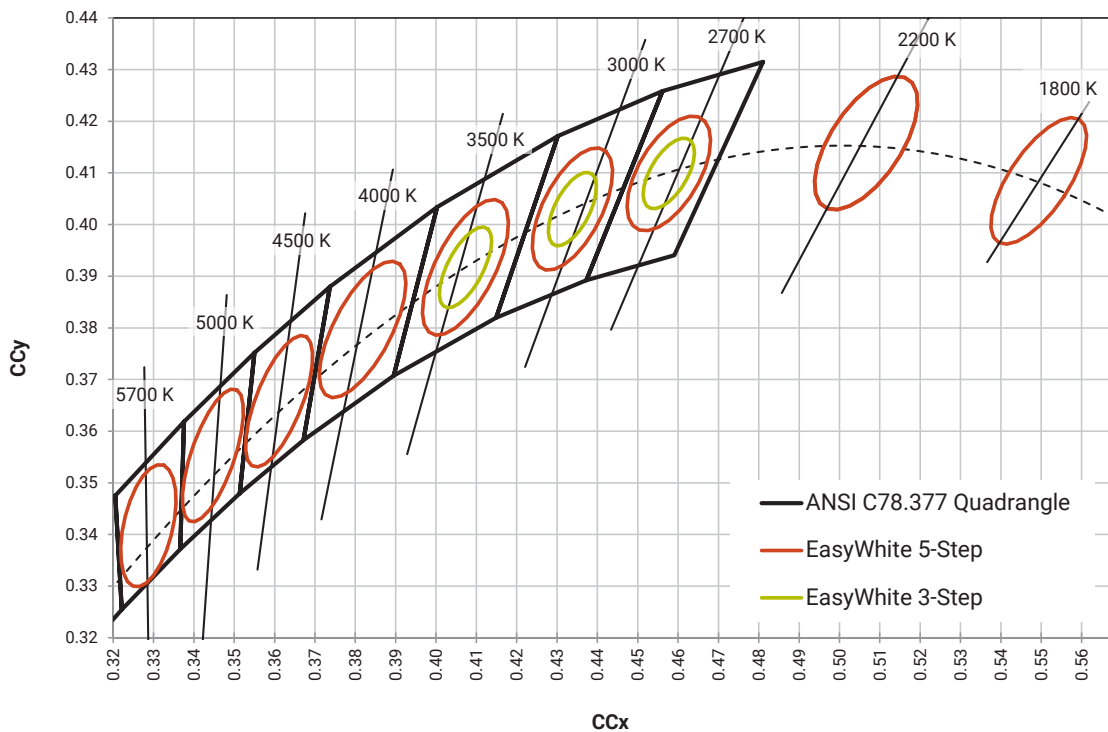

CREE LED'S STANDARD CHROMATICITY KITS

The following table provides the chromaticity bins associated with chromaticity kits.

Color	CCT	Kit	Chromaticity Bins
Cool White	7000 K	DT	0A, 0B, 0C, 0D, 0R, 0S, 0T, 0U, 1A, 1B, 1C, 1D, 1R, 1S, 1T, 1U
	>6500 K	E0	0A, 0B, 0C, 0D
	6500 K	E1	1A, 1B, 1C, 1D
	6000 K	DV	1A, 1B, 1C, 1D, 1R, 1S, 1T, 1U, 2A, 2B, 2C, 2D, 2R, 2S, 2T, 2U
	6200 K	50	1A, 1B, 1C, 1D, 2A, 2B, 2C, 2D
	5700 K	E2	2A, 2B, 2C, 2D
	5700 K	2E	57E
Neutral White	5000 K	3E	50E
	5000 K	E3	3A, 3B, 3C, 3D
	4750 K	F4	3C, 3D, 4A, 4B
	4500 K	4E	45E
	4500 K	E4	4A, 4B, 4C, 4D
	4250 K	F5	4C, 4D, 5A1, 5A2, 5A3, 5A4, 5B1, 5B2, 5B3, 5B4
	4000 K	5E	40E
	4000 K	E5	5A1, 5A2, 5A3, 5A4, 5B1, 5B2, 5B3, 5B4, 5C1, 5C2, 5C3, 5C4, 5D1, 5D2, 5D3, 5D4
Warm White	3750 K	F6	5C1, 5C2, 5C3, 5C4, 5D1, 5D2, 5D3, 5D4, 6A1, 6A2, 6A3, 6A4, 6B1, 6B2, 6B3, 6B4
	3500 K	6E	35E, 35G
	3500 K	6G	35G
	3500 K	E6	6A1, 6A2, 6A3, 6A4, 6B1, 6B2, 6B3, 6B4, 6C1, 6C2, 6C3, 6C4, 6D1, 6D2, 6D3, 6D4
	3250 K	F7	6C1, 6C2, 6C3, 6C4, 6D1, 6D2, 6D3, 6D4, 7A1, 7A2, 7A3, 7A4, 7B1, 7B2, 7B3, 7B4
	3000 K	7E	30E, 30G
	3000 K	7G	30G
	3000 K	E7	7A1, 7A2, 7A3, 7A4, 7B1, 7B2, 7B3, 7B4, 7C1, 7C2, 7C3, 7C4, 7D1, 7D2, 7D3, 7D4
	2850 K	F8	7C1, 7C2, 7C3, 7C4, 7D1, 7D2, 7D3, 7D4, 8A1, 8A2, 8A3, 8A4, 8B1, 8B2, 8B3, 8B4
	2700 K	8E	27E, 27G
	2700 K	8G	27G
	2700 K	E8	8A1, 8A2, 8A3, 8A4, 8B1, 8B2, 8B3, 8B4, 8C1, 8C2, 8C3, 8C4, 8D1, 8D2, 8D3, 8D4
	2200 K	EA	AA1, AA2, AA3, AA4, AB1, AB2, AB3, AB4, AC1, AC2, AC3, AC4, AD1, AD2, AD3, AD4
	2200 K	AE	22E
	1800 K	BE	18E

BIN AND ORDER CODE FORMATS

XP-G4 bin codes and order codes are configured in the following manner:

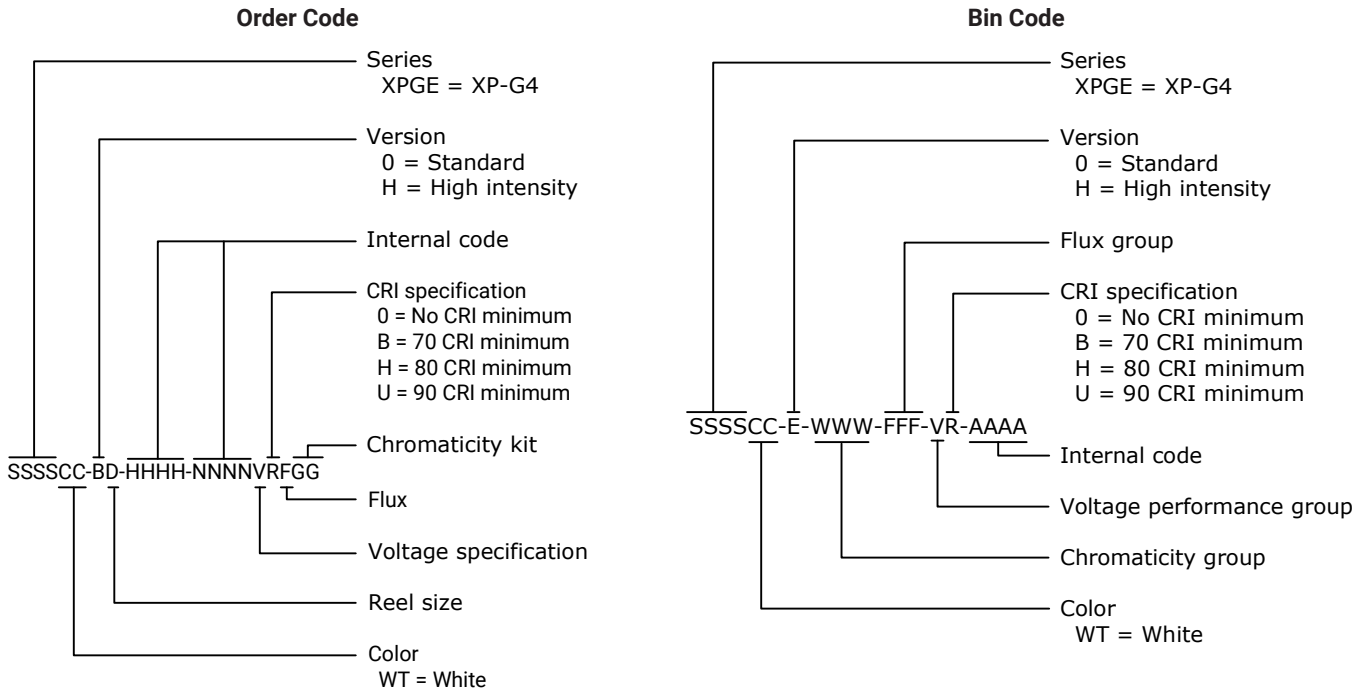

REFLOW SOLDERING CHARACTERISTICS

In testing, Cree LED has found XLamp XP-G4 LEDs to be compatible with JEDEC J-STD-020C, with the exception of the peak temperature requirements listed in the table below. As a general guideline, Cree LED recommends that users follow the recommended soldering profile provided by the manufacturer of the solder paste used, and therefore it is the lamp or luminaire manufacturer’s responsibility to determine applicable soldering requirements.

Note that this general guideline may not apply to all PCB designs and configurations of reflow soldering equipment.

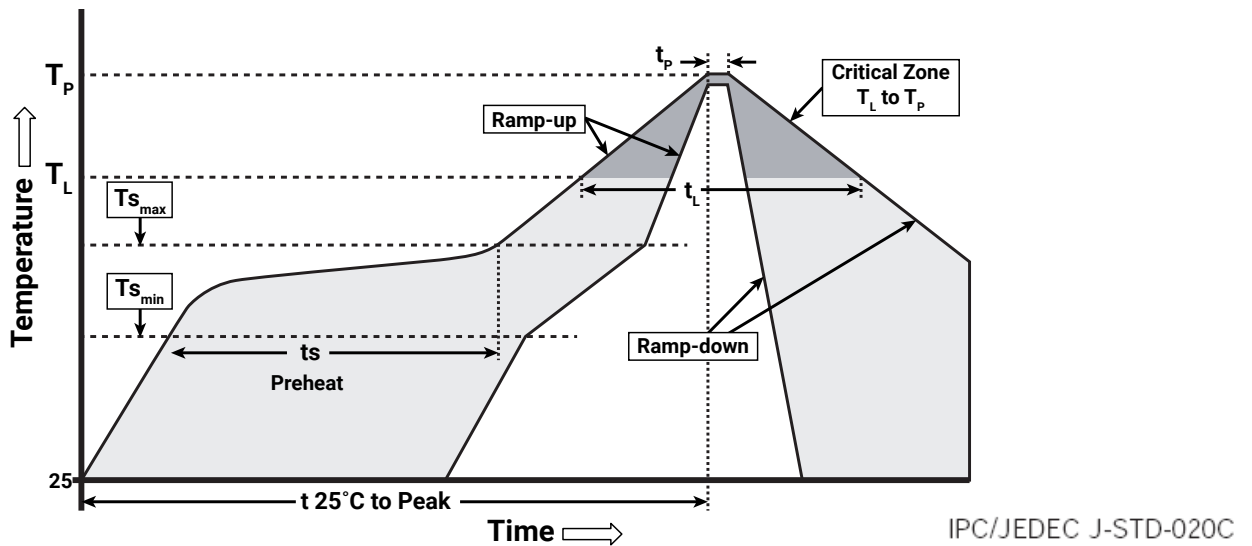

Profile Feature	Lead-Free Solder
Average Ramp-Up Rate ($T_{s_{max}}$ to T_p)	1.2 °C/second
Preheat: Temperature Min ($T_{s_{min}}$)	120 °C
Preheat: Temperature Max ($T_{s_{max}}$)	170 °C
Preheat: Time ($t_{s_{min}}$ to $t_{s_{max}}$)	65-150 seconds
Time Maintained Above: Temperature (T_L)	217 °C
Time Maintained Above: Time (t_L)	45-90 seconds
Peak/Classification Temperature (T_p)	235 - 245 °C
Time Within 5 °C of Actual Peak Temperature (t_p)	20-40 seconds
Ramp-Down Rate	1 - 6 °C/second
Time 25 °C to Peak Temperature	4 minutes max.

Note: All temperatures refer to topside of the package, measured on the package body surface.

NOTES

Measurements

The luminous flux, radiant power, chromaticity, forward voltage and CRI measurements in this document are binning specifications only and solely represent product measurements as of the date of shipment. These measurements will change over time based on a number of factors that are not within Cree LED's control and are not intended or provided as operational specifications for the products. Calculated values are provided for informational purposes only and are not intended or provided as specifications.

Pre-Release Qualification Testing

Please read the [LED Reliability Overview](#) for details of the qualification process Cree LED applies to ensure long-term reliability for XLamp LEDs and details of Cree LED's pre-release qualification testing for XLamp LEDs. Cree LED did not perform Room Temperature Operating Life (RTOL) testing on the XP-G4 LED.

Lumen Maintenance

Cree LED now uses standardized IES LM-80-08 and TM-21-11 methods for collecting long-term data and extrapolating LED lumen maintenance. For information on the specific LM-80 data sets available for this LED, refer to the public [LM-80 results document](#).

Please read the [Long-Term Lumen Maintenance application note](#) for more details on Cree LED's lumen maintenance testing and forecasting. Please read the [Thermal Management application note](#) for details on how thermal design, ambient temperature, and drive current affect the LED junction temperature.

Moisture Sensitivity

Cree LED recommends keeping XLamp LEDs in the provided, resealable moisture-barrier packaging (MBP) until immediately prior to soldering. Unopened MBPs that contain XLamp LEDs do not need special storage for moisture sensitivity.

Once the MBP is opened, XLamp XP-G4 LEDs may be stored as MSL 1 per JEDEC J-STD-033, meaning they have unlimited floor life in conditions of ≤ 30 °C/85% relative humidity (RH). Regardless of the storage condition, Cree LED recommends sealing any unsoldered LEDs in the original MBP.

RoHS Compliance

The levels of RoHS restricted materials in this product are below the maximum concentration values (also referred to as the threshold limits) permitted for such substances, or are used in an exempted application, in accordance with EU Directive 2011/65/EC (RoHS2), as implemented January 2, 2013. RoHS Declarations for this product can be obtained from your Cree LED representative or from the [Product Ecology](#) section of the Cree LED website.

REACH Compliance

REACH substances of very high concern (SVHCs) information is available for this product. Since the European Chemical Agency (ECHA) has published notice of their intent to frequently revise the SVHC listing for the foreseeable future, please contact a Cree LED representative to insure you get the most up-to-date REACH Declaration. REACH banned substance information (REACH Article 67) is also available upon request.

NOTES - CONTINUED

UL® Recognized Component

This product meets the requirements to be considered a UL Recognized Component with Level 4 enclosure consideration. The LED package or a portion thereof has been investigated as a fire and electrical enclosure per ANSI/UL 8750.

Vision Advisory

WARNING: Do not look at an exposed lamp in operation. Eye injury can result. For more information about LEDs and eye safety, please refer to the [LED Eye Safety application note](#).

MECHANICAL DIMENSIONS (T_A = 25 °C)

Thermal vias, if present, are not shown on these drawings.

All measurements are ±.13 mm unless otherwise indicated.

XP-G4 Standard

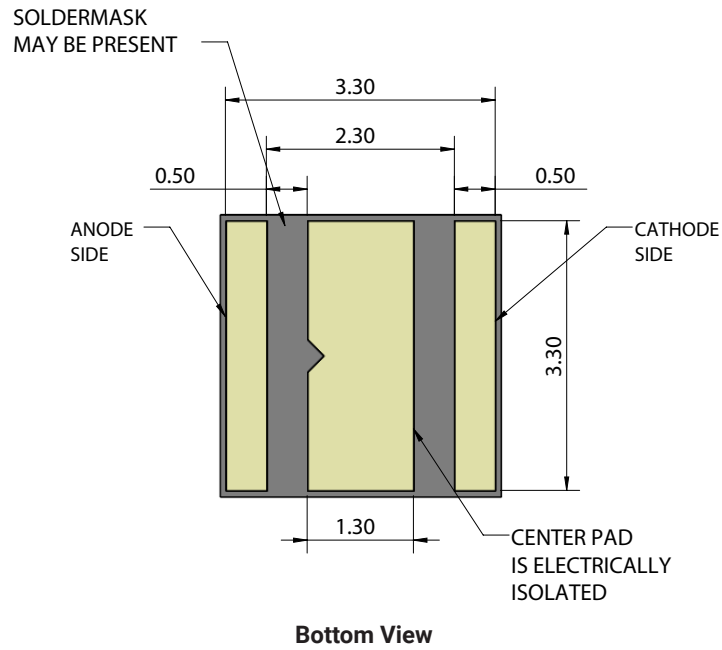
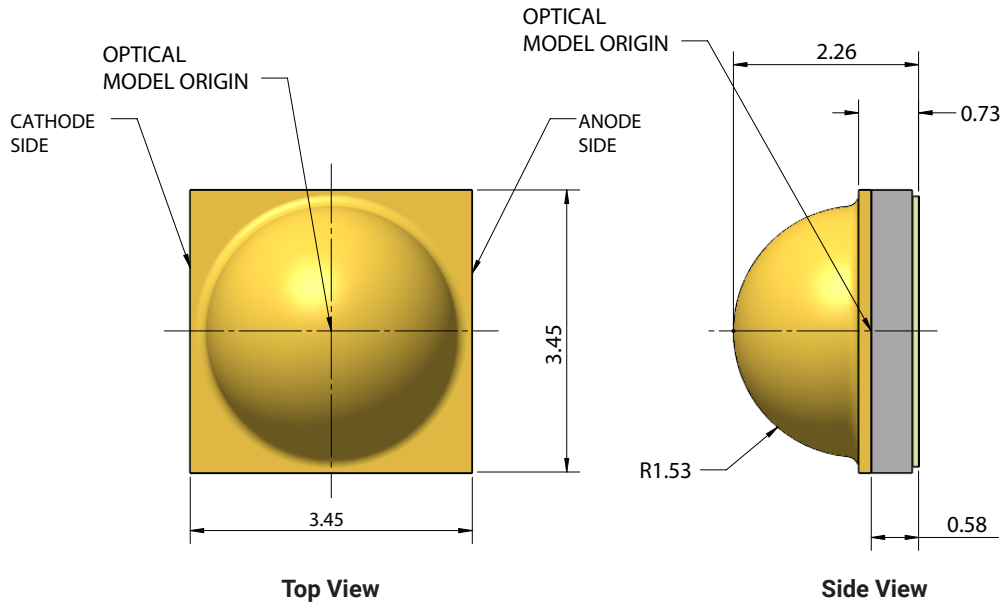

MECHANICAL DIMENSIONS (T_A = 25 °C) - CONTINUED

Thermal vias, if present, are not shown on these drawings.

All measurements are ±.13 mm unless otherwise indicated.

XP-G4 High Intensity

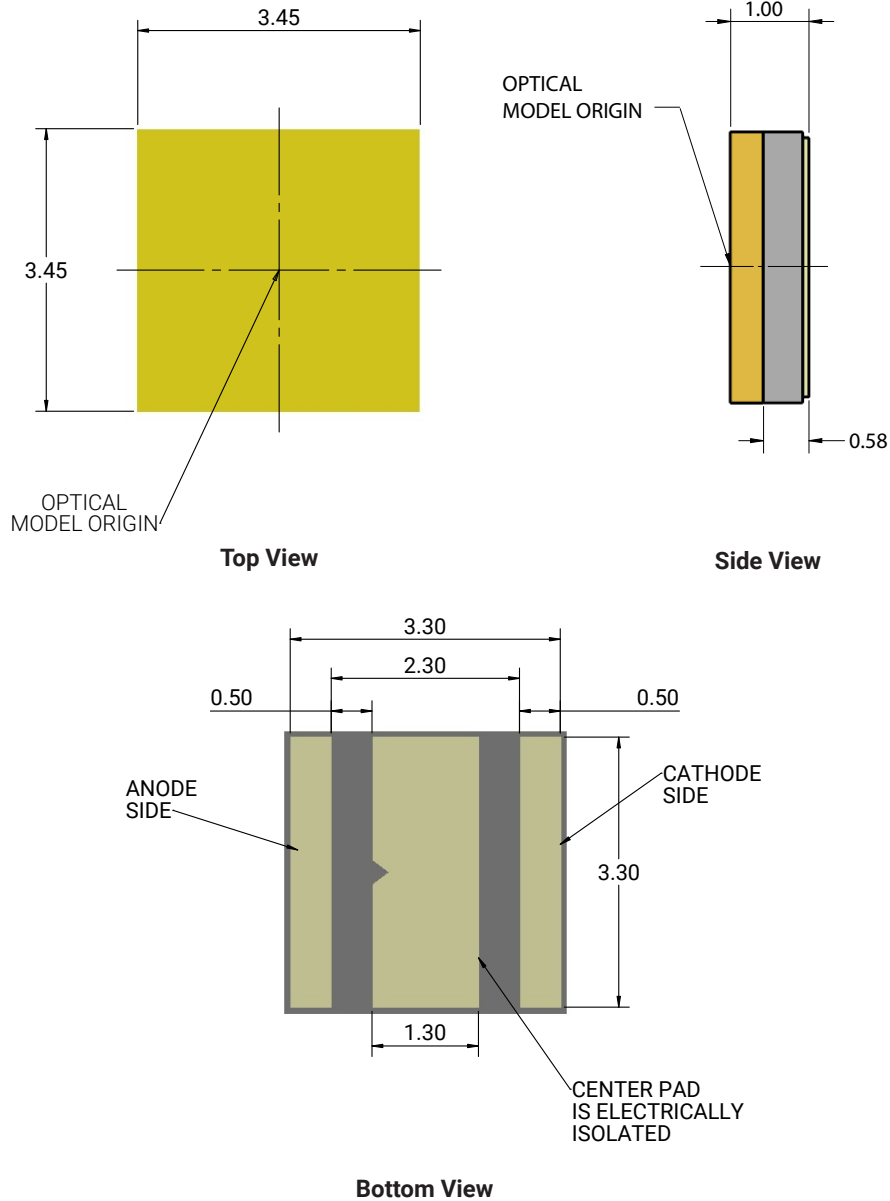

TAPE AND REEL

All Cree LED carrier tapes conform to EIA-481D, Automated Component Handling Systems Standard.

All dimensions in mm.

All measurements are ± 0.15 mm unless otherwise indicated.

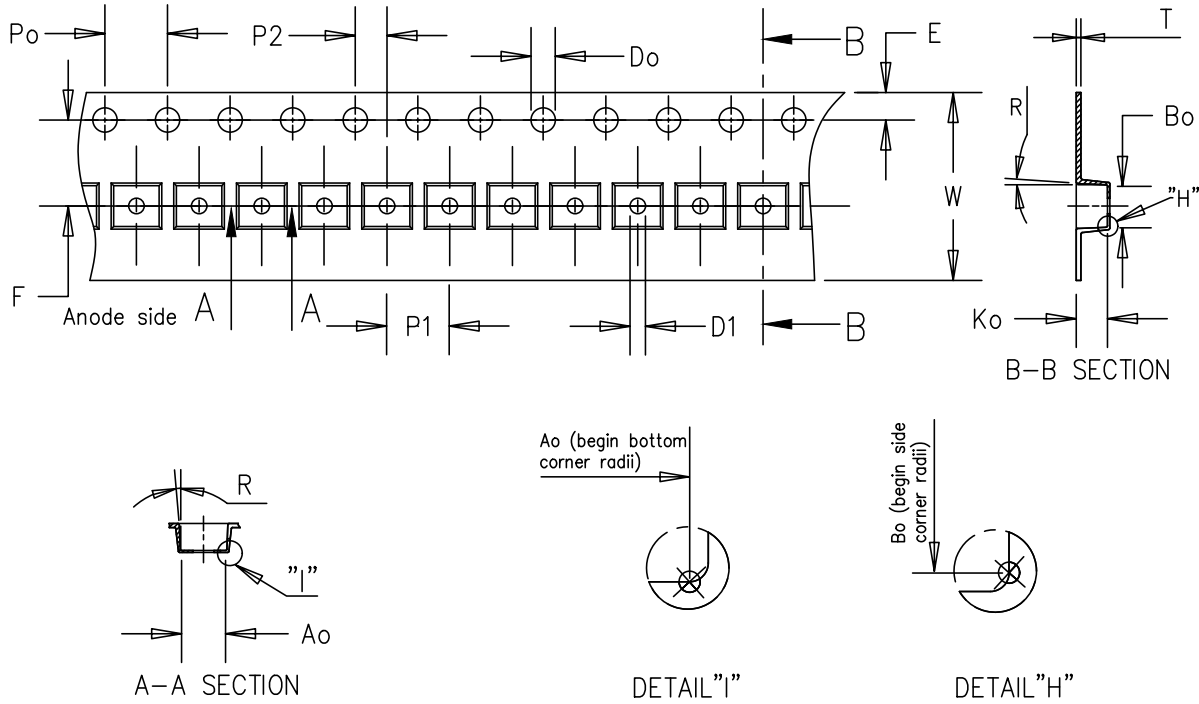

XP-G4 Standard

Item	Ao	Bo	Ko	Po	P1	P2	T	E	F	Do	D1	W	R
Dim.	3.70	3.70	2.40	4.00	8.00	2.00	0.30	1.75	5.50	1.55	1.50	12.00	5°

XP-G4 High Intensity

Item	Ao	Bo	Ko	Po	P1	P2	T	E	F	Do	D1	W	R
Dimension	3.70	3.70	1.20	4.00	8.00	2.00	0.30	1.75	5.50	1.50	1.50	12.00	3°

TAPE AND REEL - CONTINUED

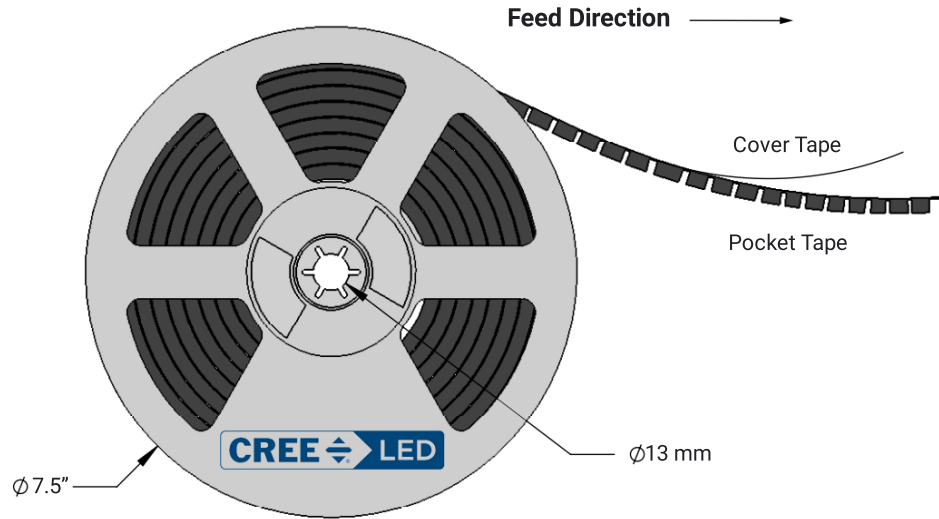
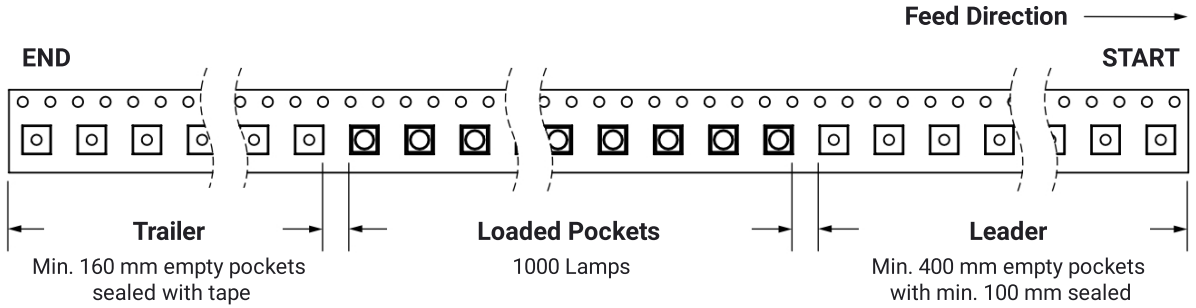

PACKAGING

Unpackaged Reel

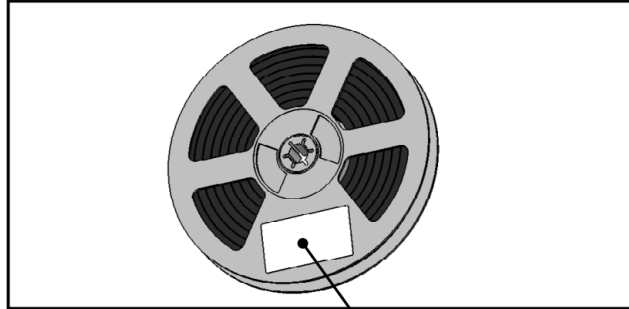

Label with Cree LED Bin Code, Quantity, Reel ID

Packaged Reel

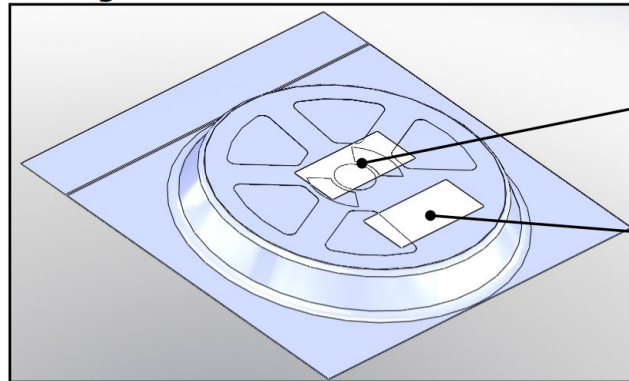

Label with Cree LED Order Code, Quantity, Reel ID, PO#

Label with Cree LED Bin Code, Quantity, Reel ID

Boxed Reel

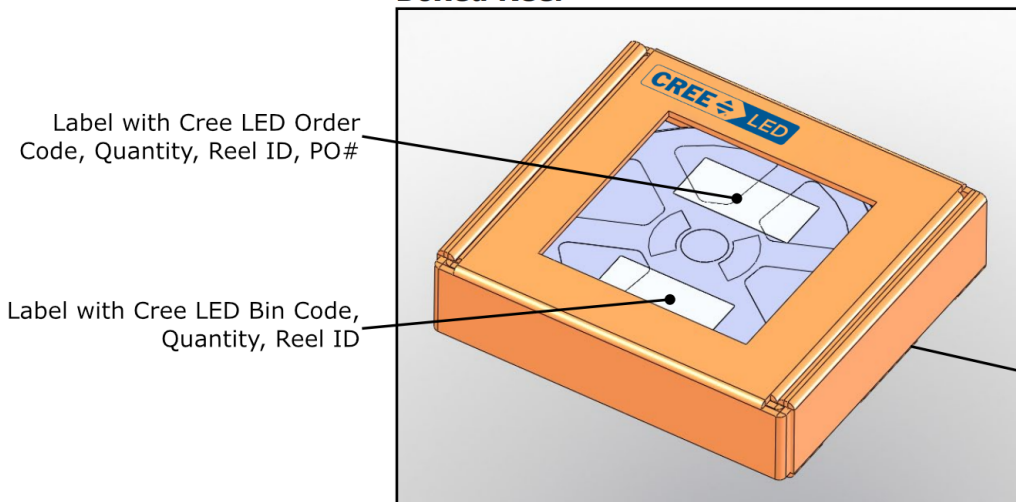

Label with Cree LED Order Code, Quantity, Reel ID, PO#

Label with Cree LED Bin Code, Quantity, Reel ID

Patent Label (on bottom of box)