

THIS DOCUMENT IS SUBJECT TO CHANGE WITHOUT NOTICE. IT IS CONFIDENTIAL AND A PROPERTY OF Amphenol LTW. DISCLOSURE TO THIRD PARTY HAS TO BE AUTHORIZED BY Amphenol LTW.

REV.	ECN NO.	DATE	SIGN	DESCRIPTION
B	LEN1780899~900	2017-08-09	Frank Deng	Add Package

ALTW
CONFIDENTIAL
2017-08-09
R&D DEPT.

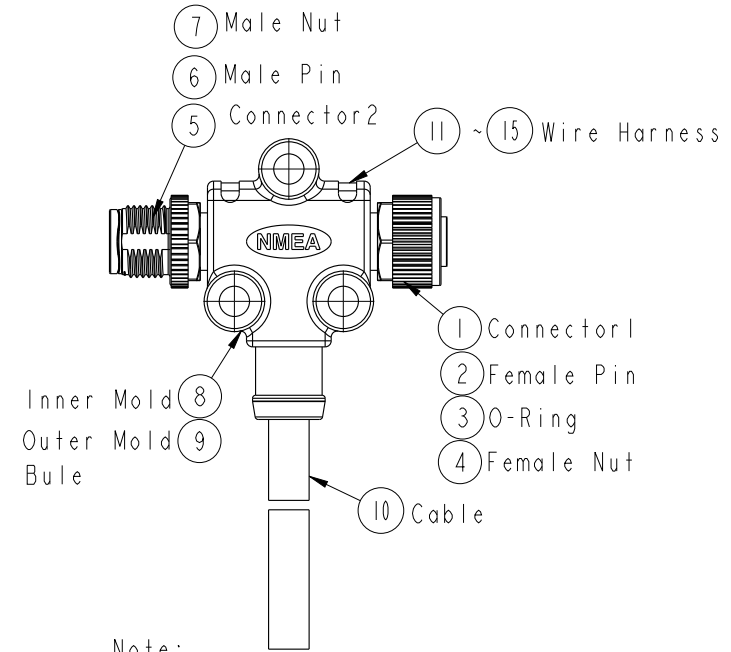
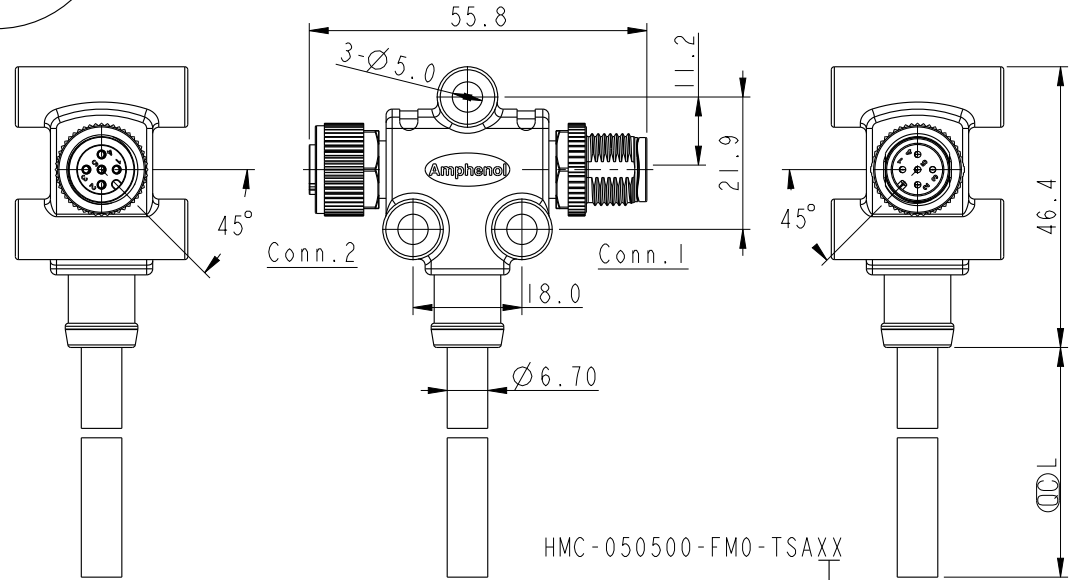
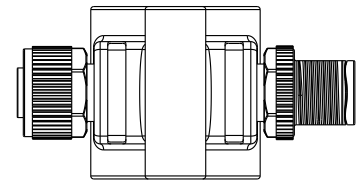

ALTW
DCC. DEPT.
CONFIDENTIAL
2017.08.17
ISSUED

XX: 01~99Meters
01: 01Meter
02: 02Meters
99: 99Meters
Cable Length(L): 01~99Meters

Note:
 * \varnothing Important Dimension To Check.
 * Waterproof Rate: IP68
 In 1 meter water within 24 hours
 * Connector: PU, Black
 * Nut: Zinc Alloy, Nickel Plated
 * Pin: Copper Alloy, Gold Plated 30u"
 * Outer Mold: PU, Blue
 * Wire Harness: UL1061, 22AWG
 * Cable: CL2, (24#*IP+A/M)+(22#*IP+A/M)+D+B, PVC UV Cable, OD=6.7mm, Black
 * Cable Length Tolerance: 01M:±40mm
 02M~05M:±60mm
 06M~10M:±100mm
 11M~30M:±200mm
 31M~99M:±500mm

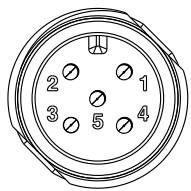

Conn.1
Pin Assignments
Front View

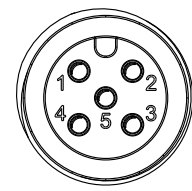

Conn.2
Pin Assignments
Front View

5	Blue 藍	5	Blue 藍 24#	Twist
4	White 白	4	White 白 24#	
3	Black 黑	3	Black 黑 22#	Twist
2	Red 紅	2	Red 紅 22#	
1	Green 綠	1	Drain 22#	
Conn.1	Wire Color	Conn.2	Cable	

Pin Out

UNIT:mm
TOLERANCE ±0.50mm

TITLE NMEA2000 Micro-C T Cable			
SCALE 1:2	SIZE A4	SHEET 1 OF 2	
REV. B	WC-REV. A.1	QC: Inspection item	

Amphenol LTW
安費諾亮泰企業股份有限公司

ITEM NO	DRAWN BY Frank Deng	DATE 2017-08-09
DWG NO HMC-050500-FM0-TSAXX	CHECKED BY Fisher Wang	DATE 2017-08-09
CUSTOMER ALTW	APPROVED BY Kevin Hu	DATE 2017-08-09

THIS DOCUMENT IS SUBJECT TO CHANGE WITHOUT NOTICE. IT IS CONFIDENTIAL AND A PROPERTY OF AMPHENOL LTW. DISCLOSURE TO THIRD PARTY HAS TO BE AUTHORIZED BY AMPHENOL LTW.



1 2 3 4 5 6 7 8

F
E
D
C
B
A



PN	Dimension Of Roll
HMC-050500-FM0-TSA02	
HMC-050500-FM0-TSA05	
HMC-050500-FM0-TSA10	



UNIT:mm  

TITLE NMEA2000 Micro-C T Cable			
SCALE 1:2	SIZE A4	SHEET 2 OF 2	
REV. B	WC-REV. A.1	QC: Inspection item	

Amphenol LTW
安費諾亮泰企業股份有限公司

ITEM NO	DRAWN BY Frank Deng	DATE 2017-08-09
DWG NO HMC-050500-FM0-TSAXX	CHECKED BY Fisher Wang	DATE 2017-08-09
CUSTOMER ALTW	APPROVED BY Kevin Hu	DATE 2017-08-09

1 2 3 4 5 6 7 8 FMW10702-01-02A1