

Cree® XLamp® LED Electrical Overstress

TABLE OF CONTENTS

Introduction	1
Causes of Electrical Overstress	2
Effects of Electrical Overstress on XLamp® LEDs	3
Classes of Electrical Overstress Protection Devices.....	4
Active Protection Circuits.....	8
Conclusion.....	9
Useful Links.....	9

INTRODUCTION

This application note describes electrical overstress (EOS) events, their effect on Cree XLamp® LEDs and various methods of protecting XLamp LEDs against EOS. Electrical overstress is simply exposing an LED to any current exceeding the maximum current specified in the LED’s data sheet. Depending on the duration and amplitude of the exposure, the effect on the LED varies in severity. What is certain is that any single EOS event has the potential to damage an LED. This damage might result in an immediate failure or in a gradual failure many hours after the event. Therefore all necessary precautions should be taken to avoid EOS events.

This application note assumes that primary protection circuits or devices are already implemented in the power supply or driver¹ in addition to other protection systems that prevent damage from lightning strikes, power surges, and so on. This application note focuses on secondary protection circuits to protect LEDs against commonly seen EOS events. Please note that this document is not a complete guide to secondary protection circuits.

¹ The terms power supply and driver are used interchangeably in this document.

CAUSES OF ELECTRICAL OVERSTRESS

The most common causes of electrical overstress of LEDs are described below.

1. ESD events

ESD is a widely recognized hazard during manufacturing, shipping and handling of many semiconductor devices, including LEDs. Nearly all Cree XLamp LEDs contain ESD protection devices and are classified as class 2 in the MIL-STD-883 Human Body Model, meaning they survive ESD events up to 2 kV. Although XLamp LEDs have protection, it is still possible to induce EOS damage due to ESD events if proper handling procedures are not followed. One troublesome aspect of ESD events is that they sometimes do not cause an immediate catastrophic failure. Instead, these latent failures become catastrophic hundreds or thousands of hours after the ESD event.

2. Transient over-current events

Transient over-current events subject one or more LEDs to current that is higher than the maximum rated current on the LED data sheet, either directly through high current or indirectly through high voltage. These events are transient, meaning they happen for a short period of time – typically less than one second. They are sometimes referred to as surges or spikes, such as a “current spike” or “voltage spike.”

An over-current event that occurs during the initial time period when the LED turns on is commonly referred to as inrush current. This effect is typically caused when the capacitors in a driver circuit are initially energized. An overshoot can be seen by observing the output current to the LED. One way to avoid this problem is to implement a soft-start algorithm to control how quickly the capacitors are charged and avoid instantaneous surges in current. A comparison of the outputs from two different drivers with and without soft-start are shown in Figure 1 and Figure 2.

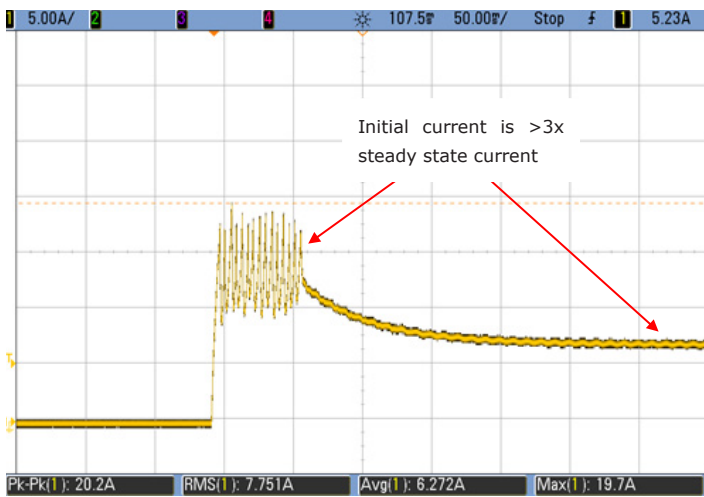

Figure 1: Inrush current with overshoot

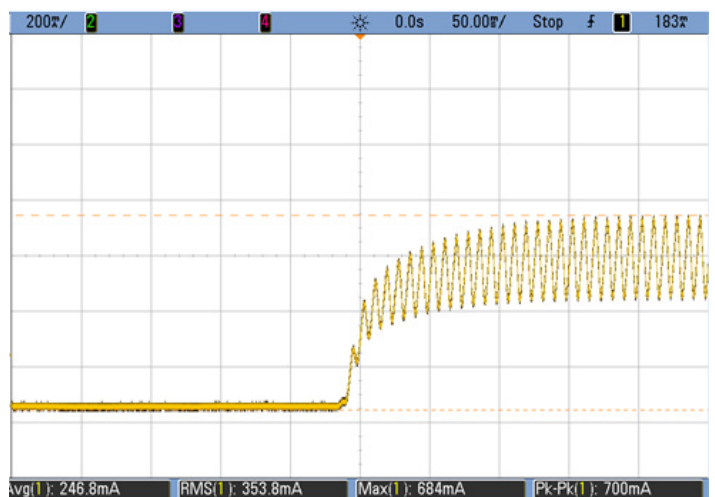

Figure 2: Inrush current with soft start

Another common over-current event is known as hot-plugging. This can happen when an LED is plugged into an energized power supply that has the output voltage at a level greater than the forward voltage for the LED load. For example, if a single LED normally has a forward voltage of 3 V at 350 mA, and the output of the power supply is floating at 24 V with no load, it is possible for a surge current to flow through the LED until the supply’s current-limiting circuitry reacts. Figure 3 illustrates this point.

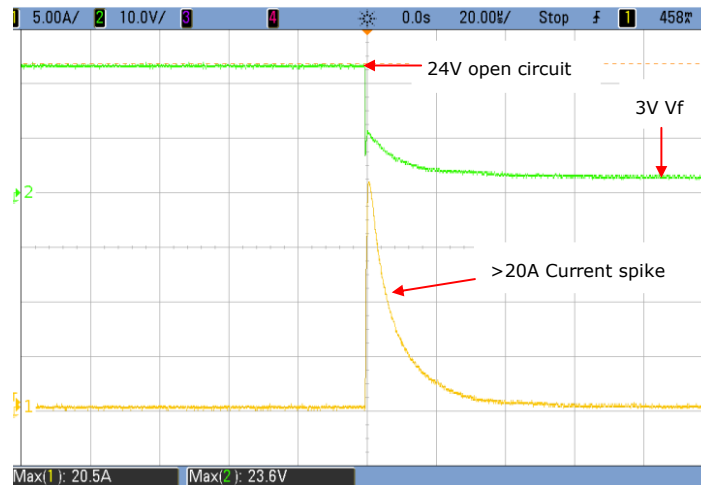

Figure 3: Hot-plugging example

When selecting an off-the-shelf driver, it is important to check the specifications and verify the maximum output voltage and also check if it employs soft-start protection. In addition, it is a good idea to validate that the driver performs as specified by testing it thoroughly under various input and loading conditions. It is also important to make sure that robust connections are maintained between the driver and LED load. It is possible for connections to become intermittent due to mechanical vibration, thermal expansion/contraction or solder-joint fatigue.

3. Over-driving the LED

An LED is over-driven when the current applied to the LED exceeds the LED’s specified current rating. For example, the XLamp XP-G LED has a maximum continuous current rating of 1.5 A. In some cases for specific applications, it may be desirable to pulse the LED at currents above this rating. Because this is a design choice made for the LED driver circuit, this application note does not address protection methods for this type of overstress. A Cree application note, [Pulsed Over-Current Driving of Cree XLamp LEDs: Information and Cautions](#), deals more specifically with this scenario.

4. Reverse voltage

Unlike many other LEDs on the market, most XLamp LEDs are capable of withstanding application of reverse voltage equal to the forward voltage of the device. In other words, if the LED load is connected with reverse polarity to a power supply with an output voltage less than or equal to the forward voltage of the LED load, the LED will not be damaged. If, however, the LED is subjected to higher levels of reverse voltage, i.e., greater than several times the forward voltage rating, the LED can be permanently damaged. Be sure to review the data sheet for each LED to determine its reverse voltage and/or current rating. If the information is not available in the data sheet, [contact](#) a Cree technical staff member for support.

EFFECTS OF ELECTRICAL OVERSTRESS ON XLAMP® LEDS

Latent failures

Detecting damage to an LED subjected to EOS can be difficult. The damage is often not immediate and catastrophic and therefore goes undetected because the LED continues to produce light. However, changes to an LED’s electrical parameters can be detected by measuring forward and reverse bias currents of the suspect LED. For example, a normal XLamp XP-E LED draws a reverse current of no

less than $-3 \mu\text{A}$ at -10 V . An LED that has been damaged by EOS can become “leaky” and its reverse current will increase (in absolute terms). In other words, an XP-E LED would be considered “leaky” if the measured reverse current was $-10 \mu\text{A}$. Each XLamp LED device type has specific limits for reverse current.

Catastrophic failures

Catastrophic failures are usually easy to detect because the LED no longer produces light, although in a large array, a single failed LED may not be noticed. Two common symptoms, described below, are observed on XLamp LEDs that have catastrophically failed due to an EOS event. These can be seen by inspecting the LED under magnification. Other symptoms are not easily seen unless the LED package is de-processed and the bare chip is examined under advanced analysis techniques.

Damage near bond pads

When the EOS event is not severe, damage will be seen near the bond pads, as shown in Figure 4. Normally LEDs that have failed in this manner will measure as a short circuit when tested with an ohmmeter or curve tracer. This is the most common EOS failure mode and the reason that nearly all EOS failures fail in the short circuit mode.

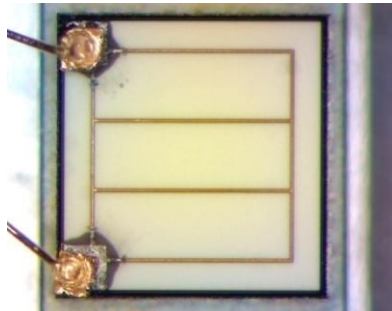

Figure 4: LED chip with damaged bond pads

CLASSES OF ELECTRICAL OVERSTRESS PROTECTION DEVICES

There are two main categories of devices that help protect LEDs from electrical overstress: overvoltage protection and current limiting. The function of these devices is to absorb electrical energy that would otherwise be dissipated in the load and cause permanent damage. A third category is reverse voltage protection, which includes components such as barrier diodes that block current from flowing in the reverse direction if the load is connected backwards.

Overvoltage protection devices

Overvoltage protection devices are connected in parallel to the electronic load, as shown in Figure 5. These devices are designed so that they do not conduct current until a certain threshold voltage is reached. The two most common type of devices are metal-oxide varistors (MOV) and transient-voltage suppressors (TVS). Gas-discharge tubes (GDT) are also another frequently used type of voltage-suppression device, however these are normally used on the AC mains input and therefore are not within the scope of this document.

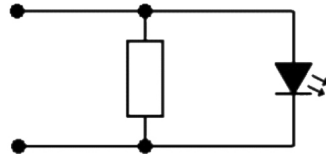

Figure 5: Overvoltage protection in parallel with LED

MOVs are voltage-dependent resistive devices that are designed to protect electronic loads from high-amplitude, short-duration voltage spikes. They are typically used on the input side of a driver circuit, but they can also be used on the output side.

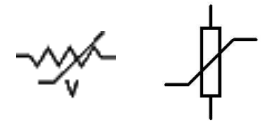

Figure 6: MOV symbols

TVS devices are typically silicon-based diodes and may be unidirectional or bidirectional. TVS diodes also are used for fast transient events, including ESD events, and tend to have faster response times than MOVs, however their clamping voltage ratings tend to be much lower than those of MOVs, thus multiple devices may be required for longer chains of LEDs. Figure 7 shows the schematic symbol for a bidirectional device.



Figure 7: TVS symbol

Either type of device, MOV or TVS, can only protect against short-duration events. Longer-duration, higher-energy events will result in the device overheating and failing which will in turn lead to eventual EOS damage to the LED load. Also, these devices may not protect the LEDs from overvoltage events that are above the forward voltage of the LEDs, but below the clamping voltage. Therefore it is important to specify these devices carefully.

Current-limiting devices

Current-limiting devices are connected in series to the electronic equipment to be protected. As the name suggests, these devices are designed to hold the current flow to a specified limit or to break the circuit if a specified threshold limit is reached or exceeded.

Current-limiting devices are divided into two families: one-time devices and resettable devices. The most common type of one-time device is a fuse. Resettable devices are more desirable for use with LEDs as they do not need to be replaced in the event of a fault. An ideal current-limiting device has minimal power dissipation when the current is below the threshold level.

Table 1: Current-limiting device behavior

Device	Behavior
One-time devices	Create an open circuit during an EOS event. The device must be replaced to restore the circuit to its original condition.
Resettable devices	Change the resistance value during an EOS event. Removing the EOS or switching off the power supply restores the device to its original state.

Use of positive temperature coefficient resistors to limit current

Positive temperature coefficient (PTC) resistors, also called thermistors, are electrical devices that increase their resistance when temperature increases, either through the device’s own power dissipation or by an increase in ambient temperature. A PTC device in series with an LED array, as shown in Figure 8, decreases the current to the LEDs in an over-current situation.

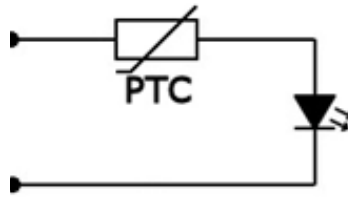

Figure 8: PTC resistor in series with LED

The maximum voltage, maximum current and maximum ambient temperature of the LED array should be considered to help select the appropriate PTC device product family. Next, the rated current of the product family should be de-rated according to the maximum ambient temperature to select the specific product that will remain off under normal operating conditions.

Using PTC resistors for current limiting has challenges. PTC devices must warm up to provide over-current protection, which can take tens of milliseconds or longer before the resistance increases and begins to limit the flow of current. Second, once the device is warmed up, it will not provide protection again until it cools back down. Based on these challenges, the use of PTC resistors for over-current protection is most useful when the normal operating current is small relative to the maximum current of the LEDs used.

Negative temperature coefficient resistors for inrush current protection

Negative temperature coefficient (NTC) resistors provide passive inrush current protection. NTC resistors are complementary devices to PTC resistors. Their resistance will decrease as temperature increases. NTC resistors come in two basic classes: high resistance and low resistance. High-resistance devices are commonly used for performing thermal measurements. Low-resistance devices are commonly used for inrush-current protection. Specifically, during a power supply hot-plug or initial power-up, the NTC devices present a high resistance value that protects the LEDs from inrush current. After the device’s transient time, the NTC resistor turns on and resistance becomes negligible.

Figure 9 shows an example of inrush current to a circuit without and with NTC device protection.

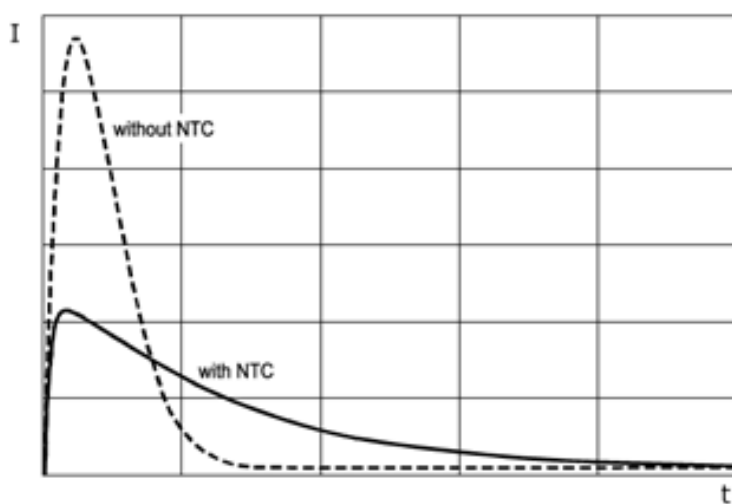

Figure 9: Inrush current example

Using NTC resistors for passive inrush current protection presents challenges. Once the device has heated up, it requires a cool down period before it can effectively absorb subsequent over-current events. Next, the energy dissipation of an NTC resistor reduces the total efficiency of the LED fixture. The amount of energy loss through the NTC resistor depends on ambient temperature and drive current used, but this loss can be significant, especially at low ambient temperatures. The NTC resistor may be a good solution with many LEDs in series and with a maximum power-supply voltage not much greater than the maximum forward voltage of the LED array.

Reverse Voltage Protection

One of the easiest ways to protect an LED load from reverse voltage is by putting a barrier diode in series. The reverse voltage rating of the diode should be greater than the maximum output voltage of the driver. A disadvantage of this approach is that additional power is dissipated in the diode. Figure 10 gives an example of an LED circuit with a Schottky diode, which has a lower forward-voltage drop than a standard diode.

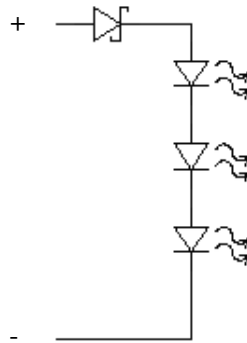

Figure 10: Schottky barrier diode in LED circuit

In most applications adding a barrier diode is not necessary.

Combination Devices

A new class of device has been developed recently that combines a PTC resistor with an TVS in a single package. This type of device can provide over-current protection as well as overvoltage and reverse-voltage protection. An example is shown in Figure 11.²

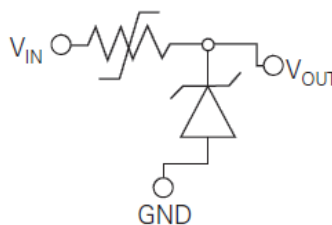

Figure 11: Combination protection device

² Image from TE Connectivity, PolyZen Devices Polymer Protected Zener Diode, www.te.com/catalog/pn/en/RF1500-000?RQPn=ZEN056V075A48LS

ACTIVE PROTECTION CIRCUITS

For power supplies with high maximum output voltages or with requirements for the highest possible efficacy, active over-current protection may be a better option than using passive devices. Active protection circuits have on-state resistance of just a few milliohms (instead of several ohms) and reset within milliseconds instead of minutes. In addition, active protection can be effective against other transient events that can occur during continuous operation and not just at turn-on.

One method of limiting current is known as fold-back. This involves implementing circuitry that detects when the threshold has been exceeded and then reduces the voltage to the load, which in turn reduces the current to the load, as shown in the curve in Figure 12. This technique is often used in linear power supplies.

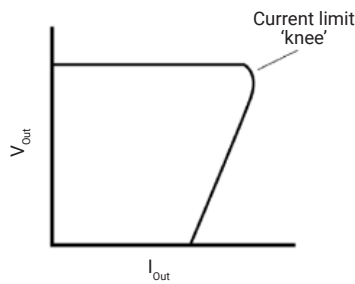

Figure 12: Fold-back current limiting

Another method, known as a crowbar circuit, involves using a thyristor device, such as a TRIAC or silicon-controlled rectifier (SCR). These circuits can be useful for high voltage loads. A crowbar circuit works by sensing a voltage that is above a certain threshold and activating a switching device, e.g., TRIAC or SCR, to shunt the current away from the load. This in turn activates a protection device such as a breaker or fuse.

A third method involves using a PMOS transistor circuit such as the one in Figure 13. A sensing resistor is used with a control circuit that either turns off the PMOS transistor or controls its gate voltage to limit the flow of current.

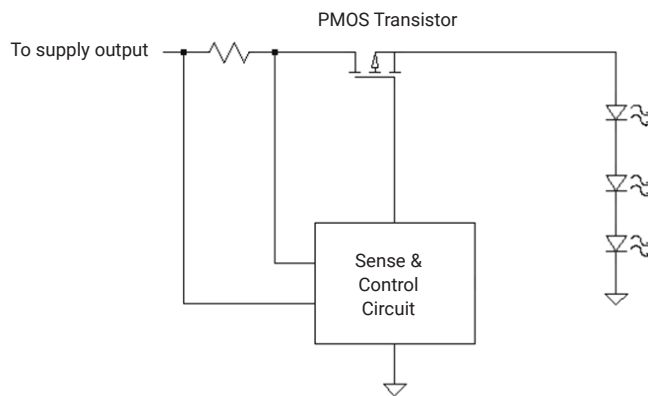

Figure 13: Load switch circuit

The addition of a few components can be very effective in protecting the LED array from a large current spike due to inrush or hot-plugging. The huge increase in end-product reliability could easily justify the small additional cost for the components.

CONCLUSION

Proper design of a luminaire or lamp as a system is the key to making a successful product in the growing LED lighting market. Most product designers are aware of good thermal, optical and electrical design principles, but might not have considered adding protection circuits to guard against improper usage or hot-plugging. Not every application needs electrical overstress protection, and adding such protection adds cost to the design and possibly decreases product efficiency.

Nevertheless, to minimize the risk of damage caused by hot-plugging, Cree strongly recommends adding some level of protection to LED luminaires or modules that do not include an on-board power supply. Installers accustomed to traditional lighting products might accidentally cause LED light fixture failures by hot-plugging the LED load to the power supply. The use of a simple, low-cost protection circuit can dramatically reduce the rate of returns from lighting customers. EOS, and hot-plugging in particular, is the most common problem Cree has observed in returned LEDs.

In addition, Cree recommends extensive testing of LED lamps and luminaires that includes surge immunity, power cycling and electromagnetic compliance. Far too often product developers rush to release unproven products to the market only to discover weeks or months later that their product has failed due to electrical overstress that could have easily been prevented with the addition of protection circuitry.

If you suspect your LEDs have been damaged by electrical overstress, please contact a member of Cree's technical support staff for assistance.

USEFUL LINKS

1. The following two-part video supplements this application note.

[Part 1](#) provides background information on EOS, common causes of this phenomenon and the effects it can have on LED reliability and performance.

[Part 2](#) demonstrates actual EOS events and simple methods of protecting LEDs from the damaging effects.

2. [Cree customer service](#) is available.